

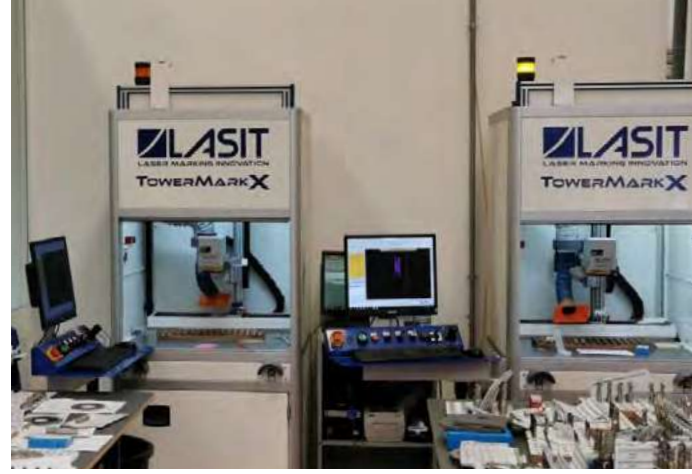

 **MICROTECH**®
HIGH PERFORMANCE TOOLS

 MADE IN ITALY 





PRODUZIONE DI UTENSILI IN DIAMANTE E HW POLICRISTALLINO PER LA LAVORAZIONE DEL LEGNO, POLIMERI E LEGHE LEGGERE.

La Microtech nasce nel 1980 dall'idea dei due soci fondatori Gabriele Borri e Orlando Carciofi.

Oggi è tra le prime aziende italiane produttrici di utensili in diamante policristallino e HW per la lavorazione del legno, derivati del legno, materiali plastici e leghe leggere.

I nostri prodotti vengono distribuiti in tutto il panorama nazionale ed internazionale.

L'esperienza maturata, la conoscenza tecnica, l'elevatissima concentrazione tecnologica sono da sempre il cuore dell'azienda.

LEADING MANUFACTURER OF PCD AND HW TOOLS FOR WORKING WOOD, WOODEN PRODUCT, POLYMERS AND LIGHT ALLOYS.

The Micortech was founded in 1980 with the idea of the two founders Gabriele Borri and Orlando Carciofi.

Today it is one of the first european companies producing HW and diamond tools for woodworking, wood products, plastics and light alloys.

Our products are distributed all over the national and international scene.

The experience, technical knowledge, the high concentration technology have always been the heart of the company.



INDICE INDEX

LAM	LAME E INCISORI - SEZIONATRICE SAW BLADES AND SCORING BLADES - SIZING	PAGINA PAGE	7	
TRC	TRUCIOLATORI - SQUADRATRICE HOGGERS - SQUARING	PAGINA PAGE	40	
FFD FFS	FRESE CON FORO - SQUADRATRICE BORDATRICE CUTTERS WITH BORE - SQUARING EDGEBANDING	PAGINA PAGE	45	
FPD	FRESE PANTOGRAFO DRITE STRAIGHT SHANK CUTTERS	PAGINA PAGE	90	
FPS	FRESE PANTOGRAFO SAGOMATE PROFILED SHANK CUTTERS	PAGINA PAGE	142	
PFO	PUNTE FORATRICI DRILLING BITS	PAGINA PAGE	175	
AEM	ATTACCHI E MANDRINI TOOL HOLDERS AND SLEEVES	PAGINA PAGE	197	
RIC	RICAMBI SPARE PARTS	PAGINA PAGE	212	

RICERCA QUI LA PAGINA RELATIVA AL TUO CODICE ARTICOLO

SEARCH HERE THE PAGE TO YOUR ITEM CODE

		Pag.			Pag.			Pag.
LAM		7	FFD4007		49	FFS5003		80
LAM1001	CUTPLUS 1	9	FFD4008		53	FFS5004		80
LAM1002	CUTPLUS 1	9	FFD4009		49	FFS5005		81
LAM1003	TOPCUT 1	10	FFD4010		53	FFS5006		81
LAM1004	TOPCUT 1	10	FFD4011		49	FFS5007		82
LAM1005	TOPCUT 2	14	FFD4012		53	FFS5008		82
LAM1006	TOPCUT 2	14	FFD4013		57	FFS5009		84
LAM1007	TOPCUT 3	17	FFD4014		49	FFS5010		84
LAM1008	TOPCUT 3	17	FFD4015		53	FFS5011		85
LAM1009	LAMELLO 1	19	FFD4016		49	FFS5012		85
LAM1010	MANUALCUT 1	21	FFD4017		53	FFS5013		86
LAM1011	FOLDINGCUT 1	18	FFD4018		57	FFS5014		87
LAM1012	FOLDINGCUT 1	18	FFD4019		60	FFS5015	V CUT 8	NEW 89
LAM1013	LAMELLO 2	20	FFD4020		49	FFS5016	JOINT CUT 2	NEW 88
LAM1514	CUTPLUS 2	22	FFD4021		53	FFS5017		NEW 88
LAM1515	CUTPLUS 3	23	FFD4022		49	FFS5018	MFX 10	NEW 83
LAM1516	TOPCUT 4	24	FFD4023		53	FPD		Pag. 90
LAM1517	TOPCUT 5	26	FFD4024		57	FPD2001	FULLCUT 1 EC1H	94
LAM1518	TOPCUT 6	27	FFD4025	LIGHT FLEX 1	60	FPD2003	FULLCUT 2 EC1HN	94
LAM1519	TOPCUT 7	28	FFD4026	LIGHT FLEX 2	62	FPD2004	FULLCUT 3 EC2H	95
LAM1520	TOPCUT 8	30	FFD4027	LIGHT FLEX 3	63	FPD2006	FULLCUT 4 EC2HN	95
LAM1521	TOPCUT 9	32	FFD4028		64	FPD2009	FULLCUT 5 EC2A	96
LAM1522	GROOVINGCUT 1	33	FFD4029		76	FPD2010	FULLCUT 6 EC2AN	97
LAM1523	TOPCUT 10	35	FFD4030	TRS 1	69	FPD2011	ECOCUT 1 EC2E	100
LAM1524	TOPCUT 11	37	FFD4031	TRS 2	70	FPD2012	ECOCUT 3 EC3E	101
LAM1525	LAMELLO 5	39	FFD4032	TRS 3	71	FPD2013	ECOCUT PLUS 1 RC3	101
TRC		Pag. 40	FFD4033	TRS 4	72	FPD2014	REFILCUT 2 EC3EB	104
TRC6001	TRCP	41	FFD4034	TRS 5	72	FPD2015	ECOCUT 6 EC4E	102
TRC6002	TRCN	42	FFD4035	GROOVINGCUT 2	74	FPD2016	ECOCUT PLUS 2 RC4	103
TRC6003	TRR	43	FFD4036	GROOVINGCUT 3	76	FPD2017	ECOCUT 8 EC4S	104
TRC6004	TRCG	44	FFD4037		77	FPD2020	ECX3	105
FFD - FFS		Pag. 45	FFD4038		77	FPD2021	RX3	105
FFD4001		49	FFD4040		78	FPD2024	ULTRACUT 1 UL	106
FFD4002		53	FFD4041	AIR CUT 2	65	FPD2025	ULTRACUT 2 ULC	106
FFD4003		49	FFD4042	AIR CUT 3	67	FPD2028	STARCUT 1 RX4	107
FFD4004		53	FFD4043	DIAFIX 1	NEW 68	FPD2029	STARCUT 3 RX4C	108
FFD4005		49	FFD4044		NEW 78	FPD2030	AIRCUT 1 RX6	113
FFD4006		53	FFD4045	TRS 6	NEW 73	FPD2033	STARCUT 4 RX4S	109
			FFD4046	GROOVINGCUT 4	NEW 75	FPD2034	STARCUT 5 RX4SC	110
			FFS5001		79	FPD2036	EXTREME 1 REX2	112
			FFS5002		79			

RICERCA QUI LA PAGINA RELATIVA AL TUO CODICE ARTICOLO

SEARCH HERE THE PAGE TO YOUR ITEM CODE

		Pag.			Pag.			Pag.
FPD2038	POWERCUT 2	99	FPD2518	AVANTECH 2	134	FPS3503	VARIO 2	NEW 155
FPD2039	POWERCUT 3	99	FPD2519	FINISH 11	NEW 140	FPS3504	V CUT 7	NEW 152
FPD2040	POWERCUT 5	114	FPD2520	FINISH 12	NEW 141	PFO		
FPD2041	POWERCUT 4N	115	FPD2521	AVANTECH 4	NEW 133			175
FPD2042	POWERCUT 4P	116	FPS		Pag.	PFO7001	PFO	177
FPD2043	POWERCUT 6N	117			142	PFO7002	PFL INFINITY 1	177
FPD2045	ECOCUT 5 EC3H	102	FPS3001	MXF 1	167	PFO7003	PFP INFINITY 2	178
FPD2046	FULLCUT 7 EC2HPN	98	FPS3002	MXF 2	168	PFO7004	PLC INFINITY 3	178
FPD2048	STARCUT 6 RX4B	118	FPS3003	MXF 3	169	PFO7005	PLCR INFINITY 5	179
FPD2049	ULTRACUT 3 ULB	118	FPS3004	MXF 4	170	PFO7006	PFS	180
FPD2050	STARCUT 7 TRPE	119	FPS3005	MXF 5	171	PFO7007	PLC INFINITY 4	NEW 181
FPD2052	AVANTECH 1 FRESA PER CAVE SERRATURE DI PORTE	124	FPS3006	MXF 6	172	PFO7501	FOUR LINE	182
FPD2053	ECOCUT 2 EC2EH HDM	100	FPS3008	T-SLOT	145	PFO7502	FOUR LINE	182
FPD2054	POWERCUT 5A	114	FPS3009	LAMELLO 3	146	PFO7503	FOUR LINE	182
FPD2055	REFILCUT1 RIFILATORE	98	FPS3010	JOINT CUT 1	148	PFO7504	FOUR LINE	182
FPD2056	SPACE 2	123	FPS3011	V CUT 1	149	PFO7505	FOUR LINE	182
FPD2057	STARCUT 2 RX4	108	FPS3012	V CUT 2	150	PFO7506	FOUR LINE	182
FPD2058	POWERCUT 4NA	115	FPS3013	V CUT 3	151	PFO7507	TWO LINE	184
FPD2059	POWERCUT 8N	116	FPS3014	V CUT 4	156	PFO7508	TWO LINE	184
FPD2060	EXTREME 2 TRPX	120	FPS3015	V CUT 5	157	PFO7509	TWO LINE	184
FPD2061	SPACE 3	123	FPS3016	RADIUS 1	158	PFO7510	R-LINE	185
FPD2062	AVANTECH 2	NEW 125	FPS3017	RADIUS 2	159	PFO7511	R-LINE	185
FPD2063	STATCUT 9	NEW 121	FPS3018	PROFILE 1	162	PFO7512	POWER LINE	186
FPD2064	STARCUT 8	NEW 111	FPS3019	PROFILE 2	162	PFO7513	POWER LINE	186
FPD2501	FINISH 1	126	FPS3020	PROFILE 3	163	PFO7514	EXTREME	187
FPD2502	FINISH 2	127	FPS3021	PROFILE 4	163	PFO7515	PLCH	187
FPD2503	FINISH 3	128	FPS3022	PROFILE 5	164	PFO7516	PLCH	187
FPD2504	FINISH 4	129	FPS3023	PROFILE 6	164	PFO7517	PLCH	187
FPD2505	FINISH 5	130	FPS3024	PROFILE 7	165	PFO7518	FLINE L	189
FPD2506	RAPTOR 1	131	FPS3025	PROFILE 8	165	PFO7519	FLINE L	189
FPD2507	FINISH 6	132	FPS3026	PROFILE 9	166	PFO7520	FLINE L	189
FPD2508	RAPTOR 2	135	FPS3027	PROFILE 10	166	PFO7521	TLINE L	190
FPD2509	FINISH 7	136	FPS3028	RADIUS 3	160	PFO7522	TLINE L	190
FPD2510	RAPTOR 3	136	FPS3029	RADIUS 4	161	PFO7523	TLINE L	190
FPD2511	FINISH 8	137	FPS3030	LAMELLO 6	NEW 147	PFO7524	TLINE 2L	191
FPD2512	RAPTOR 4	137	FPS3031	MXF 8	NEW 173	PFO7525	TLINE 2L	191
FPD2514	FINISH 9	138	FPS3032	MXF 9	NEW 174	PFO7526	TLINE 2LH	192
FPD2516	POWERCUT 7W	139	FPS3033	V CUT 6	NEW 153	PFO7527	TLINE 2LH	192
FPD2517	SPACE 1 HW	122	FPS3034	RADIUS 5	NEW 153	PFO7528		195
			FPS3501	LAMELLO 4	146	PFO7529		195
			FPS3502	VARIO 3	NEW 154	PFO7530		196

RICERCA QUI LA PAGINA RELATIVA AL TUO CODICE ARTICOLO

SEARCH HERE THE PAGE TO YOUR ITEM CODE

	Pag.		Pag.		Pag.
PFO7531	196	AEM8039	203	RIC9036	224
PFO7532 SVP SVASATORE PIANE	193	AEM8040	204	RIC9037	224
PFO7533 SVP SVASATORE PIANE	193	AEM8041	209	RIC9038	224
PFO7534 SLV	194	AEM8042	206	RIC9039	224
AEM	197	AEM8043	201	RIC9045	NEW 218
AEM8001	201	AEM8044	204	RIC9046 DIAREX	NEW 215
AEM8002	202	AEM8046	NEW 203		
AEM8003	202	AEM8047	NEW 209		
AEM8004	202	AEM8048	NEW 206		
AEM8005	204	RIC	Pag. 212		
AEM8006	204	RIC9001	216		
AEM8007	207	RIC9004 COL SAG	219		
AEM8008	207	RIC9007	228		
AEM8009	207	RIC9008	221		
AEM8010	207	RIC9009	227		
AEM8011	207	RIC9010	217		
AEM8012	208	RIC9012	217		
AEM8013	208	RIC9013	216		
AEM8014	208	RIC9014	218		
AEM8015	208	RIC9015	225		
AEM8016	209	RIC9016	218		
AEM8017	209	RIC9017	227		
AEM8018	209	RIC9018	227		
AEM8019	209	RIC9019	220		
AEM8020	200	RIC9020	221		
AEM8021	211	RIC9021	221		
AEM8022	211	RIC9022	221		
AEM8023	210	RIC9023	221		
AEM8024	210	RIC9024	222		
AEM8025	210	RIC9025	222		
AEM8026	210	RIC9026	222		
AEM8027	210	RIC9027	222		
AEM8028	211	RIC9028	224		
AEM8029	211	RIC9029	222		
AEM8030	206	RIC9030	222		
AEM8032	203	RIC9031	223		
AEM8033	205	RIC9032	223		
AEM8037	201	RIC9033	223		
AEM8038	205	RIC9034	223		
		RIC9035	223		























LAME E INCISORI - SEZIONATRICE

SAW BLADES AND SCORING BLADES - SIZING

LAME E INCISORI - SEZIONATRICE

SAW BLADES AND SCORING BLADES - SIZING

	CUTPLUS 1 LAM1001 - LAM1002 LAMA IN DIAMANTE RAPEZIOIDALE DIA H4 - H6 PCD SAW BLADE H4 - H6	9 PAG.
	TOPCUT 1 LAM1003 - LAM1004 LAMA IN DIAMANTE PER SEZIONATRICE DIA H4 - H6 PCD SAW BLADE FOR PANEL SIZING MACHINE H4 - H6	10 PAG.
	TOPCUT 2 LAM1005 - LAM1006 LAMA INCISORE IN DIAMANTE DIA H4 - H6 PCD CONICAL SCORING BLADE H4 - H6	14 PAG.
	TOPCUT 3 LAM1007 - LAM1008 LAMA INCISORE REGOLABILE IN DIAMANTE DIA H4 PCD ADJUSTABLE SCORING BLADE H4	17 PAG.
	FOLDINGCUT 1 LAM1011 - LAM1012 LAMA IN DIAMANTE PER FOLDING DIA H4 - H6 PCD SAW BLADE FOR FOLDING H4 - H6	18 PAG.
	LAMELLO 1 LAM1009 FRESA LAMELLO PER INCASTRI CLAMEX P-SYSTEM CLAMEX P-SYSTEM PCD BLADE FOR LAMELLO	19 PAG.
	LAMELLO 2 LAM1013 FRESA LAMELLO PER INCASTRI A BISCOTTO LAMELLO SAW BLADE FOR BISCUIT JOINTING SYSTEM	20 PAG.
	MANUALCUT 1 LAM1010 LAMA IN DIAMANTE PER MACCHINE PORTATILI LAVORAZIONE DI MATERIALI DURI E ABRASIVI DIA H4 PCD SAWBLADE FOR HARD AND ABRASIVE MATERIALS	21 PAG.
	CUTPLUS 2 LAM1514 LAMA IN HW PER SQUADRARE LEGNO AD ALTO RENDIMENTO HIGH PERFORMANCE SAW BLADE FOR SQUARING IN HW	22 PAG.
	CUTPLUS 3 LAM1515 LAMA IN HW PER SQUADRARE TRUCIOLARE E MDF HW SAW BLADE FOR SQUAR- ING CHEAPBOARD AND MDF	23 PAG.
	TOPCUT 4 LAM1516 LAMA INCISORE CONICO IN WIIDIA CONICAL SCORING BLADE IN HW	24 PAG.
	TOPCUT 5 LAM1517 LAMA IN HW CON LIMITATORE DI TRUCIOLO HW SAW BLADE WITH CHIP LIMITER	26 PAG.
	TOPCUT 6 LAM1518 LAMA IN HW CON TAGLIENTE CONCAVO HW SAW BLADE WITH HZ TEETH	27 PAG.
	TOPCUT 7 LAM1519 LAMA CIRCOLARE CON RASANTI PER MULTILAMA HW SAW BLADE MULTI RIP	28 PAG.
	TOPCUT 8 LAM1520 LAMA CIRCOLARE IN HW PER SEZIONATARICI HW SAW BLADE FOR CUTTING	30 PAG.
	TOPCUT 9 LAM1521 LAMA INCISORE REGOLABILE IN HW HW ADJUSTABLE SCORING BLADE	32 PAG.
	GROOVINGCUT 1 LAM1522 LAMA CIRCOLARE IN HW PER CANALI HW GROOVING BLADE	33 PAG.
	TOPCUT 10 LAM1523 LAMA CIRCOLARE IN HW CON TAGLIENTI NEGATIVI PER METALLI LEGGERI HW SAW BLADE WITH NEGATIVE CUTTING SUITABLE FOR LIGHT METAL	35 PAG.
	TOPCUT 11 LAM1524 LAMA CIRCOLARE IN HW CON TAGLIENTI POSITIVI PER METALLI LEGGERI HW SAW BLADE WITH POSITIVE CUTTING SUITABLE FOR LIGHT METAL	37 PAG.
	LAMELLO 5 LAM1525 FRESA LAMELLO IN HW PER INCASTRI A BISCOTTO LAMELLO HW SAW BLADE FOR BISCUIT JOINTING SYSTEM	39 PAG.

CUTPLUS 1 LAM1001 - LAM1002



LAMA IN DIAMANTE TRAPEZOIDALE DIA H4 - H6

PCD SAW BLADE H4 - H6

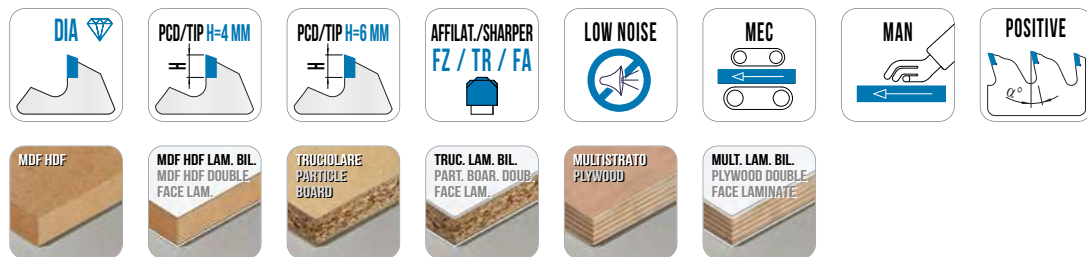

Lama in diamante per seghe circolari a banco e sezionatrici orizzontali. Ideali per la sezionatura di pannelli bilaminati con l'ausilio dell'incisore.

PCD saw blade tips H4 mm to be used on sliding table saw saws and horizontal panel saws. Suitable for cutting bilaminated panels using scoring blade.

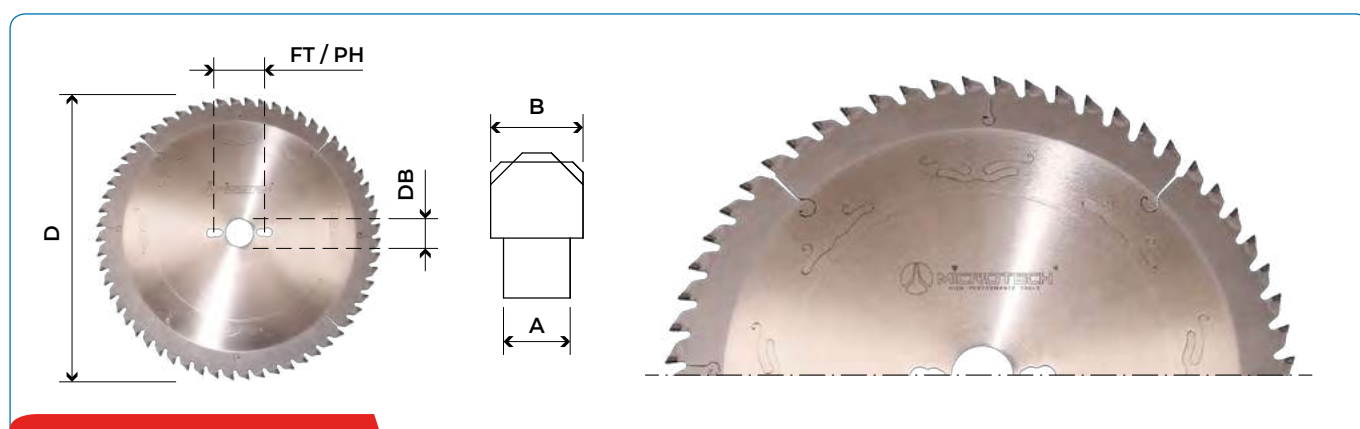

LAM1001 H PCD= 4mm			DIMENSIONI DIMENSIONS				ARTICOLI ITEMS	PREZZI €
D DIAMETER	B THICKNESS	Z TOTAL TEETH	DB HOLE DIAMETER	A THICKNESS	α° CUTTING ANGLE	FT / PH PHIN HOLE	COD / SKU	PRICE €
250	3,2	48	30	2,2	10°	2(7/42)+2(9/46,4)+2(10/60)	LAM1001010	
250	3,2	54	30	2,2	10°	2(7/42)+2(9/46,4)+2(10/60)	LAM1001001	
250	3,2	60	30	2,2	10°	2(7/42)+2(9/46,4)+2(10/60)	LAM1001002	
250	3,2	80	30	2,2	10°	2(7/42)+2(9/46,4)+2(10/60)	LAM1001003	
300	3,2	48	30	2,2	10°	2(7/42)+2(9/46,4)+2(10/60)	LAM1001004	
300	3,2	60	30	2,2	10°	2(7/42)+2(9/46,4)+2(10/60)	LAM1001005	
300	3,2	72	30	2,2	10°	2(7/42)+2(9/46,4)+2(10/60)	LAM1001006	
300	3,2	96	30	2,2	10°	2(7/42)+2(9/46,4)+2(10/60)	LAM1001007	
350	3,5	72	30	2,5	10°	2(7/42)+2(9/46,4)+2(10/60)	LAM1001011	
350	3,5	84	30	2,5	10°	2(7/42)+2(9/46,4)+2(10/60)	LAM1001008	
350	3,5	108	30	2,5	10°	2(7/42)+2(9/46,4)+2(10/60)	LAM1001009	

LAM1002 H PCD= 6mm			DIMENSIONI DIMENSIONS				ARTICOLI ITEMS	PREZZI €
D DIAMETER	B THICKNESS	Z TOTAL TEETH	DB HOLE DIAMETER	A THICKNESS	α° CUTTING ANGLE	FT / PH PHIN HOLE	COD / SKU	PRICE €
250	3,2	48	30	2,2	10°	2(7/42)+2(9/46,4)+2(10/60)	LAM1002010	
250	3,2	54	30	2,2	10°	2(7/42)+2(9/46,4)+2(10/60)	LAM1002001	
250	3,2	60	30	2,2	10°	2(7/42)+2(9/46,4)+2(10/60)	LAM1002002	
250	3,2	80	30	2,2	10°	2(7/42)+2(9/46,4)+2(10/60)	LAM1002003	
300	3,2	48	30	2,2	10°	2(7/42)+2(9/46,4)+2(10/60)	LAM1002004	
300	3,2	60	30	2,2	10°	2(7/42)+2(9/46,4)+2(10/60)	LAM1002005	
300	3,2	72	30	2,2	10°	2(7/42)+2(9/46,4)+2(10/60)	LAM1002006	
300	3,2	96	30	2,2	10°	2(7/42)+2(9/46,4)+2(10/60)	LAM1002007	
350	3,5	72	30	2,5	10°	2(7/42)+2(9/46,4)+2(10/60)	LAM1002011	
350	3,5	84	30	2,5	10°	2(7/42)+2(9/46,4)+2(10/60)	LAM1002008	
350	3,5	108	30	2,5	10°	2(7/42)+2(9/46,4)+2(10/60)	LAM1002009	

TOPCUT 1 LAM1003 - LAM1004



LAMA IN DIAMANTE SEZIONATRICE DIA H4 - H6

PCD SAW BLADE FOR PANEL SIZING MACHINE H4 - H6

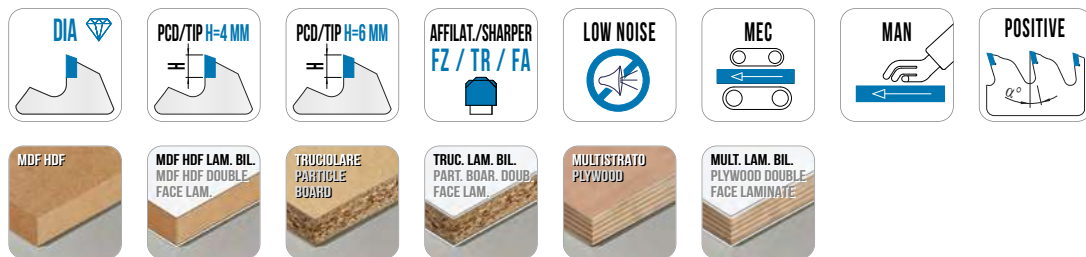

Lama in diamante per la sezionatura di pannelli singoli o a pacco con l'ausilio dell'incisore.

PCD saw blade for panel sizing machine tips H4/H6 mm Suitable to cut from single panel to panels stack using also scoring blade.

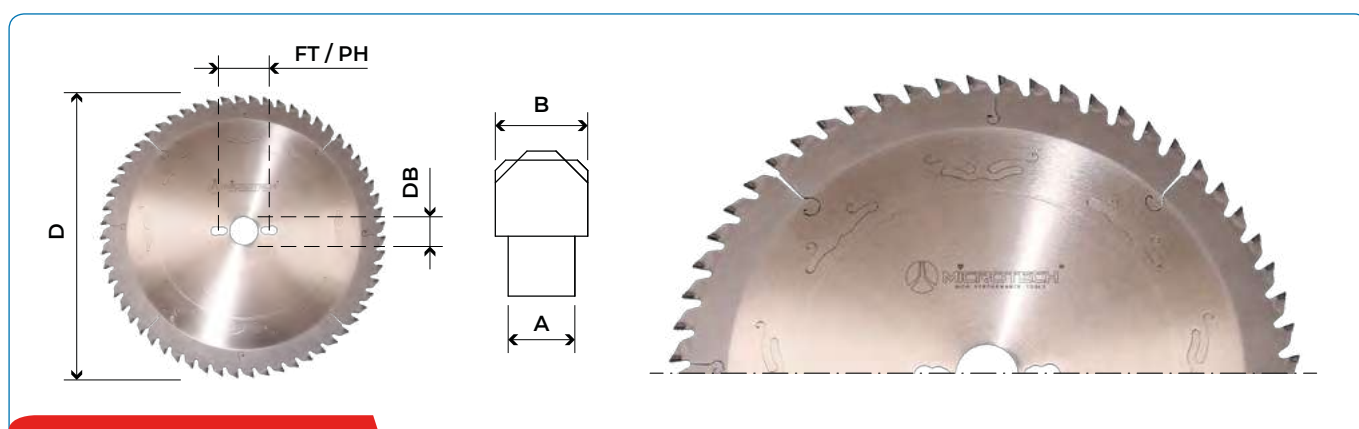

LAM1003 H PCD= 4mm

DIMENSIONI		DIMENSIONS		TIPO DI MACCHINA		ARTICOLI ITEMS		PREZZI €	
D	B	Z	DB	A	α °	FT / PH	MACHINE TYPES	COD / SKU	PRICE €
DIAMETER	THICKNESS	TOTAL TEETH	HOLE DIAMETER	THICKNESS	CUTTING ANGLE	PHIN HOLE			
300	4,4	60	30	3	10°	2(10/60)	PANHANS	LAM1003001	
300	4,4	60	65	3	10°	2(9/110)	SELCO	LAM1003002	
300	4,4	60	75	3	10°	NON PRESENTI	HOMAG	LAM1003003	
300	4,4	60	80	3	10°	2(14/110)+4(9/100)	SCM	LAM1003004	
300	4,4	72	30	3	10°	2(10/60)	PANHANS	LAM1003005	
300	4,4	72	65	3	10°	2(9/110)	SELCO	LAM1003006	
300	4,4	72	75	3	10°	NON PRESENTI	HOMAG	LAM1003007	
300	4,4	72	80	3	10°	2(14/110)+4(9/100)	SCM	LAM1003008	
305	4,4	60	60	3	10°	2(10/60)	MAYER, PANHANS, SCM	LAM1003009	
320	4,4	72	65	3,2	10°	2(9/110)	SELCO	LAM1003010	
320	4,4	72	75	3,2	10°	3/13/95	GIBEN	LAM1003011	
350	4,4	54	30	3,2	10°	2(10/60)	PANHANS, SCHEER	LAM1003012	
350	4,4	54	60	3,2	10°	2(14/100)	HOLZMA	LAM1003013	
350	4,4	72	30	3,2	10°	2(10/60)	PAHANS, SCHEER	LAM1003014	
350	4,4	72	50	3,2	10°	4(13/80)	GIBEN	LAM1003015	
350	4,4	72	60	3,2	10°	2(14/100)	HOLZMA	LAM1003016	
350	4,4	72	80	3,2	10°	4(9/100)+2(9/110)+2(14/110)	GABBIANI	LAM1003017	
355	4,4	54	30	3,2	10°	2(10/60)	PANHANS, SCM	LAM1003018	
355	4,4	54	75	3,2	10°	NON PRESENTI	GIBEN	LAM1003019	
355	4,4	54	80	3,2	10°	4(9/100)+2(9/110)+2(14/110)	GABBIANI	LAM1003020	
355	4,4	72	30	3,2	10°	2(10/60)	PANHANS, SCM	LAM1003021	
355	4,4	72	75	3,2	10°	NON PRESENTI	GIBEN	LAM1003022	
355	4,4	72	80	3,2	10°	4(9/100)+2(9/110)+2(14/110)	GABBIANI	LAM1003023	
360	4,4	60	65	3	10°	2(9/110)	SELCO	LAM1003024	
360	4,4	72	65	3,2	10°	2(9/110)	SELCO	LAM1003025	
380	4,4	48	50	3	10°	4(13/80)	GIBEN	LAM1003026	
380	4,4	48	80	3	10°	4(9/100)+2(9/110)+2(14/110)	GABBIANI	LAM1003027	
380	4,4	60	50	3	10°	4(13/80)	GIBEN	LAM1003028	
380	4,4	60	60	3,2	10°	2(14/100)	HOLZMA	LAM1003029	
380	4,4	72	30	3,2	10°	2(8/83)	NON PRESENTI	LAM1003030	
380	4,4	72	50	3,2	10°	4(13/80)	GIBEN	LAM1003031	



LAM1003 H PCD= 4mm

DIMENSIONI				DIMENSIONS			TIPO DI MACCHINA	ARTICOLI ITEMS	PREZZI €
D	B	Z	DB	A	α °	FT / PH	MACHINE TYPES	COD / SKU	PRICE €
DIAMETER	THICKNESS	TOTAL TEETH	HOLE DIAMETER	THICKNESS	CUTTING ANGLE	PHIN HOLE			
380	4,4	72	60	3,2	10°	2(14/100)	HOLZMA	LAM1003032	
380	4,4	72	80	3,2	10°	4(9/100)+2(9/110)+2(14/110)	GABBIANI	LAM1003033	
380	4,8	60	60	3,5	10°	2(14/100)	HOLZMA	LAM1003034	
380	4,8	72	60	3,5	10°	2(14/100)	HOLZMA	LAM1003035	
380	4,8	84	60	3,5	10°	2(14/100)	HOLZMA	LAM1003036	
400	4,4	48	30	3	10°	NON PRESENTI	NON PRESENTI	LAM1003037	
400	4,4	48	75	3	10°	4(15/105)	GIBEN	LAM1003038	
400	4,4	48	80	3	10°	4(19/120)+2(9/130)	SELCO	LAM1003039	
400	4,4	48	80	3	10°	4(9/100)+2(9/110)+2(14/110)	GABBIANI	LAM1003040	
400	4,4	60	30	3,2	10°	2(10/60)	NON PRESENTI	LAM1003041	
400	4,4	60	75	3,2	10°	4(15/105)	GIBEN	LAM1003042	
400	4,4	60	80	3,2	10°	4(19/120)+2(9/130)	SELCO	LAM1003043	
400	4,4	60	80	3,2	10°	4(9/100)+2(9/110)+2(14/110)	GABBIANI	LAM1003044	
400	4,4	72	30	3,2	10°	2(10/60)	SCHEER	LAM1003045	
400	4,4	72	75	3,2	10°	4(15/105)	GIBEN	LAM1003046	
400	4,4	72	80	3,2	10°	4(19/120)+2(9/130)	SELCO	LAM1003047	
400	4,4	72	80	3,2	10°	4(9/100)+2(9/110)+2(14/110)	GABBIANI	LAM1003048	
400	4,8	72	60	3,5	10°	NON PRESENTI	HOLZMA	LAM1003049	
420	4,8	60	60	3,5	10°	2(14/125)	HOLZMA	LAM1003050	
420	4,8	84	60	3,5	10°	3(14/76)	HOLZMA	LAM1003051	
430	4,4	48	30	3	10°	NON PRESENTI	HOLZMA	LAM1003052	
430	4,4	48	75	3,2	10°	4(15/105)	GIBEN	LAM1003053	
430	4,4	48	80	3	10°	2(9/130)+4(19/120)+2(14/110)	SELCO + GABBIANI	LAM1003054	
430	4,4	60	30	3	10°	2(10/60)	NON PRESENTI	LAM1003055	
430	4,4	60	75	3,2	10°	4(15/105)	GIBEN	LAM1003056	
430	4,4	60	80	3,2	10°	2(9/130)+4(19/120)+2(14/110)	SELCO + GABBIANI	LAM1003057	
430	4,4	72	30	3,2	10°	NON PRESENTI		LAM1003058	
430	4,4	72	75	3,2	10°	4(15/105)	GIBEN	LAM1003059	
430	4,4	72	80	3,2	10°	2(9/130)+4(19/120)+2(14/110)	SELCO + GABBIANI	LAM1003060	
430	4,4	96	75	3,2	10°	4(15/105)	GIBEN + PRISMATIC	LAM1003061	
450	4,4	48	30	3	10°	2(9/60)	MAYER, PANHANS, SCHELLING	LAM1003062	
450	4,4	48	60	3	10°	2(14/125)	HOLZMA	LAM1003063	
450	4,4	48	80	3	10°	2(9/130)+4(19/120)+2(14/110)	SELCO + GABBIANI	LAM1003064	
450	4,4	60	30	3	10°	2(10/60)	MAYER, PANHANS, SCHELLING	LAM1003065	
450	4,4	60	60	3,2	10°	2(14/125)	HOLZMA	LAM1003066	
450	4,4	60	80	3,2	10°	2(9/130)+4(19/120)+2(14/110)	SELCO + GABBIANI	LAM1003067	
450	4,4	72	30	3,2	10°	2(10/60)	MAYER, PANHANS, SCHELLING	LAM1003068	
450	4,4	72	60	3,2	10°	2(14/125)	HOLZMA	LAM1003069	
450	4,4	72	80	3,2	10°	2(9/130)+4(19/120)+2(14/110)	SELCO + GABBIANI	LAM1003070	
450	4,8	48	30	3,5	10°	2(9/60)	MAYER, PANHANS, SCHELLING	LAM1003071	
450	4,8	48	60	3,5	10°	2(14/125)	HOLZMA	LAM1003072	
450	4,8	48	80	3,5	10°	2(9/130)+4(19/120)	SELCO	LAM1003073	
450	4,8	60	30	3,5	10°	2(9/60)	SCHEER	LAM1003074	
450	4,8	60	60	3,5	10°	2(14/125)	HOLZMA	LAM1003075	
450	4,8	60	80	3,5	10°	2(9/130)+4(19/120)	SELCO	LAM1003076	
450	4,8	72	30	3,5	10°	2(9/60)	SCHEER	LAM1003077	
450	4,8	72	60	3,5	10°	2(14/125)+2(17/100)	HOLZMA	LAM1003078	
450	4,8	72	80	3,5	10°	2(9/130)+4(19/130)	SELCO	LAM1003079	
460	4,4	72	30	3,5	10°	2(13/94)	SCHELLING	LAM1003080	
470	4,4	48	75	3,2	10°	4(15/105)	GIBEN	LAM1003081	
470	4,4	60	75	3,2	10°	4(15/105)	GIBEN	LAM1003082	
470	4,4	72	75	3,2	10°	4(15/105)	GIBEN	LAM1003083	
470	4,4	96	75	3,2	10°	4(15/105)	GIBEN	LAM1003084	
480	4,8	48	80	3,5	10°	2(9/130)+4(19/120)	SELCO	LAM1003085	
480	4,8	60	80	3,5	10°	2(9/130)+4(19/120)	SELCO	LAM1003086	
480	4,8	72	30	3,5	10°	2(10/60)	SCHELLING	LAM1003087	
480	4,8	72	80	3,5	10°	2(9/130)+4(19/120)	SELCO	LAM1003088	
500	4,4	48	30	3,2	10°	NON PRESENTI	SCHELLING	LAM1003089	
500	4,4	48	80	3,2	10°	4(9/100)+2(9/110)+2(14/110)	GABBIANI	LAM1003090	
500	4,4	60	30	3,2	10°	NON PRESENTI	SCHELLING	LAM1003091	
500	4,4	60	80	3,2	10°	4(9/100)+2(9/110)+2(14/110)	GABBIANI	LAM1003092	
500	4,4	72	30	3,2	10°	NON PRESENTI	SCHELLING	LAM1003093	
500	4,8	48	30	3,5	10°	NON PRESENTI	SCHELLING	LAM1003094	
500	4,8	48	60	3,5	10°	2(11/115)	HOLZMA	LAM1003095	
500	4,8	48	75	3,5	10°	4(15/105)	GIBEN	LAM1003096	
500	4,8	60	60	3,5	10°	2(11/115)	HOLZMA	LAM1003097	
500	4,8	60	75	3,5	10°	4(15/105)	GIBEN	LAM1003098	
500	4,8	72	60	3,5	10°	2(11/115)	HOLZMA	LAM1003099	
500	4,8	72	75	3,5	10°	4(15/105)	GIBEN	LAM1003100	
520	4,8	48	60	3,5	10°	2(19/120)+2(11/115)	HOLZMA	LAM1003101	
520	4,8	60	60	3,5	11°	2(19/120)+2(11/115)	HOLZMA	LAM1003102	
520	4,8	72	60	3,5	12°	2(19/120)+2(11/115)	HOLZMA	LAM1003103	

LAME E INCISORI - SEZIONATRICE
SAW BLADES AND SCORING BLADES - SIZING
LAM

LAM1004 H PCD= 6mm

D		B	Z	DB	DIMENSIONI DIMENSIONS		FT / PH		TIPO DI MACCHINA	ARTICOLI ITEMS	PREZZI €
DIAMETER	THICKNESS	TOTAL TEETH	HOLE	DIAMETER	A	α °	CUTTING ANGLE	PHIN HOLE	MACHINE TYPES	COD / SKU	PRICE €
300	4,4	60		30	3	10°		2(10/60)	PANHANS	LAM1004001	
300	4,4	60		65	3	10°		2(9/110)	SELCO	LAM1004002	
300	4,4	60		75	3	10°		NON PRESENTI	HOMAG	LAM1004003	
300	4,4	60		80	3	10°		2(14/110)+4(9/100)	SCM	LAM1004004	
300	4,4	72		30	3	10°		2(10/60)	PANHANS	LAM1004005	
300	4,4	72		65	3	10°		2(9/110)	SELCO	LAM1004006	
300	4,4	72		75	3	10°		NON PRESENTI	HOMAG	LAM1004007	
300	4,4	72		80	3	10°		2(14/110)+4(9/100)	SCM	LAM1004008	
305	4,4	60		60	3	10°		2(10/60)	MAYER, PANHANS, SCHELLING	LAM1004009	
320	4,4	72		65	3,2	10°		2(9/110)	SELCO	LAM1004010	
320	4,4	72		75	3,2	10°		3/13/95	GIBEN	LAM1004011	
350	4,4	54		30	3,2	10°		2(10/60)	PANHANS, SCHEER	LAM1004012	
350	4,4	54		60	3,2	10°		2(14/100)	HOLZMA	LAM1004013	
350	4,4	72		30	3,2	10°		2(10/60)	PAHANS, SCHEER	LAM1004014	
350	4,4	72		50	3,2	10°		4(13/80)	GIBEN	LAM1004015	
350	4,4	72		60	3,2	10°		2(14/100)	HOLZMA	LAM1004016	
350	4,4	72		80	3,2	10°		4(9/100)+2(9/110)+2(14/110)	GABBIANI	LAM1004017	
355	4,4	54		30	3,2	10°		2(10/60)	PANHANS, SCM	LAM1004018	
355	4,4	54		75	3,2	10°		NON PRESENTI	GIBEN	LAM1004019	
355	4,4	54		80	3,2	10°		4(9/100)+2(9/110)+2(14/110)	GABBIANI	LAM1004020	
355	4,4	72		30	3,2	10°		2(10/60)	PANHANS, SCM	LAM1004021	
355	4,4	72		75	3,2	10°		NON PRESENTI	GIBEN	LAM1004022	
355	4,4	72		80	3,2	10°		4(9/100)+2(9/110)+2(14/110)	GABBIANI	LAM1004023	
360	4,4	60		65	3	10°		2(9/110)	SELCO	LAM1004024	
360	4,4	72		65	3,2	10°		2(9/110)	SELCO	LAM1004025	
380	4,4	48		50	3	10°		4(13/80)	GIBEN	LAM1004026	
380	4,4	48		80	3	10°		4(9/100)+2(9/110)+2(14/110)	GABBIANI	LAM1004027	
380	4,4	60		50	3	10°		4(13/80)	GIBEN	LAM1004028	
380	4,4	60		60	3,2	10°		2(14/100)	HOLZMA	LAM1004029	
380	4,4	72		30	3,2	10°		2(8/83)	NON PRESENTI	LAM1004030	
380	4,4	72		50	3,2	10°		4(13/80)	GIBEN	LAM1004031	
380	4,4	72		60	3,2	10°		2(14/100)	HOLZMA	LAM1004032	
380	4,4	72		80	3,2	10°		4(9/100)+2(9/110)+2(14/110)	GABBIANI	LAM1004033	
380	4,8	60		60	3,5	10°		2(14/100)	HOLZMA	LAM1004034	
380	4,8	72		60	3,5	10°		2(14/100)	HOLZMA	LAM1004035	
380	4,8	84		60	3,5	10°		2(14/100)	HOLZMA	LAM1004036	
400	4,4	48		30	3	10°		NON PRESENTI	NON PRESENTI	LAM1004037	
400	4,4	48		75	3	10°		4(15/105)	GIBEN	LAM1004038	
400	4,4	48		80	3	10°		4(19/120)+2(9/130)	SELCO	LAM1004039	
400	4,4	48		80	3	10°		4(9/100)+2(9/110)+2(14/110)	GABBIANI	LAM1004040	
400	4,4	60		30	3,2	10°		2(10/60)	NON PRESENTI	LAM1004041	
400	4,4	60		75	3,2	10°		4(15/105)	GIBEN	LAM1004042	
400	4,4	60		80	3,2	10°		4(19/120)+2(9/130)	SELCO	LAM1004043	
400	4,4	60		80	3,2	10°		4(9/100)+2(9/110)+2(14/110)	GABBIANI	LAM1004044	
400	4,4	72		30	3,2	10°		2(10/60)	SCHEER	LAM1004045	
400	4,4	72		75	3,2	10°		4(15/105)	GIBEN	LAM1004046	
400	4,4	72		80	3,2	10°		4(19/120)+2(9/130)	SELCO	LAM1004047	
400	4,4	72		80	3,2	10°		4(9/100)+2(9/110)+2(14/110)	GABBIANI	LAM1004048	
400	4,8	72		60	3,5	10°		NON PRESENTI	HOLZMA	LAM1004049	
420	4,8	60		60	3,5	10°		2(14/125)	HOLZMA	LAM1004050	
420	4,8	84		60	3,5	10°		3(14/76)	HOLZMA	LAM1004051	
430	4,4	48		30	3	10°		NON PRESENTI	HOLZMA	LAM1004052	
430	4,4	48		75	3,2	10°		4(15/105)	GIBEN	LAM1004053	
430	4,4	48		80	3	10°		2(9/130)+4(19/120)+2(14/110)	SELCO + GABBIANI	LAM1004054	
430	4,4	60		30	3	10°		2(10/60)	NON PRESENTI	LAM1004055	
430	4,4	60		75	3,2	10°		4(15/105)	GIBEN	LAM1004056	
430	4,4	60		80	3,2	10°		2(9/130)+4(19/120)+2(14/110)	SELCO + GABBIANI	LAM1004057	
430	4,4	72		30	3,2	10°		NON PRESENTI		LAM1004058	
430	4,4	72		75	3,2	10°		4(15/105)	GIBEN	LAM1004059	
430	4,4	72		80	3,2	10°		2(9/130)+4(19/120)+2(14/110)	SELCO + GABBIANI	LAM1004060	
430	4,4	96		75	3,2	10°		4(15/105)	GIBEN + PRISMATIC	LAM1004061	
450	4,4	48		30	3	10°		2(9/60)	MAYER, PANHANS, SCHELLING	LAM1004062	
450	4,4	48		60	3	10°		2(14/125)	HOLZMA	LAM1004063	
450	4,4	48		80	3	10°		2(9/130)+4(19/120)+2(14/110)	SELCO + GABBIANI	LAM1004064	
450	4,4	60		30	3	10°		2(10/60)	MAYER, PANHANS, SCHELLING	LAM1004065	
450	4,4	60		60	3,2	10°		2(14/125)	HOLZMA	LAM1004066	
450	4,4	60		80	3,2	10°		2(9/130)+4(19/120)+2(14/110)	SELCO + GABBIANI	LAM1004067	
450	4,4	72		30	3,2	10°		2(10/60)	MAYER, PANHANS, SCHELLING	LAM1004068	
450	4,4	72		60	3,2	10°		2(14/125)	HOLZMA	LAM1004069	
450	4,4	72		80	3,2	10°		2(9/130)+4(19/120)+2(14/110)	SELCO + GABBIANI	LAM1004070	
450	4,8	48		30	3,5	10°		2(9/60)	MAYER, PANHANS, SCHELLING	LAM1004071	
450	4,8	48		60	3,5	10°		2(14/125)	HOLZMA	LAM1004072	



LAM1004 H PCD= 6mm

DIMENSIONI		DIMENSIONS		TIPO DI MACCHINA		ARTICOLI ITEMS		PREZZI €	
D	B	Z	DB	A	α °	FT / PH	MACHINE TYPES	COD / SKU	PRICE €
DIAMETER	THICKNESS	TOTAL TEETH	HOLE DIAMETER	THICKNESS	CUTTING ANGLE	PHIN HOLE			
450	4,8	48	80	3.5	10°	2(9/130)+4(19/120)	SELCO	LAM1004073	
450	4,8	60	30	3.5	10°	2(9/60)	SCHEER	LAM1004074	
450	4,8	60	60	3.5	10°	2(14/1259)	HOLZMA	LAM1004075	
450	4,8	60	80	3.5	10°	2(9/130)+4(19/120)	SELCO	LAM1004076	
450	4,8	72	30	3.5	10°	2(9/60)	SCHEER	LAM1004077	
450	4,8	72	60	3.5	10°	2(14/125)+2(17/100)	HOLZMA	LAM1004078	
450	4,8	72	80	3.5	10°	2(9/130)+4(19/130)	SELCO	LAM1004079	
460	4,4	72	30	3.5	10°	2(13/94)	SCHELLING	LAM1004080	
470	4,4	48	75	3.2	10°	4(15/105)	GIBEN	LAM1004081	
470	4,4	60	75	3.2	10°	4(15/105)	GIBEN	LAM1004082	
470	4,4	72	75	3.2	10°	4(15/105)	GIBEN	LAM1004083	
470	4,4	96	75	3.2	10°	4(15/105)	GIBEN	LAM1004084	
480	4,8	48	80	3.5	10°	2(9/130)+4(19/120)	SELCO	LAM1004085	
480	4,8	60	80	3.5	10°	2(9/130)+4(19/120)	SELCO	LAM1004086	
480	4,8	72	30	3.5	10°	2(10/60)	SCHELLING	LAM1004087	
480	4,8	72	80	3.5	10°	2(9/130)+4(19/120)	SELCO	LAM1004088	
500	4,4	48	30	3.2	10°	NON PRESENTI	SCHELLING	LAM1004089	
500	4,4	48	80	3.2	10°	4(9/100)+2(9/110)+2(14/110)	GABBIANI	LAM1004090	
500	4,4	60	30	3.2	10°	NON PRESENTI	SCHELLING	LAM1004091	
500	4,4	60	80	3.2	10°	4(9/100)+2(9/110)+2(14/110)	GABBIANI	LAM1004092	
500	4,4	72	30	3.2	10°	NON PRESENTI	SCHELLING	LAM1004093	
500	4,8	48	30	3.5	10°	NON PRESENTI	SCHELLING	LAM1004094	
500	4,8	48	60	3.5	10°	2(11/115)	HOLZMA	LAM1004095	
500	4,8	48	75	3.5	10°	4(15/105)	GIBEN	LAM1004096	
500	4,8	60	60	3.5	10°	2(11/115)	HOLZMA	LAM1004097	
500	4,8	60	75	3.5	10°	4(15/105)	GIBEN	LAM1004098	
500	4,8	72	60	3.5	10°	2(11/115)	HOLZMA	LAM1004099	
500	4,8	72	75	3.5	10°	4(15/105)	GIBEN	LAM1004100	
520	4,8	48	60	3.5	10°	2(19/120)+2(11/115)	HOLZMA	LAM1004101	
520	4,8	60	60	3.5	11°	2(19/120)+2(11/115)	HOLZMA	LAM1004102	
520	4,8	72	60	3.5	12°	2(19/120)+2(11/115)	HOLZMA	LAM1004103	

TOPCUT 2 LAM1005 - LAM1006



LAMA INCISORE IN DIAMANTE DIA H4 - H6

PCD CONICAL SCORING BLADE H4 - H6

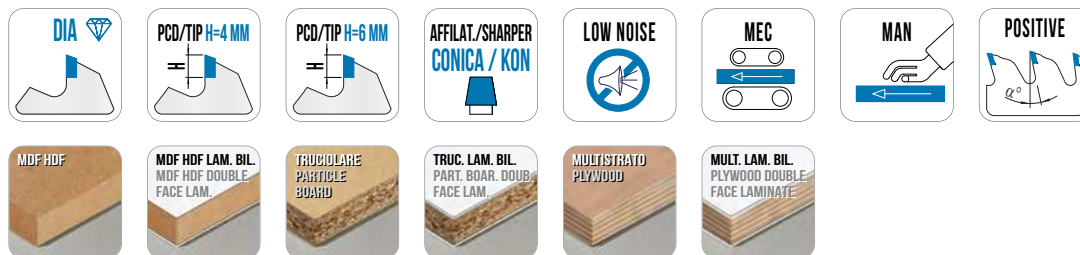

Incisore in diamante per l'incisione di pannelli bilaminati. Applicabile su macchine sezionatrici orizzontali con l'albero dell'incisore regolabile in altezza in funzione dello spessore di taglio della lama sezionatrice.

PCD conical scoring blade for engraving in bilaminated panels tips H4/H6 mm.

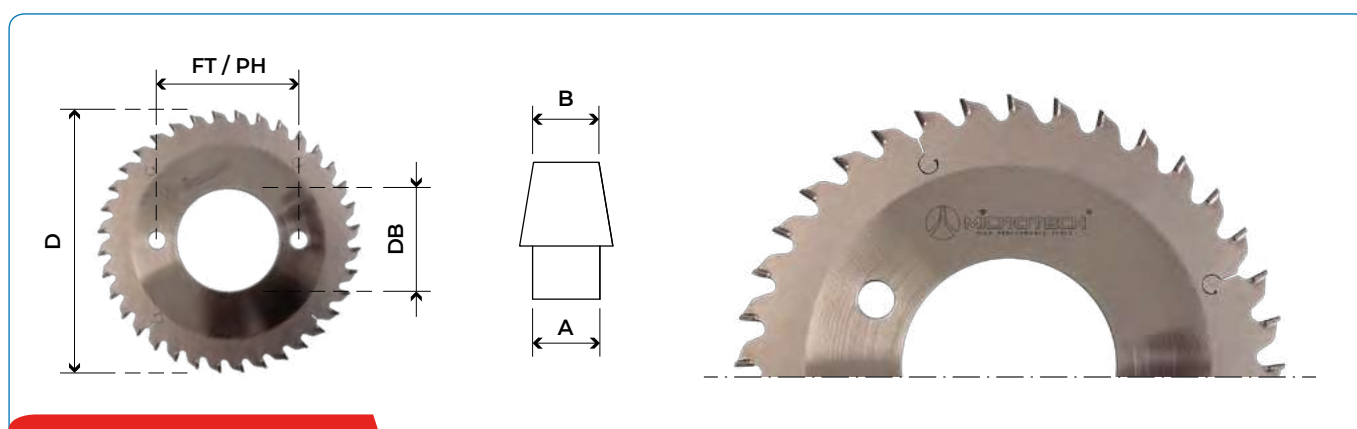

LAM1005 H PCD= 4mm			DIMENSIONI DIMENSIONS				TIPO DI MACCHINA	ARTICOLI ITEMS	PREZZI €
D	B	Z	DB	A	α°	FT / PH	MACHINE TYPES	COD / SKU	PRICE €
DIAMETER	THICKNESS	TOTAL TEETH	HOLE DIAMETER	THICKNESS	CUTTING ANGLE	PHIN HOLE			
80	3.1/4.3	12	20	2,2	5°			LAM1005001	
80	3.1/4.3	12	22	2,2	5°			LAM1005002	
100	3.1/4.3	24	20	2,2	5°		SCHELLING	LAM1005003	
100	3.1/4.3	24	22	2,2	5°			LAM1005004	
110	3.1/4.3	24	20	2,2	5°			LAM1005005	
110	3.1/4.3	24	22	2,2	5°			LAM1005006	
115	3.1/4.3	24	20	2,2	5°			LAM1005007	
115	3.1/4.3	24	22	2,2	5°			LAM1005008	
120	2.8/4	24	20	2,2	5°		SCHELLING	LAM1005009	
120	2.8/4	24	22	2,2	5°			LAM1005010	
120	3.1/4.3	24	20	2,2	5°			LAM1005011	
120	3.1/4.3	24	22	2,2	5°			LAM1005012	
120	3.4/4.6	24	20	2,2	5°			LAM1005013	
125	3.1/4.3	24	20	2,2	5°		PANHANS 693 EURO 5	LAM1005014	
125	3.1/4.3	24	22	2,2	5°		MARTIN	LAM1005015	
125	3.4/4.6	24	20	2,2	5°			LAM1005016	
125	3.4/4.6	24	20	2,2	5°		PANHANS 693 EURO 5	LAM1005018	
125	3.4/4.6	24	45	2,2	5°		GIBEN - HOMAG	LAM1005021	
140	3.4/4.6	28	16	2,2	5°	1(6/33)	SCHEER FM	LAM1005022	
140	3.4/4.6	28	45	2,2	5°		EUROMAC	LAM1005024	
140	3.4/4.6	24	45	2,2	5°			LAM1005025	
150	3.4/4.6	36	30	2,2	5°		SCM	LAM1005028	
150	3.4/4.6	36	45	2,2	5°		SCM	LAM1005031	
160	3.4/4.6	36	20	2,2	7°		LANGZAUNER	LAM1005032	
160	3.4/4.6	36	25,4	2,2	7°			LAM1005033	
160	3.4/4.6	36	30	2,2	7°		LANGZAUNER	LAM1005034	
160	3.4/4.6	36	55	2,2	7°	3(7/66)+3(6/84)	GABBIANI	LAM1005036	
160	3.4/4.6	36	60	2,2	7°	3(7/80)		LAM1005037	
160	3.4/4.6	36	45	2,2	7°	3(11/70)	GIBEN	LAM1005038	
160	3.4/4.6	36	55	2,2	7°	3(7/66)+3(9/72)	GABBIANI	LAM1005039	
160	3.4/4.6	36	60	2,2	7°	3(7/80)		LAM1005040	



LAM1005 H PCD= 4mm

DIMENSIONI		DIMENSIONS		TIPO DI MACCHINA		ARTICOLI ITEMS		PREZZI €	
D	B	Z	DB	A	α °	FT / PH	MACHINE TYPES	COD / SKU	PRICE €
DIAMETER	THICKNESS	TOTAL TEETH	HOLE DIAMETER	THICKNESS	CUTTING ANGLE	PHIN HOLE			
180	3.4/4.6	42	16	2.2	7°	1(6/33)	SCHEER FM	LAM1005041	
180	3.4/4.6	36	25,4	2.2	7°			LAM1005042	
180	4.3/5.5	28	20	3.2	7°		SCHELLING - ANTHON	LAM1005043	
180	4.3/5.5	28	30	3.2	7°	2(7/42)+2(10/60)	PANHANS 693	LAM1005044	
180	4.3/5.5	36	45	3.2	7°		HOLZMA	LAM1005045	
180	4.3/5.5	36	50	3.2	7°	3(13/80)	GIBEN	LAM1005046	
180	4.3/5.5	36	20	3.2	7°		SCHELLING - ANTHON	LAM1005047	
180	4.3/5.5	36	55	3.2	7°	3(7/66)	GABBIANI	LAM1005049	
180	4.3/5.5	36	20	3.2	7°		HOLZMA	LAM1005050	
180	4.3/5.5	36	20	3.2	7°		ANTHON LNC	LAM1005051	
200	4.3/5.5	36	45	3.2	7°		HOLZMA	LAM1005055	
200	4.3/5.5	36	50	3.2	7°	3(13/80)	GIBEN SMART	LAM1005056	
200	4.3/5.5	36	65	3.2	7°	2(9/100)+2(9/110)	SELCO	LAM1005057	
200	4.3/5.5	36	80	3.2	7°	2(14/110)	GABBIANI	LAM1005058	
200	4.3/5.5	36	22	3.2	7°			LAM1005059	
200	4.3/5.5	36	65	3.2	7°	2(8,5/110)	SELCO	LAM1005060	
200	4.3/5.5	36	20	3.2	7°			LAM1005061	
200	4.3/5.5	36	30	3.2	7°	2(9/60)	SCHEER	LAM1005063	
200	4.3/5.5	36	65	3.2	7°	2(9/100)+2(9/110)	SELCO	LAM1005065	
200	4.3/5.5	36	20	3.2	7°		SCHELLING	LAM1005066	
200	4.3/5.5	36	20	3.2	7°		SCHELLING	LAM1005069	
215	4.3/5.5	42	50	3.2	7°	2(7/80)	GIBEN	LAM1005071	
215	4.3/5.5	42	50	3.2	7°	3(15/80)	GIBEN	LAM1005072	
220	4.3/5.5	36	20	3.2	7°		SCHELLING	LAM1005073	
300	4.3/5.5	48	50	3.2	7°	3(15/80)	GIBEN	LAM1005074	
300	4.3/5.5	72	65	3.2	7°	2(9/110)	SELCO	LAM1005075	
300	4.3/5.5	72	80	3.2	7°	2(14/110)		LAM1005076	
320	4.3/5.5	48	45	3.2	7°			LAM1005077	
320	4.3/5.5	48	50	3.2	7°	3(15/80)		LAM1005079	
340	4.7/5.9	72	45	3.5	7°	3(14/65)	HOLZMA	LAM1005080	

LAM1006 H PCD= 6mm

DIMENSIONI		DIMENSIONS		TIPO DI MACCHINA		ARTICOLI ITEMS		PREZZI €	
D	B	Z	DB	A	α °	FT / PH	MACHINE TYPES	COD / SKU	PRICE €
DIAMETER	THICKNESS	TOTAL TEETH	HOLE DIAMETER	THICKNESS	CUTTING ANGLE	PHIN HOLE			
80	3.1/4.3	12	20	2,2	5°			LAM1006001	
80	3.1/4.3	12	22	2,2	5°			LAM1006002	
100	3.1/4.3	24	20	2,2	5°		SCHELLING	LAM1006003	
100	3.1/4.3	24	22	2,2	5°			LAM1006004	
110	3.1/4.3	24	20	2,2	5°			LAM1006005	
110	3.1/4.3	24	22	2,2	5°			LAM1006006	
115	3.1/4.3	24	20	2,2	5°			LAM1006007	
115	3.1/4.3	24	22	2,2	5°			LAM1006008	
120	2.8/4	24	20	2,2	5°		SCHELLING	LAM1006009	
120	2.8/4	24	22	2,2	5°			LAM1006010	
120	3.1/4.3	24	20	2,2	5°			LAM1006011	
120	3.1/4.3	24	22	2,2	5°			LAM1006012	
120	3.4/4.6	24	20	2,2	5°			LAM1006013	
125	3.1/4.3	24	20	2,2	5°		PANHANS 693 EURO 5	LAM1006014	
125	3.1/4.3	24	22	2,2	5°		MARTIN	LAM1006015	
125	3.4/4.6	24	20	2,2	5°			LAM1006016	
125	3.4/4.6	24	20	2,2	5°		PANHANS 693 EURO 5	LAM1006018	
125	3.4/4.6	24	45	2,2	5°		GIBEN - HOMAG	LAM1006021	
140	3.4/4.6	28	16	2,2	5°	1(6/33)	SCHEER FM	LAM1006022	
140	3.4/4.6	28	45	2,2	5°		EUROMAC	LAM1006024	
140	3.4/4.6	24	45	2,2	5°			LAM1006025	
150	3.4/4.6	36	30	2,2	5°		SCM	LAM1006028	
150	3.4/4.6	36	45	2,2	5°		SCM	LAM1006031	
160	3.4/4.6	36	20	2,2	7°		LANGZAUNER	LAM1006032	
160	3.4/4.6	36	25,4	2,2	7°			LAM1006033	
160	3.4/4.6	36	30	2,2	7°		LANGZAUNER	LAM1006034	
160	3.4/4.6	36	55	2,2	7°	3(7/66)+3(6/84)	GABBIANI	LAM1006036	
160	3.4/4.6	36	60	2,2	7°	3(7/80)		LAM1006037	
160	3.4/4.6	36	45	2,2	7°	3(11/70)	GIBEN	LAM1006038	
160	3.4/4.6	36	55	2,2	7°	3(7/66)+3(9/72)	GABBIANI	LAM1006039	
160	3.4/4.6	36	60	2,2	7°	3(7/80)		LAM1006040	
180	3.4/4.6	42	16	2,2	7°	1(6/33)	SCHEER FM	LAM1006041	



LAM1006 H PCD= 6mm

DIMENSIONI		DIMENSIONS		TIPO DI MACCHINA		ARTICOLI ITEMS		PREZZI €	
D	B	Z	DB	A	α °	FT / PH	MACHINE TYPES	COD / SKU	PRICE €
DIAMETER	THICKNESS	TOTAL TEETH	HOLE DIAMETER	THICKNESS	CUTTING ANGLE	PHIN HOLE			
180	3.4/4.6	36	25,4	2.2	7°			LAM1006042	
180	4.3/5.5	28	20	3.2	7°		SCHELLING - ANTHON	LAM1006043	
180	4.3/5.5	28	30	3.2	7°	2(7/42)+2(10/60)	PANHANS 693	LAM1006044	
180	4.3/5.5	36	45	3.2	7°		HOLZMA	LAM1006045	
180	4.3/5.5	36	50	3.2	7°	3(13/80)	GIBEN	LAM1006046	
180	4.3/5.5	36	20	3.2	7°		SCHELLING - ANTHON	LAM1006047	
180	4.3/5.5	36	55	3.2	7°	3(7/66)	GABBIANI	LAM1006049	
180	4.3/5.5	36	20	3.2	7°		HOLZMA	LAM1006050	
180	4.3/5.5	36	20	3.2	7°		ANTHON LNC	LAM1006051	
200	4.3/5.5	36	45	3.2	7°		HOLZMA	LAM1006055	
200	4.3/5.5	36	50	3.2	7°	3(13/80)	GIBEN SMART	LAM1006056	
200	4.3/5.5	36	65	3.2	7°	2(9/100)+2(9/110)	SELCO	LAM1006057	
200	4.3/5.5	36	80	3.2	7°	2(14/110)	GABBIANI	LAM1006058	
200	4.3/5.5	36	22	3.2	7°			LAM1006059	
200	4.3/5.5	36	65	3.2	7°	2(8,5/110)	SELCO	LAM1006060	
200	4.3/5.5	36	20	3.2	7°			LAM1006061	
200	4.3/5.5	36	30	3.2	7°	2(9/60)	SCHEER	LAM1006063	
200	4.3/5.5	36	65	3.2	7°	2(9/100)+2(9/1109)	SELCO	LAM1006065	
200	4.3/5.5	36	20	3.2	7°		SCHELLING	LAM1006066	
200	4.3/5.5	36	20	3.2	7°		SCHELLING	LAM1006069	
215	4.3/5.5	42	50	3.2	7°	2(7/80)	GIBEN	LAM1006071	
215	4.3/5.5	42	50	3.2	7°	3(15/80)	GIBEN	LAM1006072	
220	4.3/5.5	36	20	3.2	7°		SCHELLING	LAM1006073	
300	4.3/5.5	48	50	3.2	7°	3(15/80)	GIBEN	LAM1006074	
300	4.3/5.5	72	65	3.2	7°	2(9/110)	SELCO	LAM1006075	
300	4.3/5.5	72	80	3.2	7°	2(14/110)		LAM1006076	
320	4.3/5.5	48	45	3.2	7°			LAM1006077	
320	4.3/5.5	48	50	3.2	7°	3(15/80)		LAM1006079	
340	4.7/5.9	72	45	3.5	7°	3(14/65)	HOLZMA	LAM1006080	

TOPCUT 3 LAM1007 - LAM1008



LAMA INCISORE REGOLABILE IN DIAMANTE DIA H4 - H6

PCD ADJUSTABLE SCORING BLADE H4 - H6

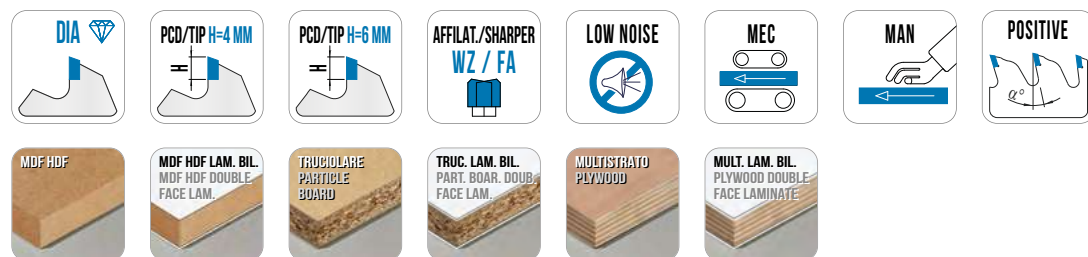

Incisore regolabile in diamante per l'incisione di pannelli bilaminati applicabile su macchine sezionatrici orizzontali.

PCD adjustable scoring blade for engraving in bilaminated panels tips H4/H6 mm.

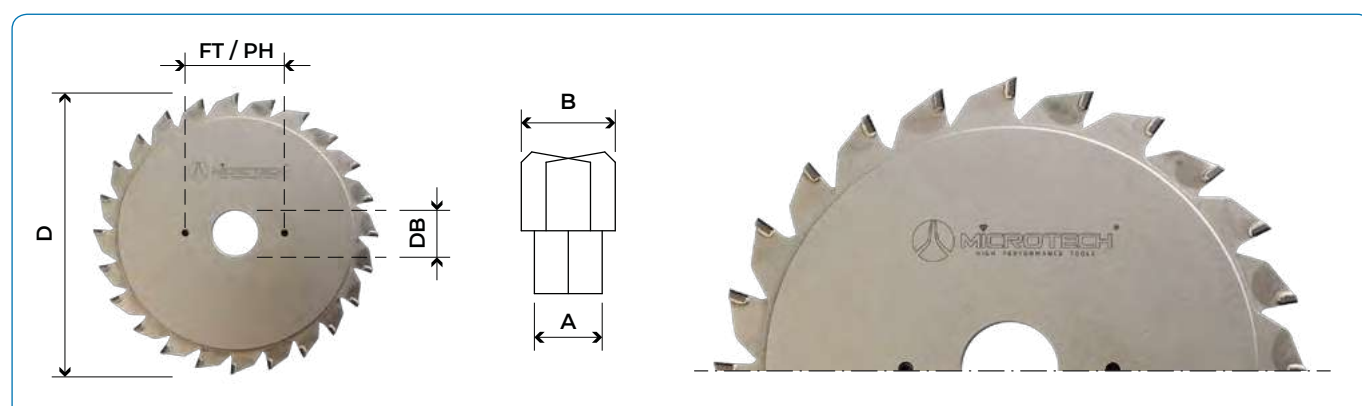

LAM1007 H PCD= 4mm				DIMENSIONI DIMENSIONS			TIPO DI MACCHINA	ARTICOLI ITEMS	PREZZI €
D	B	Z	DB	A	α°	FT / PH	MACHINE TYPES	COD / SKU	PRICE €
DIAMETER	THICKNESS	TOTAL TEETH	HOLE DIAMETER	THICKNESS	CUTTING ANGLE	PHIN HOLE			
70	2.8/3.6	8+8	20	2.2/3.0	5°	2(3,1-3,8/42)		LAM1007001	
80	2.8/3.6	6+6	20	2.2/3.0	5°	2(3,1-3,8/42)		LAM1007002	
80	2.8/3.6	10+10	20	2.2/3.0	5°	2(3,1-3,8/42)		LAM1007003	
100	2.8/3.6	10+10	20	2.2/3.0	5°	2(3,1-3,8/42)		LAM1007004	
100	2.8/3.6	12+12	22	2.2/3.0	5°	2(3,1-3,8/42)		LAM1007005	
100	2.8/3.6	12+12	20	2.2/3.0	5°	2(3,1-3,8/42)		LAM1007006	
120	2.8/3.6	12+12	20	2.2/3.0	5°	2(3,1-3,8/42)		LAM1007007	
120	2.8/3.6	12+12	22	2.2/3.0	5°	2(3,1-3,8/42)		LAM1007008	
120	2.8/3.6	12+12	22	2.2/3.0	5°	2(3,1-3,8/42)+4(4,8/38,8) S.I.+4(4,8/54,9)S.I.	OTTO MARTIN RAPIDO	LAM1007013	
120	2.8/3.6	12+12	50	2.2/3.0	5°	4(6/62)S.I.	CASOLIN	LAM1007009	
120	2.8/3.6	12+12	50	2.2/3.0	5°	4(6/62)S.I. SVAS. ANGO-LARMENTE	ALTENDORF	LAM1007010	
125	2.8/3.6	12+12	20	2.2/3.0	5°	2(3,1-3,8/42)		LAM1007011	
125	2.8/3.6	12+12	22	2.2/3.0	5°	2(3,1-3,8/42)		LAM1007012	

LAM1008 H PCD= 6mm				DIMENSIONI DIMENSIONS			TIPO DI MACCHINA	ARTICOLI ITEMS	PREZZI €
D	B	Z	DB	A	α°	FT / PH	MACHINE TYPES	COD / SKU	PRICE €
DIAMETER	THICKNESS	TOTAL TEETH	HOLE DIAMETER	THICKNESS	CUTTING ANGLE	PHIN HOLE			
70	2.8/3.6	8+8	20	2.2/3.0	5°	2/3,1 - 3,8/42		LAM1008001	
80	2.8/3.6	6+6	20	2.2/3.0	5°	2/3,1 - 3,8/42		LAM1008002	
80	2.8/3.6	10+10	20	2.2/3.0	5°	2/3,1 - 3,8/42		LAM1008003	
100	2.8/3.6	10+10	20	2.2/3.0	5°	2/3,1 - 3,8/42		LAM1008004	
100	2.8/3.6	12+12	22	2.2/3.0	5°	2/3,1 - 3,8/42		LAM1008005	
100	2.8/3.6	12+12	20	2.2/3.0	5°	2/3,1 - 3,8/42		LAM1008006	
120	2.8/3.6	12+12	20	2.2/3.0	5°	2/3,1 - 3,8/42		LAM1008007	
120	2.8/3.6	12+12	22	2.2/3.0	5°	2/3,1 - 3,8/42		LAM1008008	
120	2.8/3.6	12+12	22	2.2/3.0	5°	2(2/3,1 - 3,8/42) + 4/4,8/38,8 S.I. + 4/4,8/54,9 S.I.	OTTO MARTIN RAPIDO	LAM1008013	
120	2.8/3.6	12+12	50	2.2/3.0	5°	4/6/62 S.I.	CASOLIN	LAM1008009	
120	2.8/3.6	12+12	50	2.2/3.0	5°	4/6/62 S.I. SVAS. ANGO-LARMENTE	ALTENDORF	LAM1008010	
125	2.8/3.6	12+12	20	2.2/3.0	5°	2/3,1 - 3,8/42		LAM1008011	
125	2.8/3.6	12+12	22	2.2/3.0	5°	2/3,1 - 3,8/42		LAM1008012	

FOLDINGCUT 1 LAM1011 - LAM1012



LAMA IN DIAMANTE PER FOLDING DIA H4 - H6

PCD SAW BLADE FOR FOLDING H4 - H6

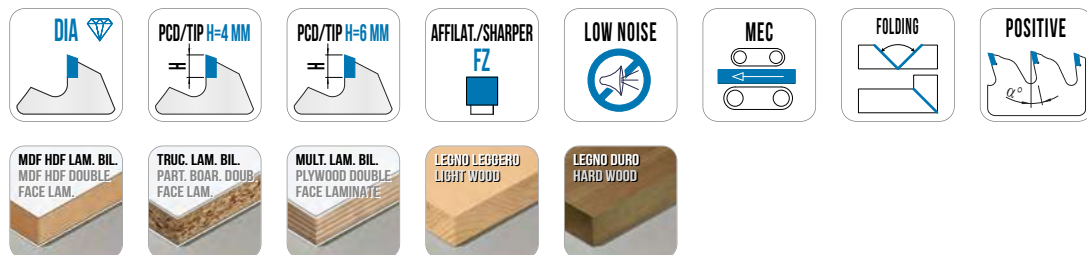

Lama in diamante per lavorazione folding su centro di lavoro CNC da utilizzare con HSK63F portalama AEM8038 o HSK alberato AEM8005.

PCD saw blade for folding to be used on CNC machine with HSK sawblade holder cod AUEM8038 o HSK with shaft cod AEM6005.

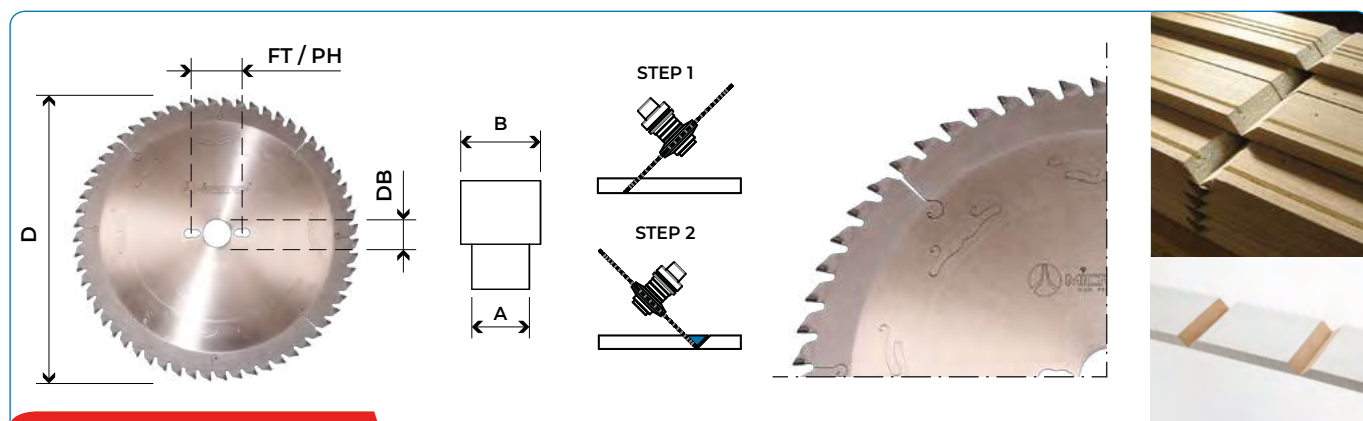

LAM1011 H PCD= 4mm			DIMENSIONI DIMENSIONS				ARTICOLI ITEMS		PREZZI €
D	B	A	DB	Z	α °	FT / PH	COD / SKU	PRICE €	
DIAMETER	THICKNESS	THICKNESS	HOLE DIAMETER	TOTAL TEETH	CUTTING ANGLE	PHIN HOLE			
250	3,2	2,2	30	48	10°	2(7/42)+2(9/46,4)+2(10/60)	LAM1011001		
250	3,2	2,2	30	54	10°	2(7/42)+2(9/46,4)+2(10/60)	LAM1011002		
250	3,2	2,2	30	60	10°	2(7/42)+2(9/46,4)+2(10/60)	LAM1011003		
250	4	3	30	48	10°	2(7/42)+2(9/46,4)+2(10/60)	LAM1011004		
250	4	3	30	54	10°	2(7/42)+2(9/46,4)+2(10/60)	LAM1011005		
250	4	3	30	60	10°	2(7/42)+2(9/46,4)+2(10/60)	LAM1011006		
300	3,2	2,2	30	48	10°	2(7/42)+2(9/46,4)+2(10/60)	LAM1011007		
300	3,2	2,2	30	60	10°	2(7/42)+2(9/46,4)+2(10/60)	LAM1011008		
300	3,2	2,2	30	72	10°	2(7/42)+2(9/46,4)+2(10/60)	LAM1011009		
300	3,2	2,2	30	96	10°	2(7/42)+2(9/46,4)+2(10/60)	LAM1011010		
300	4	3	30	48	10°	2(7/42)+2(9/46,4)+2(10/60)	LAM1011011		
300	4	3	30	60	10°	2(7/42)+2(9/46,4)+2(10/60)	LAM1011012		
300	4	3	30	72	10°	2(7/42)+2(9/46,4)+2(10/60)	LAM1011013		
300	4	3	30	96	10°	2(7/42)+2(9/46,4)+2(10/60)	LAM1011014		

LAM1012 H PCD= 6mm			DIMENSIONI DIMENSIONS				ARTICOLI ITEMS		PREZZI €
D	B	A	DB	Z	α °	FT / PH	COD / SKU	PRICE €	
DIAMETER	THICKNESS	THICKNESS	HOLE DIAMETER	TOTAL TEETH	CUTTING ANGLE	PHIN HOLE			
250	3,2	2,2	30	48	10°	2(7/42)+2(9/46,4)+2(10/60)	LAM1012001		
250	3,2	2,2	30	54	10°	2(7/42)+2(9/46,4)+2(10/60)	LAM1012002		
250	3,2	2,2	30	60	10°	2(7/42)+2(9/46,4)+2(10/60)	LAM1012003		
250	4	3	30	48	10°	2(7/42)+2(9/46,4)+2(10/60)	LAM1012004		
250	4	3	30	54	10°	2(7/42)+2(9/46,4)+2(10/60)	LAM1012005		
250	4	3	30	60	10°	2(7/42)+2(9/46,4)+2(10/60)	LAM1012006		
300	3,2	2,2	30	48	10°	2(7/42)+2(9/46,4)+2(10/60)	LAM1012007		
300	3,2	2,2	30	60	10°	2(7/42)+2(9/46,4)+2(10/60)	LAM1012008		
300	3,2	2,2	30	72	10°	2(7/42)+2(9/46,4)+2(10/60)	LAM1012009		
300	3,2	2,2	30	96	10°	2(7/42)+2(9/46,4)+2(10/60)	LAM1012010		
300	4	3	30	48	10°	2(7/42)+2(9/46,4)+2(10/60)	LAM1012011		
300	4	3	30	60	10°	2(7/42)+2(9/46,4)+2(10/60)	LAM1012012		
300	4	3	30	72	10°	2(7/42)+2(9/46,4)+2(10/60)	LAM1012013		
300	4	3	30	96	10°	2(7/42)+2(9/46,4)+2(10/60)	LAM1012014		

LAMELLO 1 LAM1009



FRESA LAMELLO PER INCASTRI CLAMEX P-SYSTEM

CLAMEX P-SYSTEM PCD BLADE FOR LAMELLO

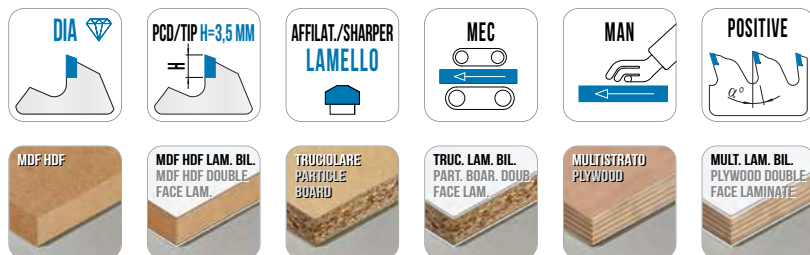

Fresa in PCD Lamello per incastri da utilizzare su macchine CNC e su fresatrice manuale ZETA P2 CLAMEX P-SYSTEM. La giunzione è perfetta per la produzione di mobili in serie o pezzi unici, nel rifacimento degli interni e per l'allestimento di negozio o stand per fiere.

PCD saw blade for LAMELLO jointing system to be used on CNC machines or portable machine Z P2.

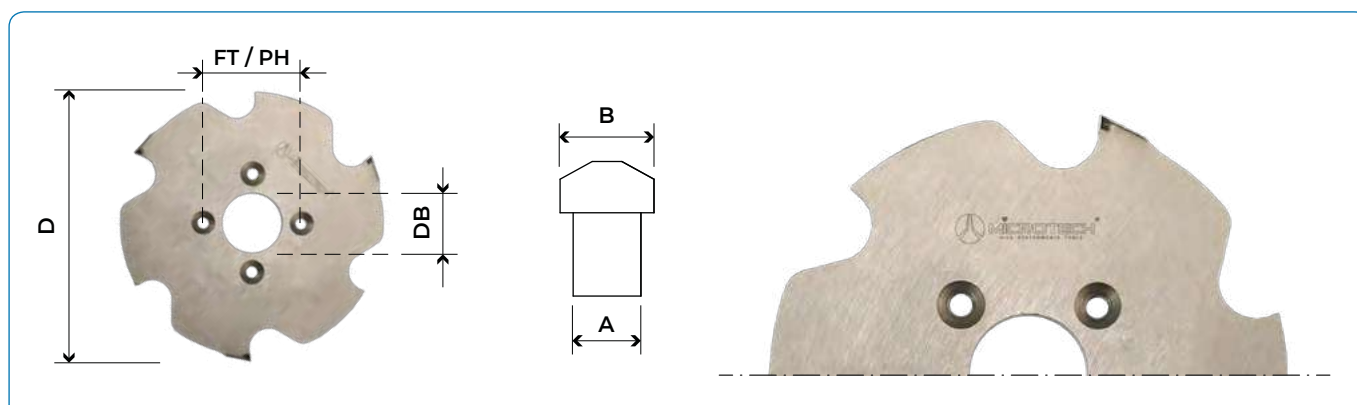

DIMENSIONI DIMENSIONS						TIPO DI MACCHINA MACHINE TYPES		ARTICOLI ITEMS	PREZZI € PRICE €
D	B	Z	DB	A	α°	FT/PH	MACHINE TYPES	COD / SKU	PRICE €
DIAMETER	THICKNESS	TOTAL TEETH	HOLE DIAMETER	THICKNESS	CUTTING ANGLE	PHIN HOLE			
100,4	7	3	22	4	10°	4(4,2/35,9)	SVAS. ANTIORARIA	MAN. ZETA P2	LAM1009001
100,4	7	6	22	4	10°	4(4,2/35,9)	SVAS. ANTIORARIA	MAN. ZETA P2	LAM1009002
100,4	7	3	30	4	10°	4(6,6/48)	SVAS. ANTIORARIA	CNC	LAM1009003
100,4	7	6	30	4	10°	4(6,6/48)	SVAS. ANTIORARIA	CNC	LAM1009004
100,4	7	3	35	4	10°	4(5,5/50)	SVAS. ANTIORARIA	BIESSE	LAM1009005
100,4	7	6	35	4	10°	4(5,5/50)	SVAS. ANTIORARIA	BIESSE	LAM1009006
100,4	7	3	40	4	10°	4(5,5/52)	SVAS. ANTIORARIA	HOMAG	LAM1009007
100,4	7	6	40	4	10°	4(5,5/52)	SVAS. ANTIORARIA	HOMAG	LAM1009008

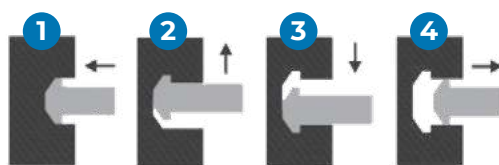

LAMELLO 2 LAM1013



FRESA LAMELLO PER INCASTRI A BISCOTTO

LAMELLO SAW BLADE FOR BISCUIT JOINTING SYSTEM

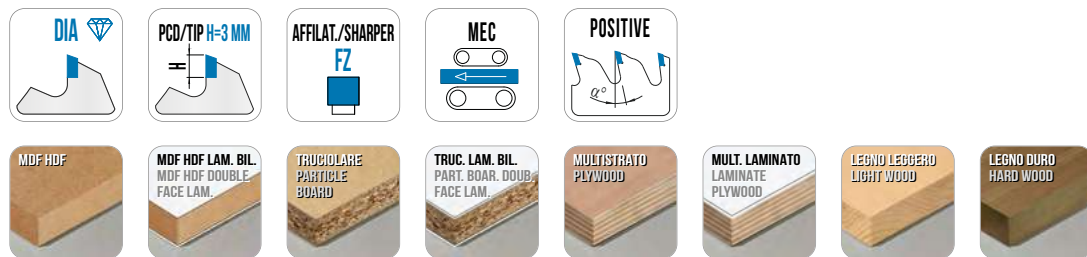

Fresa in PCD Lamello per incastri da utilizzare su macchine CNC e su fresatrici manuale zeta P2 Clamex P-system. La giunzione è perfetta per la produzione di mobili in serie o pezzi unici, nel rifacimento degli interni e per l'allestimento di negozio o stand per fiere.

PCD saw blade for LAMELLO jointing system to be used on CNC machines or portable machine Z P2.

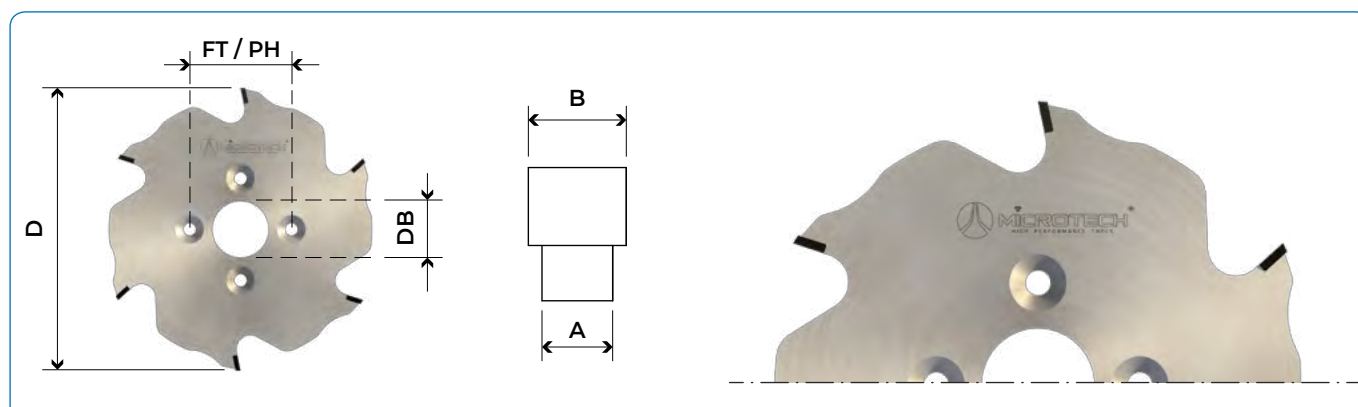

DIMENSIONI DIMENSIONS						ARTICOLI ITEMS	PREZZI €	
D	B	Z	DB	A	α°	FT / PH	COD / SKU	PRICE €
DIAMETER	THICKNESS	TOTAL TEETH	HOLE DIAMETER	THICKNESS	CUTTING ANGLE	PHIN HOLE		
100	3,96	6	22	3	10°	N4 / 4,5 / INT 35,9 SVAST. ANTIORARIA	LAM1013001	
100	3,96	8	22	3	10°	N4 / 4,5 / INT 35,9 SVAST. ANTIORARIA	LAM1013002	



MANUALCUT 1 LAM1010



LAMA IN DIAMANTE PER MACCHINE PORTATILI LAVORAZIONE DI MATERIALI DURI E ABRASIVI DIA H4
PCD SAWBLADE FOR HARD AND ABRASIVE MATERIALS

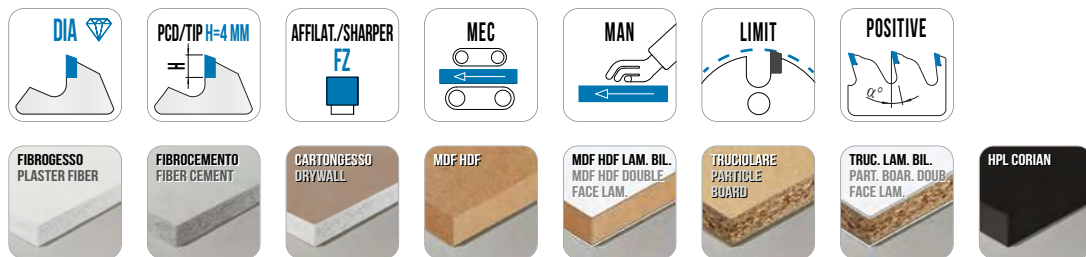

Lama in diamante per macchine portatili o a batteria per la lavorazione di materiali abrasivi come fibrocemento, cartongesso e fibrogesso.

PCD saw blade for portable or battery-powered machines for working on abrasive materials such as fiber cement, plasterboard and fiber cement.

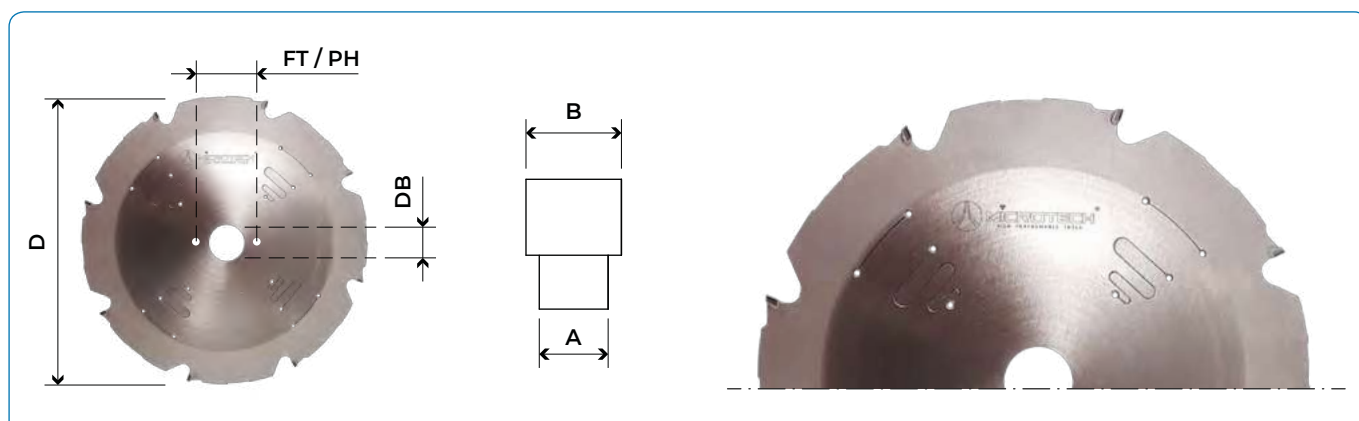

DIMENSIONI DIMENSIONS						ARTICOLI ITEMS	PREZZI €	
D DIAMETER	B THICKNESS	Z TOTAL TEETH	DB HOLE DIAMETER	A THICKNESS	α ° CUTTING ANGLE	FT / PH PHIN HOLE	COD / SKU	PRICE €
127	1,8	4	15,88	1,2	10°		LAM1010014	
160	2,4	4	20	1,6	10°	2(6/32)	LAM1010001	
160	2,4	8	20	1,6	10°	2(6/32)	LAM1010002	
160	2,4	10	20	1,6	10°	2(6/32)	LAM1010003	
180	2,2	4	20	1,6	10°	2(6/32)	LAM1010004	
184	1,8	4	15,88	1,3	10°	2(6/32)	LAM1010015	
190	2,2	4	20	1,6	10°	2(7/42)	LAM1010005	
190	2,2	4	30	1,6	10°	2(7/42)	LAM1010006	
190	2,2	12	30	1,6	10°	2(7/42)	LAM1010007	
216	2,2	8	30	1,6	10°	2(7/42)	LAM1010008	
216	2,2	14	30	1,6	10°	2(7/42)	LAM1010009	
230	2,2	4	30	1,6	10°	2(7/42)	LAM1010010	
250	2,2	12	30	1,6	10°	2(7/42)+2(9/46,4)+2(10/60)	LAM1010011	
250	2,2	16	30	1,6	10°	2(7/42)+2(9/46,4)+2(10/60)	LAM1010012	
300	2,2	20	30	1,6	10°	2(7/42)+2(9/46,4)+2(10/60)	LAM1010013	

CUTPLUS 2 LAM1514

HW

LAMA IN HW PER SQUADRARE LEGNO AD ALTO RENDIMENTO
HIGH PERFORMANCE SAW BLADE FOR SQUARING IN HW

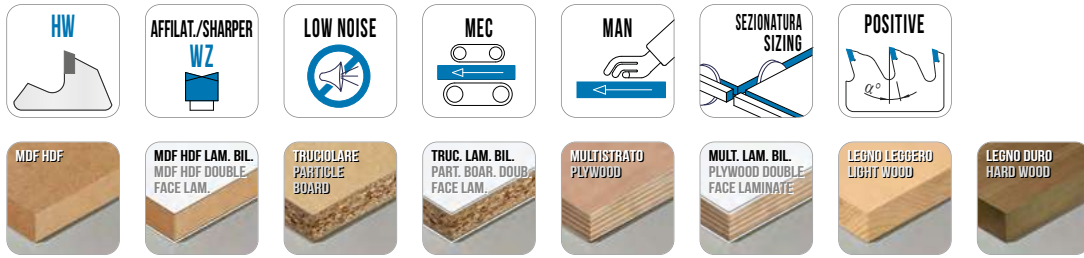

Lama in HW per seghe circolari a banco e sezionatrici orizzontali. ideali per la sezionatura di pannelli bilaminati senza l'uso dell'incisore particolarmente adatta per lavorazione legno.

HW saw blade suitable for sizing laminated panels on sliding table saw, horizontal panel saw without using scoring blade.

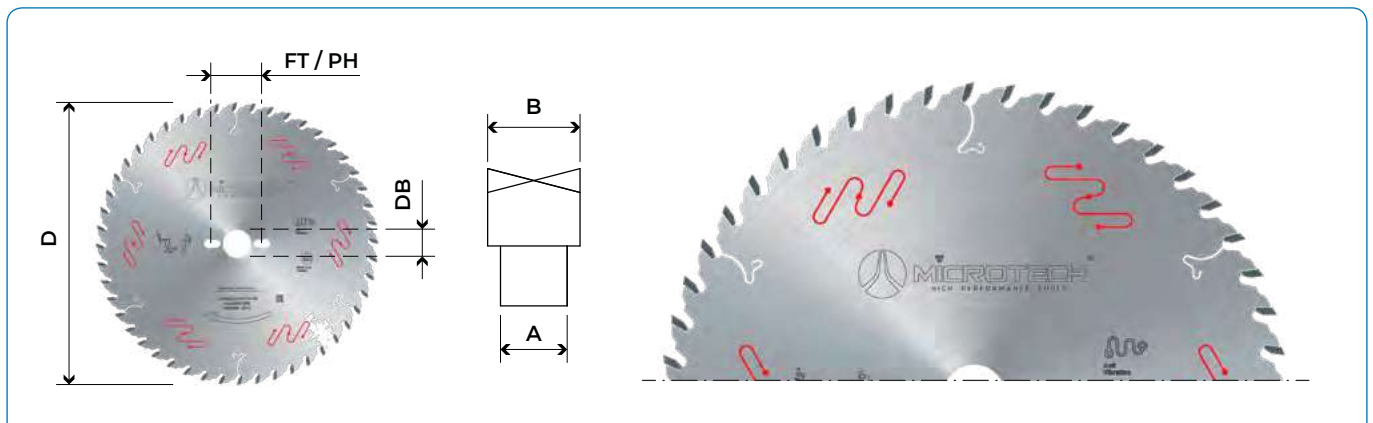

DIMENSIONI DIMENSIONS						ARTICOLI ITEMS	PREZZI €		
D	B	Z	DB	A	α °	FT / PH	PASSO TYPE	COD / SKU	PRICE €
DIAMETER	THICKNESS	TOTAL TEETH	HOLE DIAMETER	THICKNESS	CUT. ANGLE	PHIN HOLE			
250	3,2	40	30	2,2	10°	2(7/42)+2(9/46,4)+2(10/60)	PASSO FISSO	LAM1514001	
250	3,2	48	30	2,2	10°	2(7/42)+2(9/46,4)+2(10/60)	PASSO VARIABILE	LAM1514002	
250	3,2	48	30	2,2	10°	2(7/42)+2(9/46,4)+2(10/60)	PASSO FISSO	LAM1514003	
250	3,2	54	30	2,2	10°	2(7/42)+2(9/46,4)+2(10/60)	PASSO VARIABILE	LAM1514004	
250	3,2	54	30	2,2	10°	2(7/42)+2(9/46,4)+2(10/60)	PASSO FISSO	LAM1514005	
250	3,2	60	30	2,2	10°	2(7/42)+2(9/46,4)+2(10/60)	PASSO FISSO	LAM1514006	
300	3,2	48	30	2,2	10°	2(7/42)+2(9/46,4)+2(10/60)	PASSO FISSO	LAM1514007	
300	3,2	60	30	2,2	10°	2(7/42)+2(9/46,4)+2(10/60)	PASSO VARIABILE	LAM1514008	
300	3,2	60	30	2,2	10°	2(7/42)+2(9/46,4)+2(10/60)	PASSO FISSO	LAM1514009	
300	3,2	72	30	2,2	10°	2(7/42)+2(9/46,4)+2(10/60)	PASSO VARIABILE	LAM1514010	
300	3,2	72	30	2,2	10°	2(7/42)+2(9/46,4)+2(10/60)	PASSO FISSO	LAM1514011	
300	3,2	80	30	2,2	10°	2(7/42)+2(9/46,4)+2(10/60)	PASSO VARIABILE	LAM1514012	
300	3,2	80	30	2,2	10°	2(7/42)+2(9/46,4)+2(10/60)	PASSO FISSO	LAM1514013	
300	3,2	96	30	2,2	10°	2(7/42)+2(9/46,4)+2(10/60)	PASSO FISSO	LAM1514014	
350	3,5	54	30	2,5	10°	2(7/42)+2(9/46,4)+2(10/60)	PASSO FISSO	LAM1514015	
350	3,5	72	30	2,5	10°	2(7/42)+2(9/46,4)+2(10/60)	PASSO VARIABILE	LAM1514016	
350	3,5	72	30	2,5	10°	2(7/42)+2(9/46,4)+2(10/60)	PASSO FISSO	LAM1514017	
350	3,5	84	30	2,5	10°	2(7/42)+2(9/46,4)+2(10/60)	PASSO VARIABILE	LAM1514018	
350	3,5	84	30	2,5	10°	2(7/42)+2(9/46,4)+2(10/60)	PASSO FISSO	LAM1514019	
350	3,5	96	30	2,5	10°	2(7/42)+2(9/46,4)+2(10/60)	PASSO VARIABILE	LAM1514020	
350	3,5	96	30	2,5	10°	2(7/42)+2(9/46,4)+2(10/60)	PASSO FISSO	LAM1514021	
350	3,5	108	30	2,5	10°	2(7/42)+2(9/46,4)+2(10/60)	PASSO FISSO	LAM1514022	
400	4	60	30	2,8	10°	2(7/42)+2(9/46,4)+2(10/60)	PASSO FISSO	LAM1514023	
400	4	80	30	2,8	10°	2(7/42)+2(9/46,4)+2(10/60)	PASSO FISSO	LAM1514024	
400	4	96	30	2,8	10°	2(7/42)+2(9/46,4)+2(10/60)	PASSO FISSO	LAM1514025	
400	4	120	30	2,8	10°	2(7/42)+2(9/46,4)+2(10/60)	PASSO FISSO	LAM1514026	

CUTPLUS 3 LAM1515

HW

LAMA IN HW PER SQUADRARE TRUCIOLARE E MDF

HW SAW BLADE FOR SQUARING CHEAPBOARD AND MDF

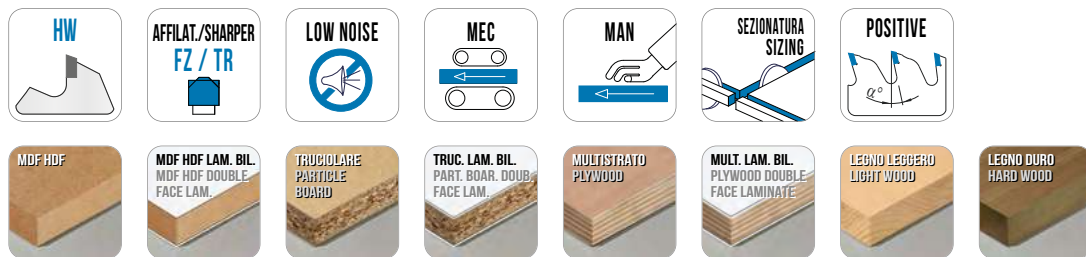

Lama in HW per seghe circolari a banco e sezionatrici orizzontali. Ideali per la sezionatura di pannelli bilaminati con l'uso dell'incisore particolarmente adatta per lavorazione truciolare e MDF.

HW saw blade suitable for sizing laminated panels, cheapboard, MDF on sliding table saw, horizontal panel saw using scoring blade.

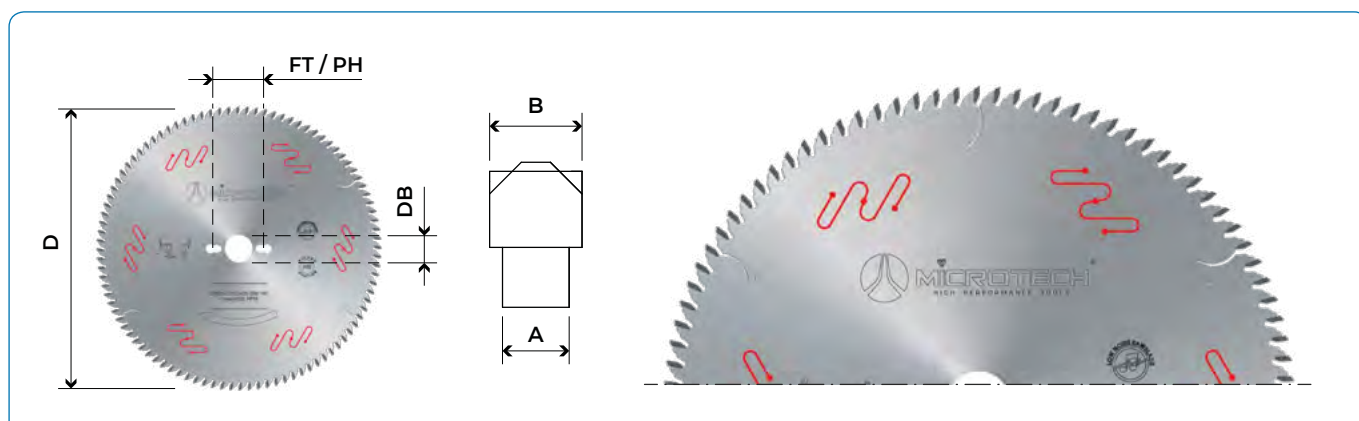

DIMENSIONI DIMENSIONS						ARTICOLI ITEMS	PREZZI €		
D	B	Z	DB	A	α °	FT / PH	PASSO	COD / SKU	PRICE €
DIAMETER	THICKNESS	TOTAL TEETH	HOLE DIAMETER	THICKNESS	CUT. ANGLE	PHIN HOLE	TYPE		
200	3,2	64	30	2,2	10°	2(7/42)+2(9/46,4)+2(10/60)	PASSO FISSO	LAM1515001	
220	3,2	64	30	2,2	10°	2(7/42)+2(9/46,4)+2(10/60)	PASSO FISSO	LAM1515002	
250	3,2	60	30	2,2	10°	2(7/42)+2(9/46,4)+2(10/60)	PASSO FISSO	LAM1515003	
250	3,2	80	30	2,2	10°	2(7/42)+2(9/46,4)+2(10/60)	PASSO FISSO	LAM1515004	
300	3,2	72	30	2,2	10°	2(7/42)+2(9/46,4)+2(10/60)	PASSO VARIABILE	LAM1515005	
300	3,2	72	30	2,2	10°	2(7/42)+2(9/46,4)+2(10/60)	PASSO FISSO	LAM1515006	
300	3,2	96	30	2,2	10°	2(7/42)+2(9/46,4)+2(10/60)	PASSO FISSO	LAM1515007	
350	3,5	84	30	2,5	10°	2(7/42)+2(9/46,4)+2(10/60)	PASSO VARIABILE	LAM1515008	
350	3,5	84	30	2,5	10°	2(7/42)+2(9/46,4)+2(10/60)	PASSO FISSO	LAM1515009	
350	3,5	108	30	2,5	10°	2(7/42)+2(9/46,4)+2(10/60)	PASSO FISSO	LAM1515010	
400	4	108	30	2,8	10°	2(7/42)+2(9/46,4)+2(10/60)	PASSO FISSO	LAM1515011	

TOPCUT 4 LAM1516

HW

LAMA INCISORE CONICO IN WIIDIA
CONICAL SCORING BLADE IN HW

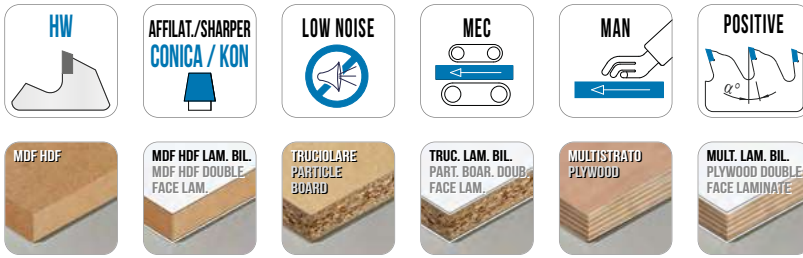

Incisore in HW per sezionatrici per pannelli di truciolare rivestiti con carta o plastica, truciolare impiallacciati, legni stratificati come compensato.

HW conical scoring blade suitable for working laminated panels with paper and veneer, plywood.

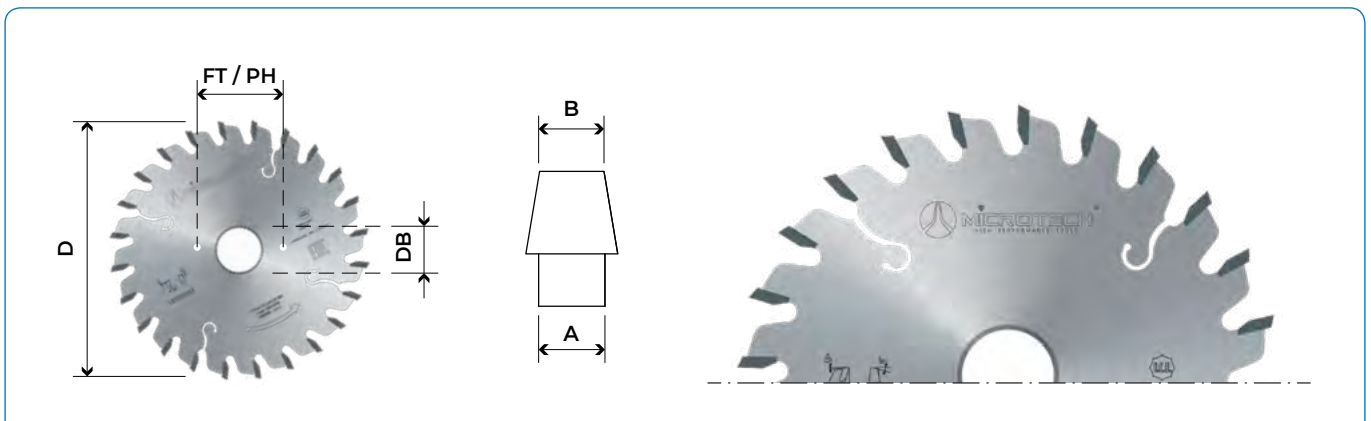

DIMENSIONI DIMENSIONS						TIPO DI MACCHINA	ARTICOLI	ITEMS	PREZZI €
D	B	Z	DB	A	α°	FT / PH	MACHINE TYPES	COD / SKU	PRICE €
DIAMETER	THICKNESS	TOTAL TEETH	HOLE DIAMETER	THICKNESS	CUT ANGLE	PHIN HOLE			
80	3,1/4,0	12	20	2,2	5°			LAM1516001	
90	3,0/4,1	12	30	2,2	5°			LAM1516002	
100	3,1/4,3	20	20	2,2	5°			LAM1516003	
100	3,1/4,3	24	20	2,2	5°			LAM1516004	
110	3,1/4,3	20	20	2,2	5°			LAM1516005	
120	3,1/4,3	20	20	2,2	5°			LAM1516006	
120	3,1/4,3	20	22	2,2	5°			LAM1516007	
120	3,4/4,5	20	20	2,2	5°			LAM1516008	
125	3,1/4,3	24	20	2,2	5°			LAM1516009	
125	3,1/4,3	24	22	2,2	5°			LAM1516010	
125	3,4/4,5	24	20	2,2	5°			LAM1516011	
125	4,3/5,5	24	20	3,2	5°			LAM1516012	
125	4,3/5,5	24	22	3,2	5°			LAM1516013	
125	4,3/5,5	24	45	3,2	5°			LAM1516014	
140	3,1/4,3	24	20	2,2	5°			LAM1516015	
140	4,3/5,5	24	45	3,2	5°	1/08/58,		LAM1516016	
150	4,3/5,5	24	20	3,2	5°			LAM1516017	
150	4,3/5,5	24	30	3,2	5°			LAM1516018	
150	4,3/5,5	24	45	3,2	5°			LAM1516019	
150	3,1/4,3	36	30	2,2	5°			LAM1516020	
150	3,4/4,5	36	30	2,2	5°			LAM1516021	
150	3,9/5,1	36	30	2,8	5°			LAM1516022	
150	4,3/5,5	36	30	3,2	5°			LAM1516023	
150	4,3/5,5	36	45	3,2	7°	3/11/70	GIBEN	LAM1516024	
150	4,3/5,5	36	55	3,2	7°	3/7/66+3/6/84	GABBIANI	LAM1516025	
160	4,3/5,5	36	20	3,2	7°			LAM1516026	

D		B	Z	DB	DIMENSIONI DIMENSIONS		TIPO DI MACCHINA	ARTICOLI ITEMS	PREZZI €
DIAMETER	THICKNESS	TOTAL TEETH	HOLE DIAMETER	A	α °	FT / PH PHIN HOLE	MACHINE TYPES	COD / SKU	PRICE €
160	4,3/5,5	36	30	3,2	7°			LAM1516027	
160	4,3/5,5	36	45	3,2	7°	3/11/70	GIBEN	LAM1516028	
160	4,3/5,5	36	55	3,2	7°	3/7/66+3/9/72	GABBIANI MACMAZZA	LAM1516029	
160	4,5/5,7	36	45	3,2	7°	3/11/70	GIBEN	LAM1516030	
160	4,5/5,7	36	55	3,2	7°	3/7/66+3/9/72	GABBIANI	LAM1516031	
160	4,7/6,0	36	55	3,5	7°	3/7/66+3/9/72	GABBIANI	LAM1516032	
180	4,3/5,5	36	20	3,2	7°			LAM1516033	
180	4,3/5,5	36	30	3,2	7°	2/10/60,		LAM1516034	
180	4,3/5,5	36	45	3,2	7°		HOLZMA	LAM1516035	
180	4,3/5,5	36	55	3,2	7°	3/7/66	GABBIANI	LAM1516036	
180	4,7/6,0	36	45	3,5	7°		HOLZMA	LAM1516037	
180	4,7/6,0	36	50	3,5	7°	3/13/80	GIBEN	LAM1516038	
180	5,0/6,2	36	55	3,5	7°		GIBEN	LAM1516039	
180	5,8/7,0	36	20	4	7°		ANTHON	LAM1516040	
180	6,2/7,2	36	20	4	7°		ANTHON	LAM1516041	
180	6,8/7,8	36	20	5	7°		SHELLING	LAM1516042	
180	4,3/5,5	44	50	3,2	7°	3/13/80	GIBEN	LAM1516043	
190	4,0/5,1	36	50	2,8	7°	3/13/80	GIBEN	LAM1516044	
200	4,3/5,5	36	20	3,2	7°			LAM1516045	
200	4,3/5,5	36	30	3,2	7°	2/10/60,		LAM1516046	
200	4,3/5,5	36	45	3,2	7°		HOLZMA	LAM1516047	
200	4,3/5,5	36	65	3,2	7°	2/9/100+2/9/110	SELCO	LAM1516048	
200	4,3/5,5	36	80	3,2	7°	2/14/110	GABBIANI	LAM1516049	
200	4,5/5,7	36	65	3,2	7°	2/8,5/110	SELCO	LAM1516050	
200	4,7/6,0	36	45	3,5	7°		HOLZMA	LAM1516051	
200	4,7/6,0	36	65	3,5	7°		SELCO	LAM1516052	
200	5,0/6,2	36	20	3,5	7°		SHELLING	LAM1516053	
200	5,0/6,2	36	65	3,5	7°		SELCO	LAM1516054	
200	5,8/7,0	36	45	4	7°		HOLZMA	LAM1516055	
200	6,2/7,2	36	20	4	7°		SHELLING	LAM1516056	
200	6,2/7,2	36	45	4,4	7°		HOLZMA	LAM1516057	
215	4,3/5,5	42	50	3,2	7°	2/7/80	GIBEN	LAM1516058	
215	4,5/5,7	42	50	3,2	7°	3/15/80	GIBEN	LAM1516059	
250	4,3/5,5	60	30	3,2	7°	2/10/60		LAM1516060	
250	4,5/5,7	60	30	3,2	7°	2/10/60		LAM1516061	
280	4,3/5,5	48	55	3,2	7°		MACMAZZA	LAM1516062	
280	4,5/5,6	48	55	3,2	7°		MACMAZZA	LAM1516063	
300	4,3/5,5	48	30	3,2	7°	2/10/60		LAM1516064	
300	4,3/5,5	48	50	3,2	7°	3/15/80	GIBEN	LAM1516065	
300	4,3/5,5	72	65	3,2	7°	2/9/110	SELCO	LAM1516066	
300	4,3/5,3	72	80	3,2	7°	2/14/110	GABBANI	LAM1516067	
300	4,5/5,7	48	50	3,2	7°	3/15/80	GIBEN	LAM1516068	
300	4,5/5,7	72	65	3,2	7°	2/9/110	SELCO	LAM1516069	
300	4,7/6,0	72	65	3,5	7°	2/9/110	SELCO	LAM1516070	

TOPCUT 5 LAM1517

HW

LAMA IN HW CON LIMITATORE DI TRUCIOLO

HW SAW BLADE WITH CHIP LIMITER

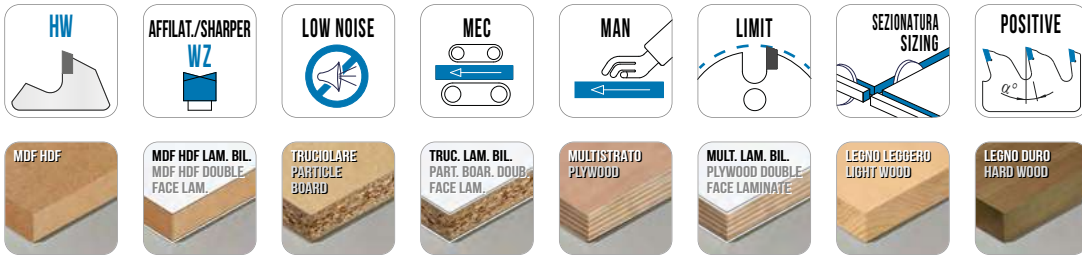

Lama industriale con limitatore di truciolo per tagli lungo vena.

Industrial circular saw blade hw for rip and glue line rip cuts.

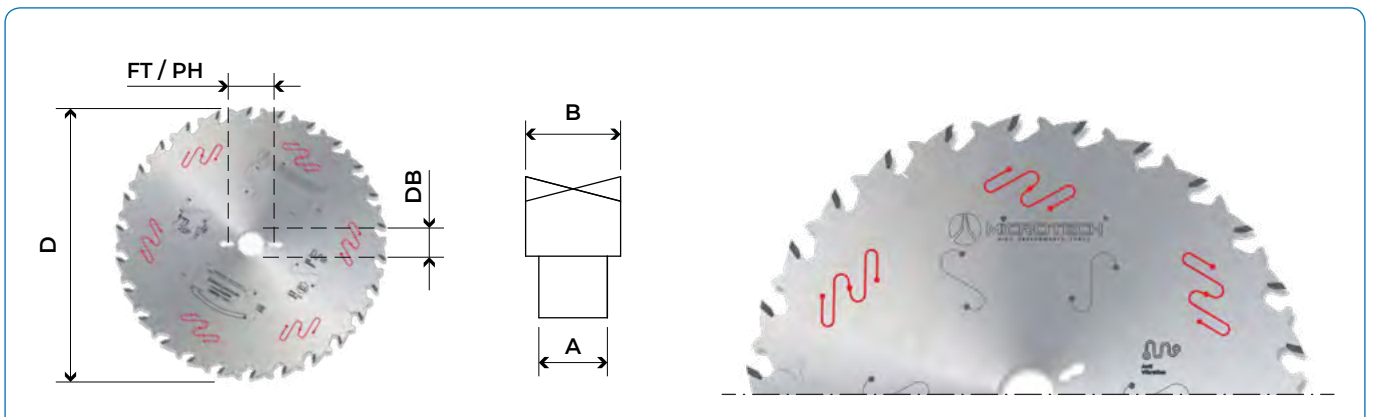

DIMENSIONI DIMENSIONS						ARTICOLI ITEMS	PREZZI €		
D	B	Z	DB	A	α °	FT / PH	PASSO	COD / SKU	PRICE €
DIAMETER	THICKNESS	TOTAL TEETH	HOLE DIAMETER	THICKNESS	CUT. ANGLE	PHIN HOLE	TYPE		
250	3,2	22	30	2.2	20°	2(7/42)+2(9/46,4)+2(10/60)	PASSO FISSO	LAM1517001	
300	3,2	26	30	2.2	20°	2(7/42)+2(9/46,4)+2(10/60)	PASSO FISSO	LAM1517002	
350	3,5	30	30	2,5	20°	2(7/42)+2(9/46,4)+2(10/60)	PASSO FISSO	LAM1517003	
400	4	34	30	2,8	20°	2(7/42)+2(9/46,4)+2(10/60)	PASSO FISSO	LAM1517004	
450	4,4	38	30	3	20°	2(7/42)+2(9/46,4)+2(10/60)	PASSO FISSO	LAM1517005	
500	4,4	42	30	3,2	20°	2(7/42)+2(9/46,4)+2(10/60)	PASSO FISSO	LAM1517006	

TOPCUT 6 LAM1518

HW

LAMA IN HW CON TAGLIENTE CONCAVO

HW SAW BLADE WITH HZ TEETH

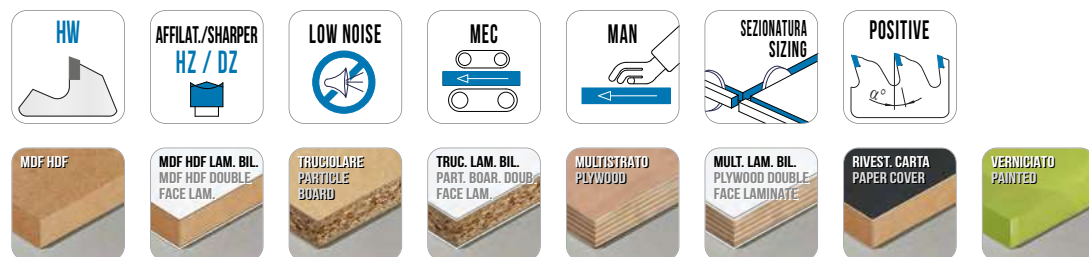

Lama in HW per squadrare e troncare senza incidere. Ottima per sezionatrici verticali senza l'ausilio dell'incisore.

HW saw blade suitable for sizing laminated panels on vertical panel saw saw without using scoring blade.

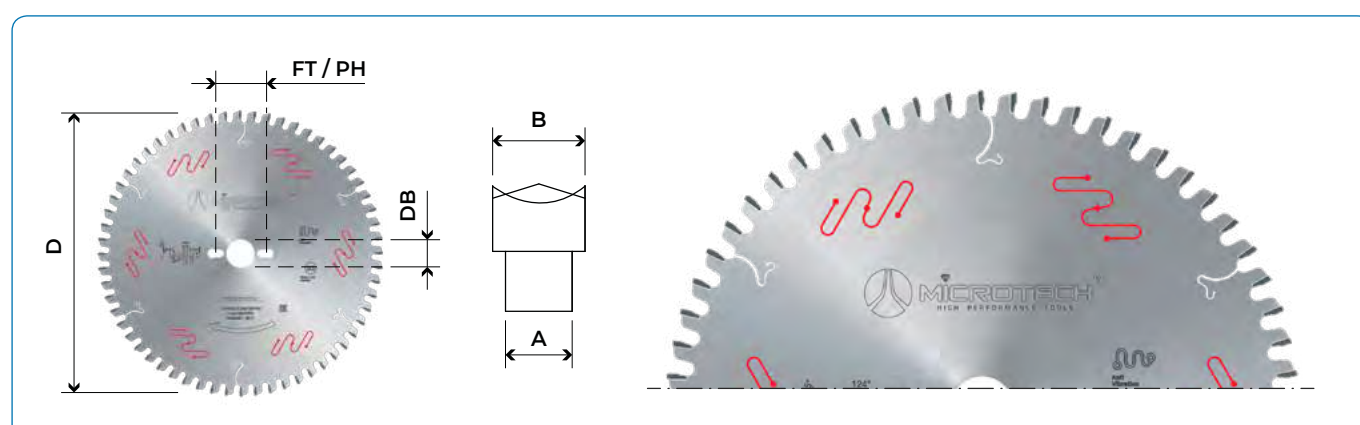

DIMENSIONI DIMENSIONS						ARTICOLI ITEMS	PREZZI €		
D	B	Z	DB	A	α °	FT / PH	PASSO TYPE	COD / SKU	PRICE €
DIAMETER	THICKNESS	TOTAL TEETH	HOLE DIAMETER	THICKNESS	CUT. ANGLE	PHIN HOLE			
220	3,2	42	30	2.2	10°	2(7/42)+2(9/46,4)+2(10/60)	PASSO FISSO	LAM1518001	
250	3,2	48	30	2.2	10°	2(7/42)+2(9/46,4)+2(10/60)	PASSO FISSO	LAM1518002	
300	3,2	60	30	2.2	10°	2(7/42)+2(9/46,4)+2(10/60)	PASSO FISSO	LAM1518003	
303	3,2	60	30	2.2	10°	2(7/42)+2(9/46,4)+2(10/60)	PASSO FISSO	LAM1518004	
350	3,2	72	30	2.2	10°	2(7/42)+2(9/46,4)+2(10/60)	PASSO FISSO	LAM1518005	



TOPCUT 7 LAM1519

HW

LAMA CIRCOLARE CON RASANTI PER MULTILAMA
HW SAW BLADE MULTI RIP

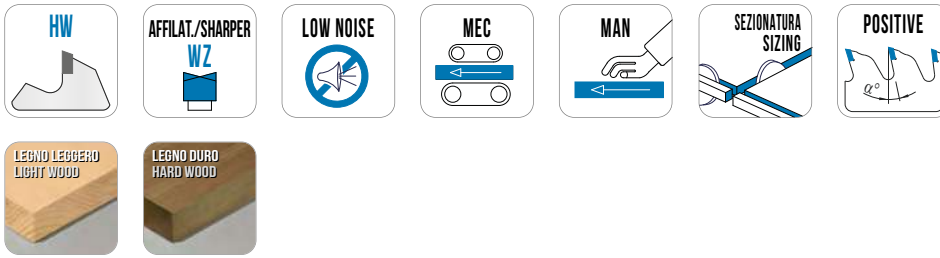

Lama circolare con rasanti interni per taglio lungo vena del bordo e di rifilatura per macchine multilama, macchine monolama e seghe circolari.

HW saw blade with inside shaver for cutting a long the grain on multiprip saw and manual cutting machine.

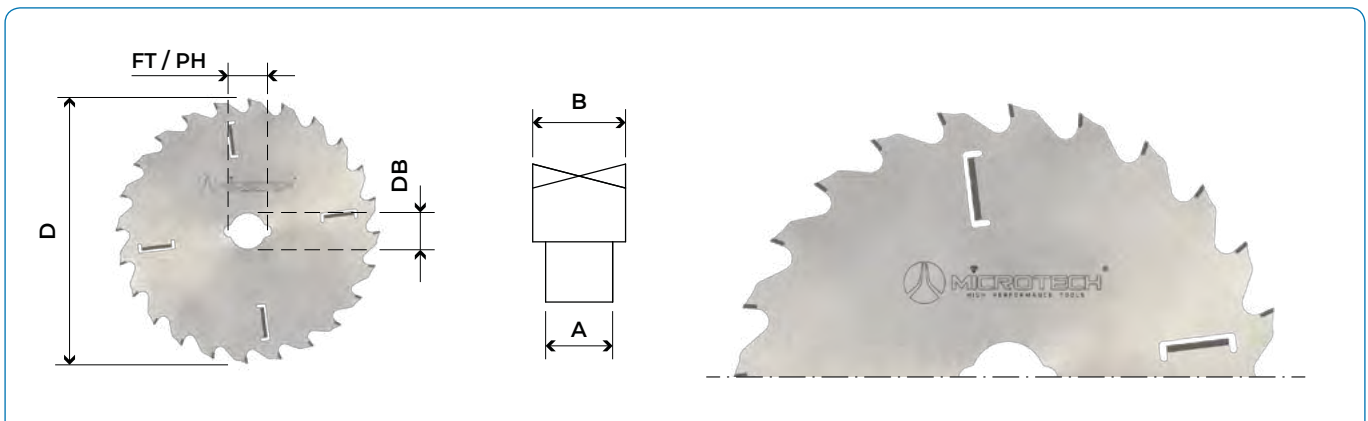

DIMENSIONI DIMENSIONS								ARTICOLI ITEMS	PREZZI €		
D	LU	B	Z	DB	A	α°	DKN	FT / PH PHIN HOLE	PASSO TYPE	COD / SKU	PRICE €
DIAMETER	US. LENGHT	THICN.	T. TEETH	HOLE DIAM.	THICN.	C. ANGLE					
250	65	3,2	20+2+2	30	2,2	10°		2(7/42)+2(9/46,4)+2(10/60)	PASSO FISSO	LAM1519001	
250	65	3,2	20+2+2	60	2,2	10°	21x74		PASSO FISSO	LAM1519002	
250	65	3,2	20+2+2	70	2,2	10°	21x84		PASSO FISSO	LAM1519003	
250	65	3,2	20+2+2	80	2,2	10°	13x90		PASSO FISSO	LAM1519004	
280	70	3,2	24+2+2	70	2,2	10°	21x84		PASSO FISSO	LAM1519005	
280	70	3,2	24+2+2	80	2,2	10°	13x90		PASSO FISSO	LAM1519006	
300	80	3,2	24+2+2	30	2,2	10°		2(7/42)+2(9/46,4)+2(10/60)	PASSO FISSO	LAM1519007	
300	80	3,2	24+2+2	50	2,2	10°			PASSO FISSO	LAM1519008	
300	80	3,2	24+2+2	60	2,2	10°	21x74		PASSO FISSO	LAM1519009	
300	80	3,2	24+2+2	70	2,2	10°	21x84		PASSO FISSO	LAM1519010	
300	80	3,2	24+2+2	75	2,2	10°	21x91		PASSO FISSO	LAM1519011	
300	80	3,2	24+2+2	80	2,2	10°	13x90		PASSO FISSO	LAM1519012	
300	80	3,2	24+2+2	80	2,2	10°	18,5x87	6 (5,5/91)+2 (13/100)+4(6,6/95)	PASSO FISSO	LAM1519013	
300	80	3,4	24+2+2	80	2,2	10°	13x90		PASSO FISSO	LAM1519014	
320	90	3,2	24+2+2	70	2,2	10°	21x84		PASSO FISSO	LAM1519015	
320	90	3,2	24+2+2	80	2,2	10°	13x90		PASSO FISSO	LAM1519016	
320	85	3,2	24+2+2	90	2,2	10°	21x110		PASSO FISSO	LAM1519017	
320	85	3,2	24+2+2	100	2,2	10°	13x110		PASSO FISSO	LAM1519018	
350	105	3,5	24+2+4	30	2,5	10°		2(7/42)+2(9/46,4)+2(10/60)	PASSO FISSO	LAM1519019	
350	105	3,5	24+2+4	50	2,5	10°			PASSO FISSO	LAM1519020	
350	105	3,5	24+2+4	60	2,5	10°	21x74		PASSO FISSO	LAM1519021	
350	105	3,5	24+2+4	70	2,5	10°	21x84		PASSO FISSO	LAM1519022	
350	105	3,5	24+2+4	75	2,5	10°	21x91		PASSO FISSO	LAM1519023	
350	105	3,5	24+2+4	80	2,5	10°	14x92		PASSO FISSO	LAM1519024	
350	105	3,5	24+2+4	80	2,5	10°	18,5x87	6 (5,5/91)+2 (13/100)+4(6,6/95)	PASSO FISSO	LAM1519025	
350	95	3,5	24+2+4	90	2,5	10°	21x110		PASSO FISSO	LAM1519026	

DIMENSIONI DIMENSIONS								ARTICOLI ITEMS	PREZZI €		
D	LU	B	Z	DB	A	α °	DKN	FT / PH PHIN HOLE	PASSO FISSO TYPE	COD / SKU	PRICE €
DIAMETER	US. LENGHT	THICN.	T. TEETH	HOLE DIAM.	THICN.	C. ANGLE					
350	95	3,5	24+2+4	95	2,5	10°	21x109		PASSO FISSO	LAM1519027	
350	95	3,5	24+2+4	100	2,5	10°	13x112		PASSO FISSO	LAM1519028	
350	95	3,5	24+2+4	105	2,5	10°	21x119		PASSO FISSO	LAM1519029	
350	105	3,8	24+2+4	30	2,5	10°			PASSO FISSO	LAM1519030	
350	105	3,8	24+2+4	70	2,5	10°	21x84		PASSO FISSO	LAM1519031	
350	105	3,8	24+2+4	80	2,5	10°	14x92		PASSO FISSO	LAM1519032	
350	95	3,8	24+2+4	90	2,5	10°	21x110		PASSO FISSO	LAM1519033	
380	115	4,0	28+2+4	70	2,8	10°	21x84		PASSO FISSO	LAM1519034	
380	115	4,0	28+2+4	75	2,8	10°	21x91		PASSO FISSO	LAM1519035	
380	115	4,0	28+2+4	100	2,8	10°	13x112		PASSO FISSO	LAM1519036	
400	120	4,0	28+2+4	30	2,8	10°		2(7/42)+2(9/46,4)+2(10/60)	PASSO FISSO	LAM1519037	
400	120	4,0	28+2+4	50	2,8	10°			PASSO FISSO	LAM1519038	
400	120	4,0	28+2+4	70	2,8	10°	21x84		PASSO FISSO	LAM1519039	
400	120	4,0	28+2+4	75	2,8	10°	21x91		PASSO FISSO	LAM1519040	
400	120	4,0	28+2+4	80	2,8	10°	14x92		PASSO FISSO	LAM1519041	
400	120	4,0	28+2+4	90	2,8	10°	21x110		PASSO FISSO	LAM1519042	
400	120	4,0	28+2+4	95	2,8	10°	21x109		PASSO FISSO	LAM1519043	
400	120	4,0	28+2+4	100	2,8	10°	13x112		PASSO FISSO	LAM1519044	
400	120	4,0	28+2+4	110	2,8	10°	21x130		PASSO FISSO	LAM1519045	

TOPCUT 8 LAM1520

HW

LAMA CIRCOLARE IN HW PER SEZIONATARICI

HW SAW BLADE FOR CUTTING

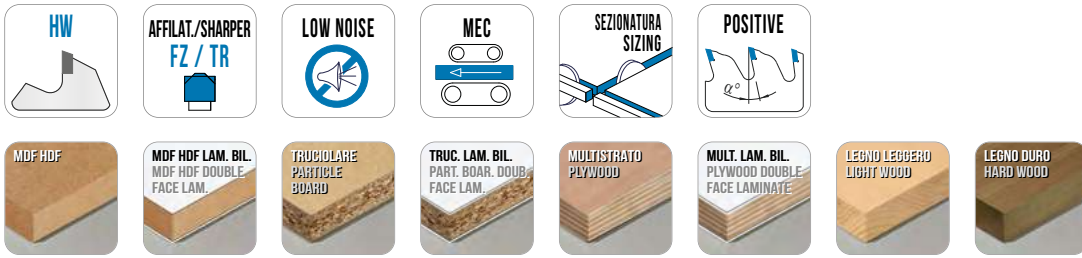

Lama circolare per sezionare pannelli singoli e a pacco con incisore.

HW saw blade for cutting single or not panels using scoring blade.

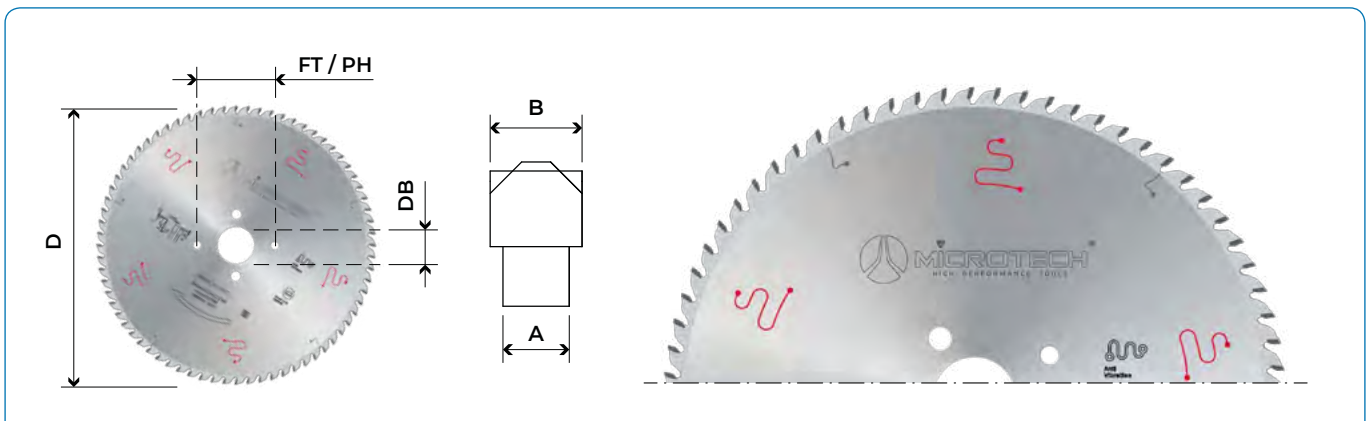

DIMENSIONI DIMENSIONS						TIPO DI MACCHINA	ARTICOLI	ITEMS	PREZZI €	
D	B	Z	DB	A	α °	FT / PH	PASSO	MACHINE TYPES	COD / SKU	PRICE €
DIAMETER	THICN.	T. TEETH	HOLE DIAM.	THICN.	C. ANGLE	PHIN HOLE	TYPE			
300	4,4	60	30	3,2	10°	2/7/42 +2/9,5/45,5 +2/10/60	PASSO FISSO		LAM1520001	
300	4,4	60	65	3,2	10°	2/9/110	PASSO FISSO	SELCO	LAM1520002	
300	4,4	60	75	3,2	10°	4/15/105 + 3/7/100	PASSO FISSO		LAM1520003	
300	4,4	60	80	3,2	10°	2/14/110+4/9/100	PASSO FISSO	GABBIANI	LAM1520004	
300	4,4	72	30	3,2	10°	2/7/42 +2/9,5/45,5 +2/10/60	PASSO FISSO		LAM1520005	
300	4,4	72	65	3,2	10°	2/9/110	PASSO FISSO	SELCO	LAM1520006	
300	4,4	72	80	3,2	10°	2/14/110+4/9/100	PASSO FISSO	GABBIANI	LAM1520007	
320	4,4	60	50	3,2	10°	4/13/80	PASSO FISSO	GIBEN	LAM1520008	
320	4,4	60	65	3,2	10°	2/9/110	PASSO FISSO	SELCO	LAM1520009	
320	4,4	60	80	3,2	10°	2/14/110 +2/7/110+4/19/120+2/9/130	PASSO FISSO		LAM1520010	
320	4,4	72	50	3,2	10°	4/13/80	PASSO FISSO	GIBEN	LAM1520011	
320	4,4	72	75	3,2	10°		PASSO FISSO	GIBEN - MACMAZZA	LAM1520012	
320	4,6	60	65	3,2	10°	2/9/110	PASSO FISSO	SELCO	LAM1520013	
330	4,4	60	50	3,2	10°	4/13/80	PASSO FISSO	GIBEN	LAM1520014	
350	4,25	72	30	3,2	10°	2/7/42 +2/9,5/45,5 +2/10/60	PASSO FISSO		LAM1520015	
350	4,4	54	30	3,2	10°	2/7/42 +2/9,5/45,5 +2/10/60	PASSO FISSO		LAM1520016	
350	4,4	54	75	3,2	10°		PASSO FISSO		LAM1520017	
350	4,4	54	80	3,2	10°	2/14/110 +2/7/110+4/19/120+2/9/130	PASSO FISSO		LAM1520018	
350	4,4	72	30	3,2	10°	2/7/42 +2/9,5/45,5 +2/10/60	PASSO FISSO		LAM1520019	
350	4,4	72	50	3,2	10°	4/13/80	PASSO FISSO	GIBEN	LAM1520020	
350	4,4	72	60	3,2	10°	2/14/100	PASSO FISSO	HOLZMA	LAM1520021	
350	4,4	72	65	3,2	10°	2/9/110	PASSO FISSO	SELCO	LAM1520022	
350	4,4	72	75	3,2	10°	4/15/105 + 3/7/100	PASSO FISSO		LAM1520023	
350	4,4	72	80	3,2	10°	2/14/110 +2/7/110+4/19/120+2/9/130	PASSO FISSO		LAM1520024	
350	4,6	72	80	3,2	10°	2/14/110 +2/7/110+4/19/120+2/9/131	PASSO FISSO		LAM1520025	
355	4,4	72	30	3,2	10°	2/7/42 +2/9,5/45,5 +2/10/60	PASSO FISSO		LAM1520026	



DIMENSIONI DIMENSIONS						TIPO DI MACCHINA	ARTICOLI	ITEMS	PREZZI €	
D	B	Z	DB	A	α °	FT / PH	PASSO	MACHINE TYPES	COD / SKU	PRICE €
DIAMETER	THICN.	T. TEETH	HOLE DIAM.	THICN.	C. ANGLE	PHIN HOLE	TYPE			
355	4,4	72	65	3,2	10°	2/9/110	PASSO FISSO	SELCO	LAM1520027	
355	4,4	72	75	3,2	10°	4/15/105 + 3/7/100	PASSO FISSO		LAM1520028	
355	4,4	72	80	3,2	10°	2/14/110 + 2/7/110 + 4/19/120 + 2/9/130	PASSO FISSO		LAM1520029	
360	4,4	72	50	3,2	10°	4/13/80	PASSO FISSO	GIBEN	LAM1520030	
360	4,6	72	65	3,2	10°	2/9/110	PASSO FISSO	SELCO	LAM1520031	
370	4,4	72	30	3,2	10°		PASSO FISSO	SCHELLING	LAM1520032	
380	4,4	72	50	3,2	10°	4/13/80	PASSO FISSO	GIBEN	LAM1520033	
380	4,4	72	60	3,2	10°	2/14/100	PASSO FISSO	HOLZMA	LAM1520034	
380	4,4	72	75	3,2	10°	4/15/105 + 3/7/100	PASSO FISSO		LAM1520035	
380	4,4	72	80	3,2	10°	2/14/110 + 2/7/110 + 4/19/120 + 2/9/130	PASSO FISSO		LAM1520036	
380	4,8	72	60	3,5	10°	2/14/100	PASSO FISSO	HOLZMA	LAM1520037	
380	4,8	84	60	3,5	10°	2/14/100	PASSO FISSO	HOLZMA	LAM1520038	
400	4,25	72	30	3,2	10°	02/10/1960	PASSO FISSO		LAM1520039	
400	4,4	60	30	3,2	10°	02/10/1960	PASSO FISSO		LAM1520040	
400	4,4	60	75	3,2	10°	4/15/105	PASSO FISSO	GIBEN - HOMAG	LAM1520041	
400	4,4	60	80	3,2	10°	2/14/110 + 2/7/110 + 4/19/120 + 2/9/130	PASSO FISSO		LAM1520042	
400	4,4	72	30	3,2	10°	02/10/1960	PASSO FISSO		LAM1520043	
400	4,4	72	60	3,2	10°		PASSO FISSO	ANTHON	LAM1520044	
400	4,4	72	65	3,2	10°		PASSO FISSO	SELCO	LAM1520045	
400	4,4	72	75	3,2	10°	4/15/105	PASSO FISSO	GIBEN - HOMAG	LAM1520046	
400	4,4	72	80	3,2	10°	2/14/110 + 2/7/110 + 4/19/120 + 2/9/130	PASSO FISSO		LAM1520047	
400	4,6	72	80	3,2	10°	2/14/110 + 2/7/110 + 4/19/120 + 2/9/130	PASSO FISSO		LAM1520048	
400	4,8	72	60	3,5	10°	2/14/125	PASSO FISSO	HOLZMA	LAM1520049	
420	4,4	72	80	3,2	10°	2/14/110 + 2/7/110 + 4/19/120 + 2/9/130	PASSO FISSO		LAM1520050	
420	4,8	72	60	3,5	10°	2/14/125	PASSO FISSO	HOLZMA	LAM1520051	
430	4,4	72	30	3,2	10°	22191	PASSO FISSO		LAM1520052	
430	4,4	72	60	3,2	10°		PASSO FISSO	ANTHON	LAM1520053	
430	4,4	72	65	3,2	10°		PASSO FISSO	SELCO	LAM1520054	
430	4,4	72	75	3,2	10°	4/15/105	PASSO FISSO	GIBEN	LAM1520055	
430	4,4	72	80	3,2	10°	2/14/110 + 2/7/110 + 4/19/120 + 2/9/130	PASSO FISSO		LAM1520056	
430	4,4	96	75	3,2	10°	4/15/105	PASSO FISSO	GIBEN	LAM1520057	
430	4,6	72	80	3,2	10°	2/14/110 + 2/7/110 + 4/19/120 + 2/9/130	PASSO FISSO		LAM1520058	
430	4,8	72	70	3,5	10°		PASSO FISSO	SELCO	LAM1520059	
450	4,4	72	30	3,2	10°	22161	PASSO FISSO	SCHELLING	LAM1520060	
450	4,4	72	60	3,2	10°	2/14/125	PASSO FISSO	ANTHON - HOLZMA	LAM1520061	
450	4,4	72	75	3,2	10°		PASSO FISSO	MACMAZZA	LAM1520062	
450	4,4	72	80	3,2	10°	2/14/110 + 2/7/110 + 4/19/120 + 2/9/130	PASSO FISSO		LAM1520063	
450	4,6	72	80	3,2	10°	2/14/110 + 2/7/110 + 4/19/120 + 2/9/130	PASSO FISSO		LAM1520064	
450	4,8	72	60	3,5	10°	2/14/125	PASSO FISSO	HOLZMA	LAM1520065	
450	4,8	72	80	3,5	10°	2/14/110 + 2/7/110 + 4/19/120 + 2/9/130	PASSO FISSO		LAM1520066	
460	4,4	72	30	3,2	10°	2/13/94	PASSO FISSO	SCHELLING	LAM1520067	
470	4,4	72	70	3,2	10°		PASSO FISSO	SELCO	LAM1520068	
470	4,4	72	75	3,2	10°	4/15/105	PASSO FISSO	GIBEN	LAM1520069	
470	4,4	96	75	3,2	10°	4/15/105	PASSO FISSO	GIBEN	LAM1520070	
480	4,4	72	30	3,2	10°	22191	PASSO FISSO	SCHELLING	LAM1520071	
480	4,8	72	60	3,5	10°	2/11/115	PASSO FISSO	HOLZMA	LAM1520072	
480	4,8	72®	80	3,5	10°	2/9/130 + 4/19/120	PASSO FISSO	SELCO	LAM1520073	
480	5,2	72	80	3,5	10°	2/9/130 + 4/19/120	PASSO FISSO	SELCO	LAM1520074	
500	4,6	72	30	3,2	10°		PASSO FISSO	SCHELLING	LAM1520075	
500	4,8	60	60	3,5	10°	2/19/120 + 2/11/115	PASSO FISSO	HOLZMA	LAM1520076	
500	4,8	72	60	3,5	10°	2/19/120 + 2/11/115	PASSO FISSO	HOLZMA	LAM1520077	
520	4,8	60	60	3,5	10°	2/19/120 + 2/11/115	PASSO FISSO	HOLZMA	LAM1520078	
520	4,8	72	30	3,5	10°		PASSO FISSO	SCHELLING	LAM1520079	

TOPCUT 9 LAM1521

HW

LAMA INCISORE REGOLABILE IN HW
HW ADJUSTABLE SCORING BLADE

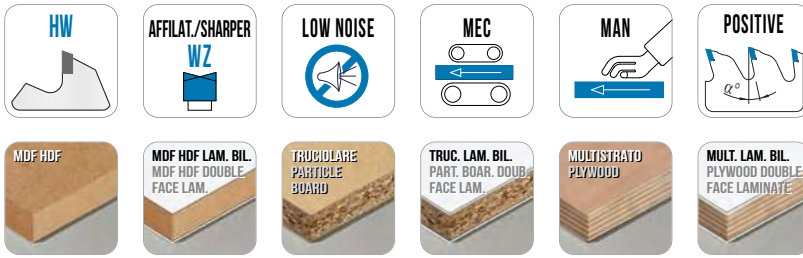

Incisore regolabile in HW per l'incisione di pannelli bilaminati applicabile su macchine sezionatrici orizzontali.

HW adjustable scoring blade suitable on sliding table machines.

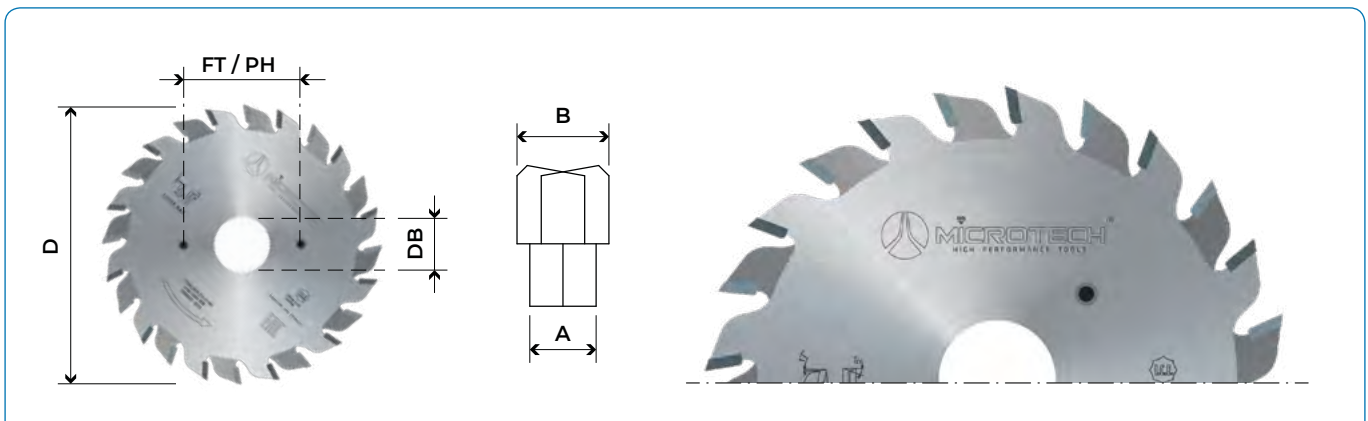

DIMENSIONI DIMENSIONS						TIPO DI MACCHINA	ARTICOLI	ITEMS	PREZZI €
D	B	Z	DB	A	α°	FT / PH	MACHINE TYPES	COD / SKU	PRICE €
DIAMETER	THICKNESS	TOTAL TEETH	HOLE DIAMETER	THICKNESS	CUT. ANGLE	PHIN HOLE			
70	2,8/3,6	8+8	20	2,2+2,2	5°			LAM1521001	
80	2,8/3,6	10+10	20	2,2+2,2	5°			LAM1521002	
100	2,8/3,6	10+10	20	2,2+2,2	5°			LAM1521003	
100	2,8/3,6	10+10	22	2,2+2,2	5°			LAM1521004	
100	3,1/3,9	10+10	20	2,2+2,2	5°			LAM1521005	
100	3,1/3,9	10+10	22	2,2+2,2	5°			LAM1521006	
120	2,8/3,6	12+12	20	2,2+2,2	5°			LAM1521007	
120	2,8/3,6	12+12	22	2,2+2,2	5°			LAM1521008	
120	3,1/3,9	12+12	20	2,2+2,2	5°			LAM1521009	
120	3,1/3,9	12+12	22	2,2+2,2	5°			LAM1521010	
125	2,8/3,6	12+12	20	2,2+2,2	5°			LAM1521011	
125	2,8/3,6	12+12	22	2,2+2,2	5°			LAM1521012	
125	3,1/3,9	12+12	20	2,2+2,2	5°			LAM1521013	
125	3,1/3,9	12+12	22	2,2+2,2	5°			LAM1521014	
125	3,1/3,9	12+12	30	2,2+2,2	5°			LAM1521015	
125	4,0/4,8	20+20	45	2,2+2,2	5°		GIBEN	LAM1521016	
160	2,8/3,6	18+18	30	2,2+2,2	5°			LAM1521017	
160	3,5/4,3	18+18	30	2,2+2,2	5°			LAM1521018	
180	2,8/3,6	18+18	30	2,2+2,2	5°			LAM1521019	
180	3,5/4,3	18+18	30	2,2+2,2	5°			LAM1521020	
180	4,4/5,5	18+18	45	2,2+2,2	5°		HOLZMA	LAM1521021	
180	4,8/5,6	28+28	55+3	2,2+2,2	5°		GABBIANI	LAM1521022	
200	4,3/5,2	30+30	20	2,2+2,2	5°		SCM	LAM1521023	
300	4,3/5,5	32+32	50+3	1,8+1,8	5°		GIBEN	LAM1521024	
340	4,4/5,6	32+32	45	2,5+2,5	5°		HOLZMA	LAM1521025	

GROOVINGCUT 1 LAM1522

HW

LAMA CIRCOLARE IN HW PER CANALI

HW GROOVING BLADE



Lama circolare per canali in HW.

HW grooving blade.

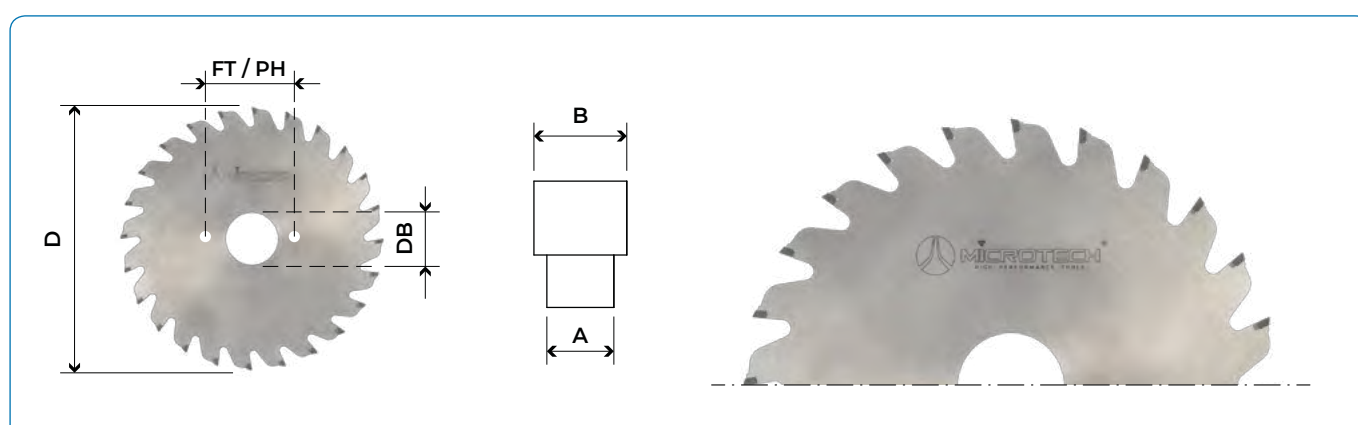

DIMENSIONI DIMENSIONS						ARTICOLI ITEMS	PREZZI €	
D	B	Z	DB	A	α °	FT / PH	COD / SKU	PRICE €
DIAMETER	THICKNESS	TOTAL TEETH	HOLE DIAMETER	THICKNESS	CUT. ANGLE	PHIN HOLE		
125	1,5	12	30	1,2	10°		LAM1522001	
125	1,8	12	30	1,2	10°		LAM1522002	
125	2	12	30	1,4	10°		LAM1522003	
125	2,5	12	30	1,6	10°		LAM1522004	
125	3	12	30	2	10°		LAM1522005	
125	3,5	12	30	2,5	10°		LAM1522006	
125	4	12	30	2,8	10°		LAM1522007	
125	4,5	12	30	3,2	10°		LAM1522008	
125	5	12	30	4	10°		LAM1522009	
125	6	12	30	4	10°		LAM1522010	
125	7	12	30	6	10°		LAM1522011	
125	8	12	30	6	10°		LAM1522012	
125	9	12	30	6	10°		LAM1522013	
125	10	12	30	6	10°		LAM1522014	
150	1,5	18	30	1,2	10°		LAM1522015	
150	1,8	18	30	1,2	10°		LAM1522016	
150	2	18	30	1,4	10°		LAM1522017	
150	2,5	18	30	1,6	10°		LAM1522018	
150	3	18	30	2	10°		LAM1522019	
150	3,5	18	30	2,5	10°		LAM1522020	
150	4	18	30	2,8	10°		LAM1522021	
150	5	18	30	4	10°		LAM1522022	
150	6	18	30	4	10°		LAM1522023	
150	7	18	30	6	10°		LAM1522024	
150	8	18	30	6	10°		LAM1522025	
150	9	18	30	6	10°		LAM1522026	

DIMENSIONI DIMENSIONS						ARTICOLI ITEMS	PREZZI €	
D DIAMETER	B THICKNESS	Z TOTAL TEETH	DB HOLE DIAMETER	A THICKNESS	α ° CUT. ANGLE	FT / PH PHIN HOLE	COD / SKU	PRICE €
150	10	18	30	6	10°		LAM1522027	
180	2	24	30	1,4	10°		LAM1522028	
180	2,5	24	30	1,6	10°		LAM1522029	
180	3	24	30	2	10°		LAM1522030	
180	3,5	24	30	2,5	10°		LAM1522031	
180	4	24	30	2,8	10°		LAM1522032	
180	5	24	30	4	10°		LAM1522033	
180	6	24	30	4	10°		LAM1522034	
180	7	24	30	6	10°		LAM1522035	
180	8	24	30	6	10°		LAM1522036	
180	9	24	30	6	10°		LAM1522037	
180	10	24	30	6	10°		LAM1522038	
180	2	24	35	1,4	10°		LAM1522039	
180	2,5	24	35	1,6	10°		LAM1522040	
180	3	24	35	2	10°		LAM1522041	
180	3,5	24	35	2,5	10°		LAM1522042	
180	4	24	35	2,8	10°		LAM1522043	
180	5	24	35	4	10°		LAM1522044	
180	6	24	35	4	10°		LAM1522045	
180	7	24	35	6	10°		LAM1522046	
180	8	24	35	6	10°		LAM1522047	
180	9	24	35	6	10°		LAM1522048	
180	10	24	35	6	10°		LAM1522049	
200	3	32	30	2	10°		LAM1522050	
200	4	32	30	2,8	10°		LAM1522051	
200	5	32	30	4	10°		LAM1522052	
200	6	32	30	4	10°		LAM1522053	
250	3	40	30	2	10°	2/7/42 +2/9,5/45,5 +2/10/60	LAM1522054	
250	4	40	30	2,8	10°	2/7/42 +2/9,5/45,5 +2/10/60	LAM1522055	
250	5	40	30	4	10°	2/7/42 +2/9,5/45,5 +2/10/60	LAM1522056	
250	6	40	30	4	10°	2/7/42 +2/9,5/45,5 +2/10/60	LAM1522057	
300	3	48	30	2	10°	2/7/42 +2/9,5/45,5 +2/10/60	LAM1522058	
300	4	48	30	2,8	10°	2/7/42 +2/9,5/45,5 +2/10/60	LAM1522059	
300	5	48	30	4	10°	2/7/42 +2/9,5/45,5 +2/10/60	LAM1522060	
300	6	48	30	4	10°	2/7/42 +2/9,5/45,5 +2/10/60	LAM1522061	

TOPCUT 10 LAM1523

HW

LAMA CIRCOLARE IN HW CON TAGLIENTI NEGATIVI PER METALLI NON FERROSI

HW SAW BLADE WITH NEGATIVE CUTTING SUITABLE FOR LIGHT METAL

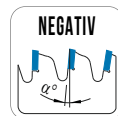
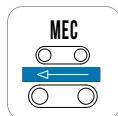

Lama circolare in HW con tagliente negativo per lavorazione metalli leggeri come alluminio.

HW saw blade with negative cutting suitable for light metal like aluminium.

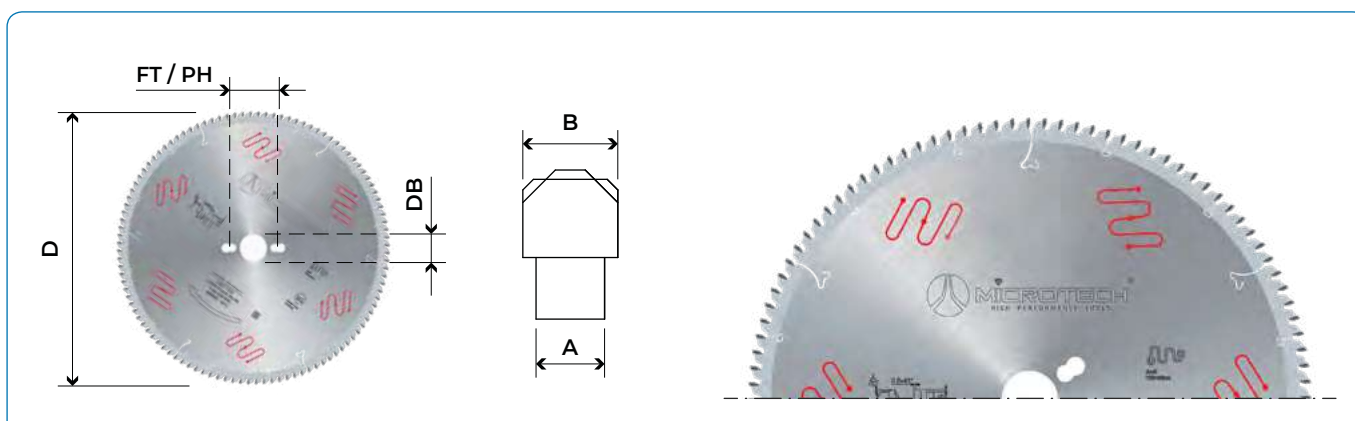

DIMENSIONI DIMENSIONS						ARTICOLI ITEMS	PREZZI €	
D DIAMETER	B THICKNESS	Z TOTAL TEETH	DB HOLE DIAMETER	A THICKNESS	α° CUT. ANGLE	FT / PH PHIN HOLE	COD / SKU	PRICE €
200	3,2	64	20	2,5	10°-		LAM1523001	
250	3,4	60	30	2,6	10°-	2/11/63	LAM1523002	
250	3,4	60	32	2,6	10°-	2/11/63	LAM1523003	
250	3,4	80	30	2,6	10°-	2/11/63	LAM1523004	
250	3,4	80	32	2,6	10°-	2/11/63	LAM1523005	
275	3,4	84	30	2,6	10°-	2/11/63	LAM1523006	
275	3,4	84	32	2,6	10°-	2/11/63	LAM1523007	
300	3,4	72	30	2,6	10°-	2/11/63	LAM1523008	
300	3,4	72	32	2,6	10°-	2/11/63	LAM1523009	
300	3,4	84	30	2,6	10°-	2/11/63	LAM1523010	
300	3,4	84	32	2,6	10°-	2/11/63	LAM1523011	
300	3,4	96	30	2,6	10°-	2/11/63	LAM1523012	
300	3,4	96	32	2,6	10°-	2/11/63	LAM1523013	
320	3,4	96	30	2,6	10°-	2/11/63	LAM1523014	
330	3,4	96	30	2,6	10°-	2/11/63	LAM1523015	
350	3,4	84	30	2,6	10°-	2/11/63	LAM1523016	
350	3,4	84	32	2,6	10°-	2/11/63	LAM1523017	
350	3,4	96	30	2,6	10°-	2/11/63	LAM1523018	
350	3,4	96	32	2,6	10°-	2/11/63	LAM1523019	
350	3,4	108	30	2,6	10°-	2/11/63	LAM1523020	
350	3,4	108	32	2,6	10°-	2/11/63	LAM1523021	
370	3,8	96	30	3	10°-	2/11/63	LAM1523022	
380	3,8	96	30	3	10°-	2/11/63	LAM1523023	
400	4	96	30	3,2	10°-	2/11/63	LAM1523024	
400	4	96	32	3,2	10°-	2/11/63	LAM1523025	
400	4	108	30	3,2	10°-	2/11/63	LAM1523026	



DIMENSIONI DIMENSIONS							ARTICOLI ITEMS	PREZZI €
D DIAMETER	B THICKNESS	Z TOTAL TEETH	DB HOLE DIAMETER	A THICKNESS	α° CUT. ANGLE	FT / PH PHIN HOLE	COD / SKU	PRICE €
400	4	108	32	3,2	10°-	2/11/63	LAM1523027	
400	4	120	30	3,2	10°-	2/11/63	LAM1523028	
400	4	120	32	3,2	10°-	2/11/63	LAM1523029	
420	4	96	30	3,2	10°-	2/11/63	LAM1523030	
430	4	96	30	3,2	10°-	2/11/63	LAM1523031	
450	4	96	30	3,2	10°-	2/11/63	LAM1523032	
450	4	96	32	3,2	10°-	2/11/63	LAM1523033	
450	4	108	30	3,2	10°-	2/11/63	LAM1523034	
450	4	108	32	3,2	10°-	2/11/63	LAM1523035	
450	4	128	30	3,2	10°-	2/11/63	LAM1523036	
450	4	128	32	3,2	10°-	2/11/63	LAM1523037	
450	4	140	30	3,2	10°-	2/11/63	LAM1523038	
500	4,6	120	30	3,6	10°-	2/11/63	LAM1523039	
500	4,6	120	32	3,6	10°-	2/11/63	LAM1523040	
500	4,6	140	30	3,6	10°-	2/11/63	LAM1523041	
500	4,6	156	30	3,6	10°-	2/11/63	LAM1523042	
550	4,6	140	30	3,6	10°-	2/11/63	LAM1523043	
550	4,6	172	30	3,6	10°-	2/11/63	LAM1523044	
600	4,6	140	30	3,6	10°-	2/11/63	LAM1523045	
600	4,6	186	30	3,6	10°-	2/11/63	LAM1523046	
650	5	160	30	4	10°-	2/11/63	LAM1523047	
700	5	160	30	4	10°-	2/11/63	LAM1523048	

TOPCUT 11 LAM1524

HW

LAMA CIRCOLARE IN HW CON TAGLIENTI POSITIVI PER METALLI NON FERROSI

HW SAW BLADE WITH POSITIVE CUTTING SUITABLE FOR LIGHT METAL

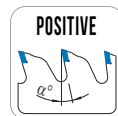
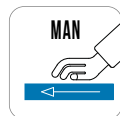
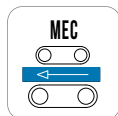

Lama circolare in HW con tagliente positivo per lavorazione metalli leggeri come alluminio.

HW saw blade with positive cutting suitable for light metal like aluminium.

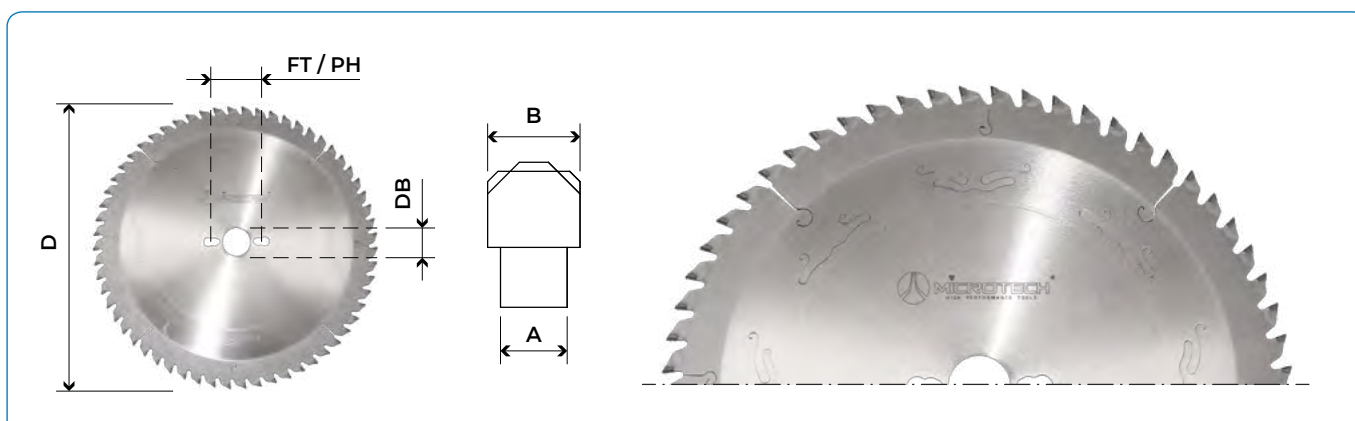

DIMENSIONI DIMENSIONS						ARTICOLI ITEMS	PREZZI €	
D DIAMETER	B THICKNESS	Z TOTAL TEETH	DB HOLE DIAMETER	A THICKNESS	α ° CUT. ANGLE	FT / PH PHIN HOLE	COD / SKU	PRICE €
200	3,2	48	20	2,5	10°		LAM1524001	
200	3,2	64	20	2,5	10°		LAM1524002	
250	3,4	60	30	2,6	10°	02/11/1963	LAM1524003	
250	3,4	60	32	2,6	10°	02/11/1963	LAM1524004	
250	3,4	80	30	2,6	10°	02/11/1963	LAM1524005	
250	3,4	80	32	2,6	10°	02/11/1963	LAM1524006	
275	3,4	84	30	2,6	10°	02/11/1963	LAM1524007	
275	3,4	84	32	2,6	10°	02/11/1963	LAM1524008	
300	3,4	72	30	2,6	10°	02/11/1963	LAM1524009	
300	3,4	72	32	2,6	10°	02/11/1963	LAM1524010	
300	3,4	84	30	2,6	10°	02/11/1963	LAM1524011	
300	3,4	84	32	2,6	10°	02/11/1963	LAM1524012	
300	3,4	96	30	2,6	10°	02/11/1963	LAM1524013	
300	3,4	96	32	2,6	10°	02/11/1963	LAM1524014	
320	3,4	96	30	2,6	10°	02/11/1963	LAM1524015	
330	3,4	96	30	2,6	10°	02/11/1963	LAM1524016	
350	3,4	84	30	2,6	10°	02/11/1963	LAM1524017	
350	3,4	84	32	2,6	10°	02/11/1963	LAM1524018	
350	3,4	96	30	2,6	10°	02/11/1963	LAM1524019	
350	3,4	96	32	2,6	10°	02/11/1963	LAM1524020	
350	3,4	108	30	2,6	10°	02/11/1963	LAM1524021	
350	3,4	108	32	2,6	10°	02/11/1963	LAM1524022	
370	3,8	96	30	3	10°	02/11/1963	LAM1524023	
380	3,8	96	30	3	10°	02/11/1963	LAM1524024	
400	4	96	30	3,2	10°	02/11/1963	LAM1524025	
400	4	96	32	3,2	10°	02/11/1963	LAM1524026	



DIMENSIONI DIMENSIONS							ARTICOLI ITEMS	PREZZI €
D DIAMETER	B THICKNESS	Z TOTAL TEETH	DB HOLE DIAMETER	A THICKNESS	α ° CUT. ANGLE	FT / PH PHIN HOLE	COD / SKU	PRICE €
400	4	108	30	3,2	10°	02/11/1963	LAM1524027	
400	4	108	32	3,2	10°	02/11/1963	LAM1524028	
400	4	120	30	3,2	10°	02/11/1963	LAM1524029	
400	4	120	32	3,2	10°	02/11/1963	LAM1524030	
420	4	96	30	3,2	10°	02/11/1963	LAM1524031	
430	4	96	30	3,2	10°	02/11/1963	LAM1524032	
450	4	96	30	3,2	10°	02/11/1963	LAM1524033	
450	4	96	32	3,2	10°	02/11/1963	LAM1524034	
450	4	108	30	3,2	10°	02/11/1963	LAM1524035	
450	4	108	32	3,2	10°	02/11/1963	LAM1524036	
450	4	128	30	3,2	10°	02/11/1963	LAM1524037	
450	4	128	32	3,2	10°	02/11/1963	LAM1524038	
450	4	140	30	3,2	10°	02/11/1963	LAM1524039	
500	4,6	120	30	3,6	10°	02/11/1963	LAM1524040	
500	4,6	120	32	3,6	10°	02/11/1963	LAM1524041	
500	4,6	140	30	3,6	10°	02/11/1963	LAM1524042	
550	4,6	120	30	3,6	10°	02/11/1963	LAM1524043	
550	4,6	140	30	3,6	10°	02/11/1963	LAM1524044	
600	4,6	120	30	3,6	10°	02/11/1963	LAM1524045	
600	4,6	140	30	3,6	10°	02/11/1963	LAM1524046	
650	5	140	30	4	10°	02/11/1963	LAM1524047	
700	5	140	30	4	10°	02/11/1963	LAM1524048	

LAMELLO 5 LAM1525



FRESA LAMELLO IN HW PER INCASTRI A BISCOTTO

LAMELLO HW SAW BLADE FOR BISCUIT JOINTING SYSTEM FOR BISCUIT JOINTING SYSTEM



Fresa in HW Lamello per incastri da utilizzare su macchine CNC e su fresatrice manuale Zeta P2 Clamex P-System. La giunzione e' perfetta per la produzione di mobili in serie o pezzi unici, nel rifacimento degli interni e per l'allestimento di negozio o stand per fiere.

HW saw blade for LAMELLO SYSTEM.

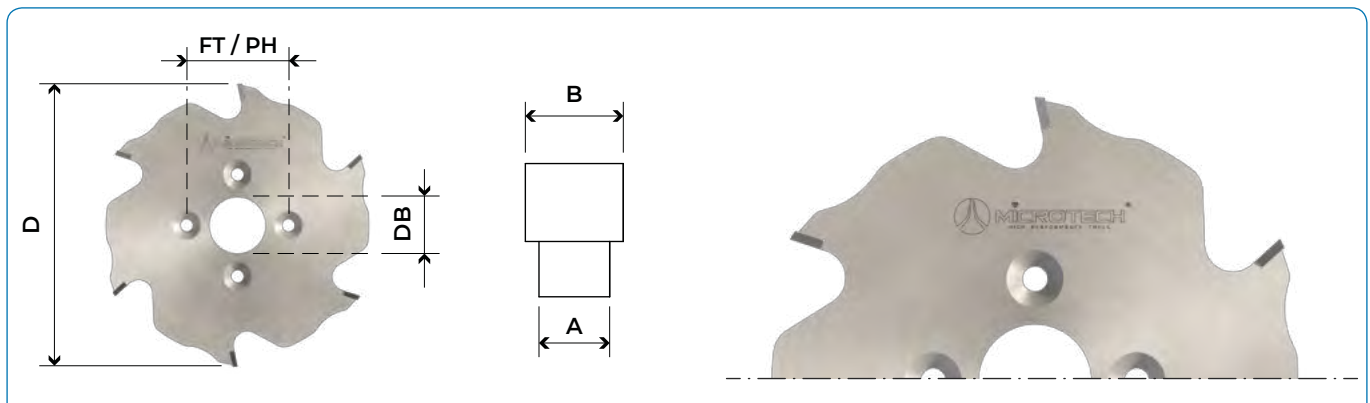

DIMENSIONI DIMENSIONS						ARTICOLI ITEMS	PREZZI €	
D	B	Z	DB	A	α °	FT / PH	COD / SKU	PRICE €
DIAMETER	THICKNESS	TOTAL TEETH	HOLE DIAMETER	THICKNESS	CUTTING ANGLE	PHIN HOLE		
100	3,96	6	22	3	10°	N4 / 4,5 / INT 35,9 SVAST. ANTIORARIA	LAM1525001	
100	3,96	8	22	3	10°	N4 / 4,5 / INT 35,9 SVAST. ANTIORARIA	LAM1525002	

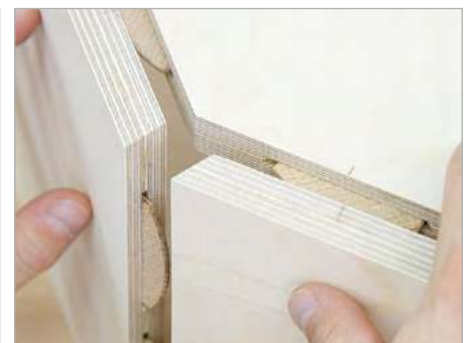



TRUCIOLATORI - SQUADRATRICE

HOGGERS - SQUARING



TRCP TRC6001

TRUCIOLATORE IN DIAMANTE
COMPATTO POSITIVO

DP COMPACT
POSITIVE HOGGER

41
PAG.



TRR TRC6003

TRUCIOLATORE IN DIAMANTE
COMPATTO A RAGGIO COSTANTE

DP COMPACT
RADIUS HOGGER

43
PAG.



TRCN TRC6002

TRUCIOLATORE IN DIAMANTE
COMPATTO NEGATIVO

DP COMPACT
NEGATIVE HOGGER

42
PAG.



TRCG TRC6004

TRUCIOLATORE IN DIAMANTE
NEGATIVO GEOMETRIA A GRADINO

DP NEGATIVE HOGGER
STEP GEOMETRY

44
PAG.

TRCP TRC600 1

TRUCIOLATORE IN DIAMANTE COMPATTO POSITIVO

DP COMPACT POSITIVE HOGGER

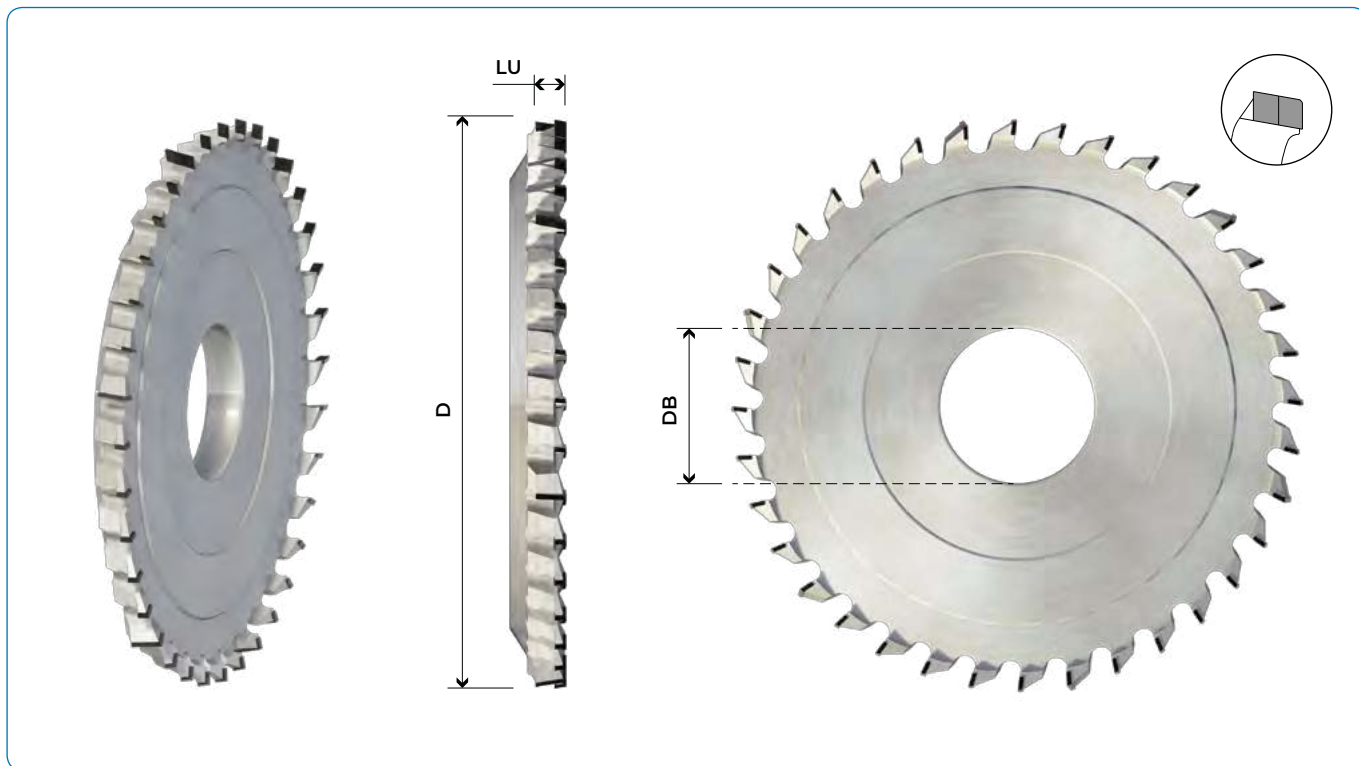
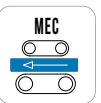

Truciolatore compatto in diamante riaffilabile angolo di taglio positivo, altezza PCD 6 mm, adatto per lavorazioni di pannelli truciolari, nobilitati, laminati, M.D.F., utilizzabile su macchine squadratrici e squadrabordatrici.

Re-sharpening compact hogger in diamond with positive cut angle, height PCD 6 mm, suitable for working on chipboard panels, laminated, M.D.F., it can be used on squaring machines and squaring-edging machines.

DIMENSIONI DIMENSIONS					ARTICOLI ITEMS		PREZZI €					
D DIAM.	LU U. LENGHT	DB HOLE DIAM.	Z TOT TOT. TEETH	Z EFF ACTUAL TEETH	FORI AGG. ADJ. BORE	ANG. Ass.	H POS	β° AXIAL ANGLE	MT/MIN FEED RATE	SX / LH CODICE / SKU	DX / RH CODICE / SKU	PRICE €
250	12	60	24	20+4	S-SYSTEM160	7°	6	10°	18-25	TRC6001001	TRC6001002	
250	12	60	30	24+6	S-SYSTEM160	7°	6	10°	25-32	TRC6001003	TRC6001004	
250	12	60	36	30+6	S-SYSTEM160	7°	6	10°	30-40	TRC6001005	TRC6001006	
250	12	60	42	36+6	S-SYSTEM160	7°	6	10°	35-45	TRC6001007	TRC6001008	
250	12	60	48	42+6	S-SYSTEM160	7°	6	10°	40-50	TRC6001009	TRC6001010	
250	12	60	54	48+6	S-SYSTEM160	7°	6	10°	50-60	TRC6001011	TRC6001012	
250	12	80	24	20+4	S-SYSTEM192	7°	6	10°	18-25	TRC6001013	TRC6001014	
250	12	80	30	24+6	S-SYSTEM192	7°	6	10°	25-32	TRC6001015	TRC6001016	
250	12	80	36	30+6	S-SYSTEM192	7°	6	10°	30-40	TRC6001017	TRC6001018	
250	12	80	42	36+6	S-SYSTEM192	7°	6	10°	35-45	TRC6001019	TRC6001020	
250	12	80	48	42+6	S-SYSTEM192	7°	6	10°	40-50	TRC6001021	TRC6001022	
250	12	80	54	48+6	S-SYSTEM192	7°	6	10°	50-60	TRC6001023	TRC6001024	
250	12	80+	24	20+4	4(9/100)	7°	6	10°	18-25	TRC6001025	TRC6001026	
250	12	80+	30	24+6	4(9/100)	7°	6	10°	25-32	TRC6001027	TRC6001028	
250	12	80+	36	30+6	4(9/100)	7°	6	10°	30-40	TRC6001029	TRC6001030	
250	12	80+	42	36+6	4(9/100)	7°	6	10°	35-45	TRC6001031	TRC6001032	
250	12	80+	48	42+6	4(9/100)	7°	6	10°	40-50	TRC6001033	TRC6001034	
250	12	80+	54	48+6	4(9/100)	7°	6	10°	50-60	TRC6001035	TRC6001036	

TRCN TRC6002

TRUCIOLATORE IN DIAMANTE COMPATTO NEGATIVO

DP COMPACT NEGATIVE HOGGER

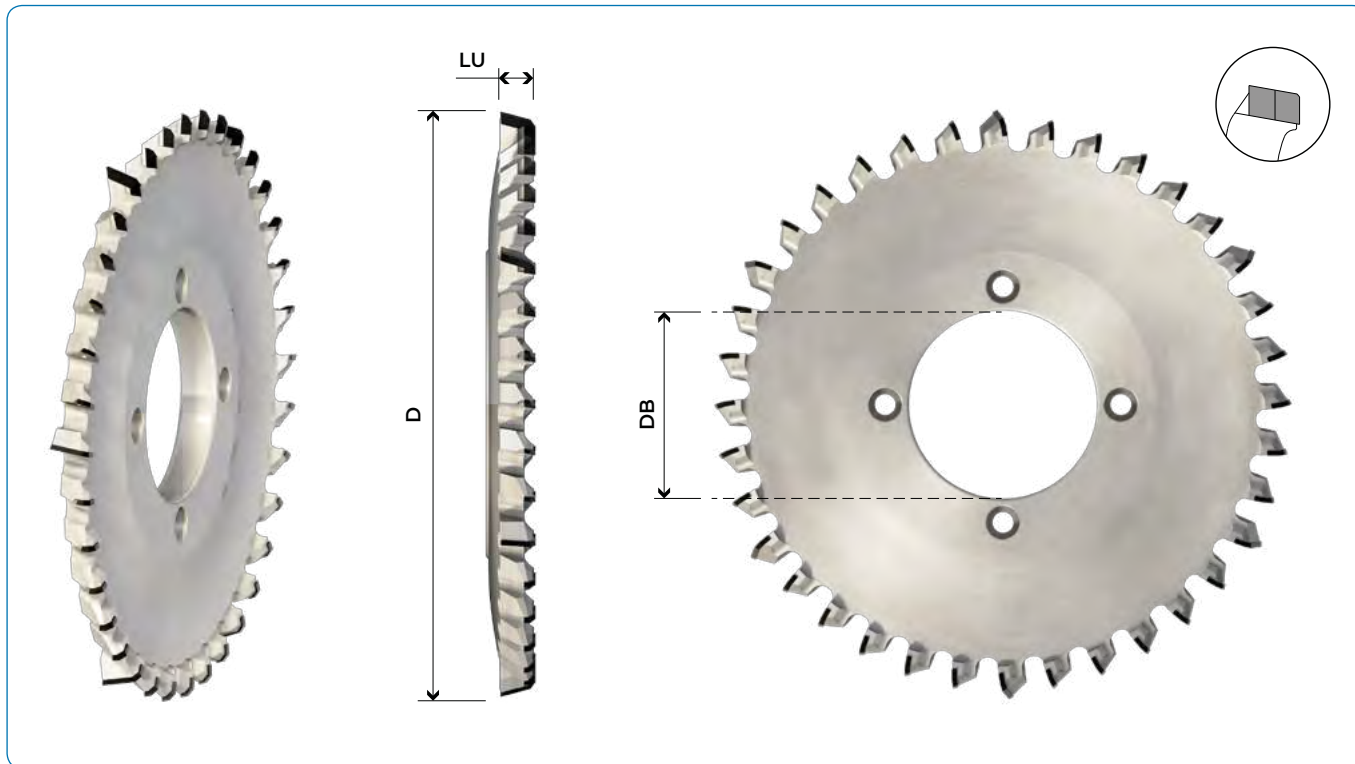

Truciolatore compatto in diamante riaffilabile angolo di taglio negativo, altezza PCD 6 mm, adatto per lavorazioni di pannelli truciolari, nobilitati, laminati, M.D.F., utilizzabile su macchine squadratrici e squadrabordatrici.

Re-sharpening compact hogger in diamond with negative cut angle, height PCD 6 mm, suitable for working on chipboard panels, laminated, M.D.F., it can be used on squaring machines and squaring-edging machines.

DIMENSIONI DIMENSIONS									ARTICOLI ITEMS		PREZZI €	
D	LU	DB	Z TOT	Z EFF	FORI AGG.	ANG.	H	β°	MT/MIN	SX / LH	DX / RH	PRICE €
DIAM.	U. LENGHT	HOLE DIAM.	TOT. TEETH	ACTUAL TEETH	ADD. BORE	Ass.	POS	AXIAL ANGLE	FEED RATE	CODICE / SKU	CODICE / SKU	
250	12	60	24	20+4	S-SYSTEM160	7°	6	-10°	18-25	TRC6002001	TRC6002002	
250	12	60	30	24+6	S-SYSTEM160	7°	6	-10°	25-32	TRC6002003	TRC6002004	
250	12	60	36	30+6	S-SYSTEM160	7°	6	-10°	30-40	TRC6002005	TRC6002006	
250	12	60	42	36+6	S-SYSTEM160	7°	6	-10°	35-45	TRC6002007	TRC6002008	
250	12	60	48	42+6	S-SYSTEM160	7°	6	-10°	40-50	TRC6002009	TRC6002010	
250	12	60	54	48+6	S-SYSTEM160	7°	6	-10°	50-60	TRC6002011	TRC6002012	
250	12	80	24	20+4	S-SYSTEM192	7°	6	-10°	18-25	TRC6002013	TRC6002014	
250	12	80	30	24+6	S-SYSTEM192	7°	6	-10°	25-32	TRC6002015	TRC6002016	
250	12	80	36	30+6	S-SYSTEM192	7°	6	-10°	30-40	TRC6002017	TRC6002018	
250	12	80	42	36+6	S-SYSTEM192	7°	6	-10°	35-45	TRC6002019	TRC6002020	
250	12	80	48	42+6	S-SYSTEM192	7°	6	-10°	40-50	TRC6002021	TRC6002022	
250	12	80	54	48+6	S-SYSTEM192	7°	6	-10°	50-60	TRC6002023	TRC6002024	
250	12	80+	24	20+4	4(9/100)	7°	6	-10°	18-25	TRC6002025	TRC6002026	
250	12	80+	30	24+6	4(9/100)	7°	6	-10°	25-32	TRC6002027	TRC6002028	
250	12	80+	36	30+6	4(9/100)	7°	6	-10°	30-40	TRC6002029	TRC6002030	
250	12	80+	42	36+6	4(9/100)	7°	6	-10°	35-45	TRC6002031	TRC6002032	
250	12	80+	48	42+6	4(9/100)	7°	6	-10°	40-50	TRC6002033	TRC6002034	
250	12	80+	54	48+6	4(9/100)	7°	6	-10°	50-60	TRC6002035	TRC6002036	

TRR TRC6003

TRUCIOLATORE IN DIAMANTE COMPATTO A RAGGIO COSTANTE

DP COMPACT RADIUS HOGGER

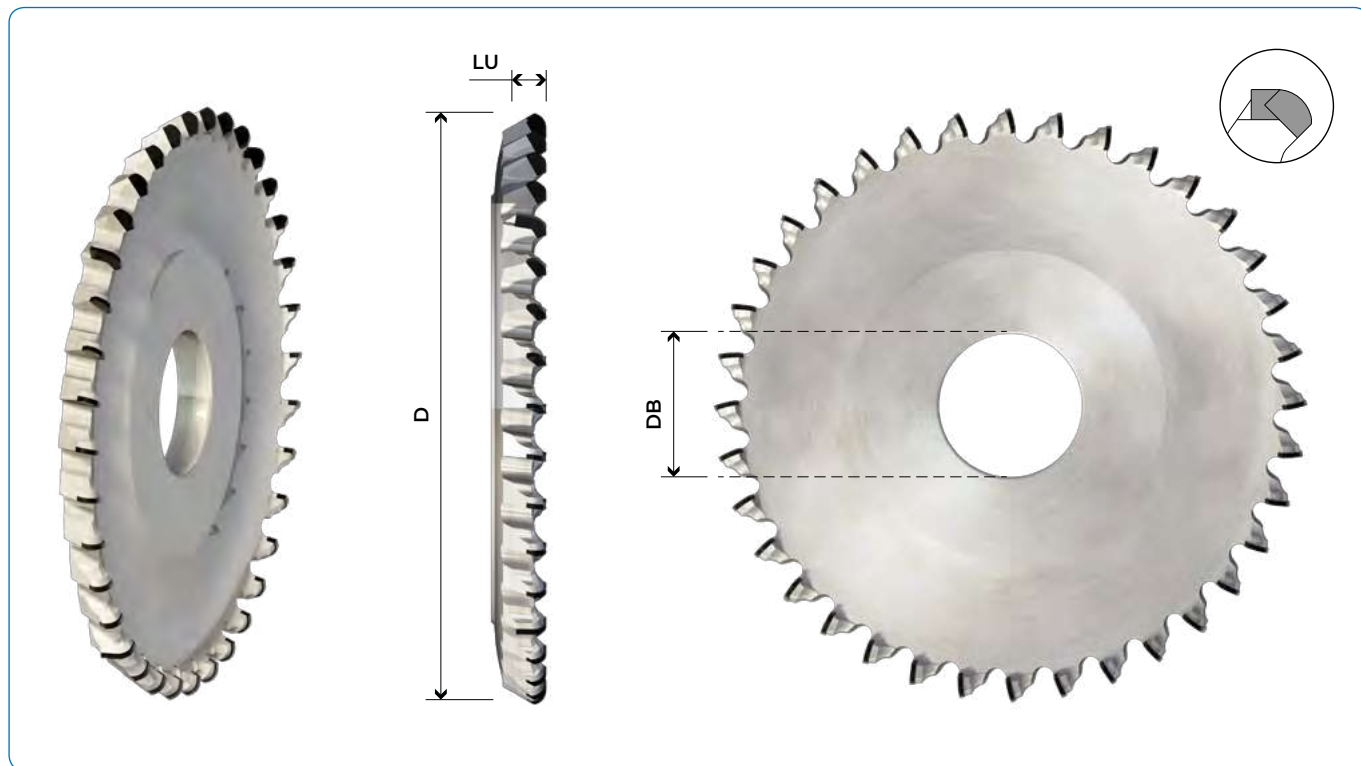
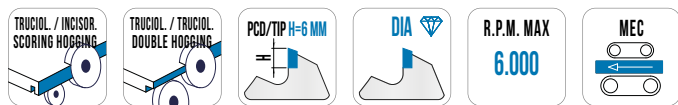

Truciolatore compatto a raggio costante in diamante riaffilabile, angolo di taglio negativo, altezza PCD 6 mm, adatto per lavorazioni di pannelli truciolari, nobilitati, laminati, M.D.F., utilizzabile su macchine squadratrici e squadrabordatrici.

Re-sharpening radius hogger in diamond with negative cut angle, height PCD 6 mm, suitable for working on chipboard panels, laminated, M.D.F., it can be used on squaring machines and squaring-edging machines.

DIMENSIONI DIMENSIONS										ARTICOLI ITEMS		PREZZI €
D DIAM.	LU U. LENGHT	DB HOLE DIAM.	Z TOT TOT. TEETH	Z EFF ACTUAL TEETH	FORI AGG. ADJ. BORE	ANG. Ass.	H POS	β° AXIAL ANGLE	MT/MIN FEED RATE	SX / LH CODICE / SKU	DX / RH CODICE / SKU	PRICE €
250	12	60	24	20+4	S-SYSTEM160	7°	6	-10°	25-30	TRC6003001	TRC6003002	760
250	12	60	30	24+6	S-SYSTEM160	7°	6	-10°	35-40	TRC6003003	TRC6003004	897
250	12	60	36	30+6	S-SYSTEM160	7°	6	-10°	40-50	TRC6003005	TRC6003006	1034
250	12	60	42	36+6	S-SYSTEM160	7°	6	-10°	45-60	TRC6003007	TRC6003008	1172
250	12	60	48	42+6	S-SYSTEM160	7°	6	-10°	60-80	TRC6003009	TRC6003010	1309
250	12	80	24	20+4	S-SYSTEM192	7°	6	-10°	25-30	TRC6003011	TRC6003012	760
250	12	80	30	24+6	S-SYSTEM192	7°	6	-10°	35-40	TRC6003013	TRC6003014	897
250	12	80	36	30+6	S-SYSTEM192	7°	6	-10°	40-50	TRC6003015	TRC6003016	1034
250	12	80	42	36+6	S-SYSTEM192	7°	6	-10°	45-60	TRC6003017	TRC6003018	1172
250	12	80	48	42+6	S-SYSTEM192	7°	6	-10°	60-80	TRC6003019	TRC6003020	1309
250	12	80+	24	20+4	4(9/100)	7°	6	-10°	25-30	TRC6003021	TRC6003022	760
250	12	80+	30	24+6	4(9/100)	7°	6	-10°	35-40	TRC6003023	TRC6003024	897
250	12	80+	36	30+6	4(9/100)	7°	6	-10°	40-50	TRC6003025	TRC6003026	1034
250	12	80+	42	36+6	4(9/100)	7°	6	-10°	45-60	TRC6003027	TRC6003028	1172
250	12	80+	48	42+6	4(9/100)	7°	6	-10°	60-80	TRC6003029	TRC6003030	1309

TRCG TRC6004

TRUCIOLATORE IN DIAMANTE NEGATIVO GEOMETRIA A GRADINO

DP NEGATIVE HOGGER STEP GEOMETRY

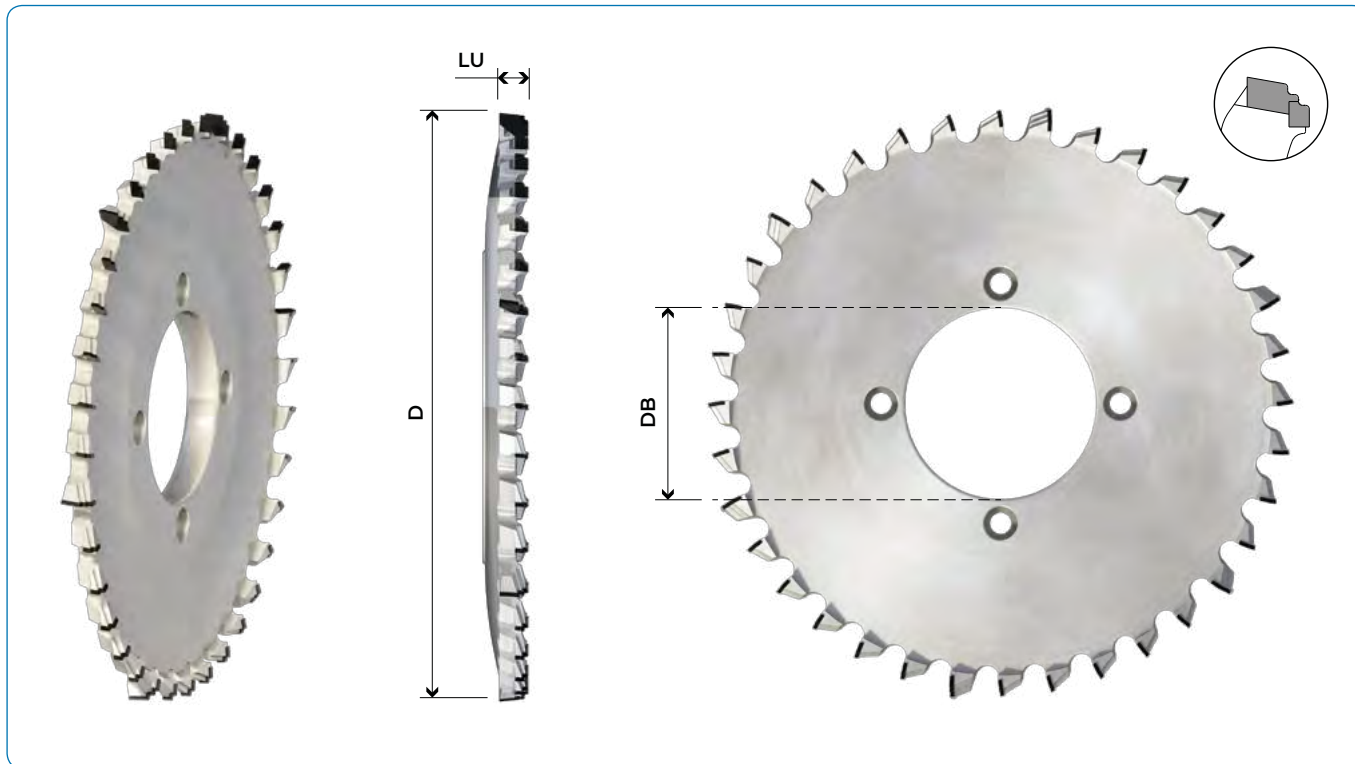

Truciolatore in diamante riaffilabile con geometria a gradino, angolo di taglio negativo, altezza PCD 6 mm, adatto per lavorazioni di pannelli truciolari, nobilitati, laminati, M.D.F., utilizzabile su macchine squadratrici e squadrabordatrici.

Re-sharpening hogger in diamond step design, with negative cut angle, height PCD 6 mm, suitable for working on chipboard panels, laminated, M.D.F., it can be used on squaring machines and squaring-edging machines.

DIMENSIONI DIMENSIONS										ARTICOLI ITEMS		PREZZI €
D	LU	DB	Z TOT	Z EFF	FORI AGG.	ANG.	H	β°	MT/MIN	SX / LH	DX / RH	PRICE €
DIAM.	U. LENGHT	HOLE DIAM.	TOT. TEETH	ACTUAL TEETH	ADJ. BORE	Ass.	POS	AXIAL ANGLE	FEED RATE	CODICE / SKU	CODICE / SKU	
250	12	60	24	20+4	S-SYSTEM160	7°	6	-10°	25-30	TRC6004001	TRC6004002	
250	12	60	30	24+6	S-SYSTEM160	7°	6	-10°	35-40	TRC6004003	TRC6004004	
250	12	60	36	30+6	S-SYSTEM160	7°	6	-10°	40-50	TRC6004005	TRC6004006	
250	12	60	42	36+6	S-SYSTEM160	7°	6	-10°	45-60	TRC6004007	TRC6004008	
250	12	60	48	42+6	S-SYSTEM160	7°	6	-10°	60-80	TRC6004009	TRC6004010	
250	12	80	24	20+4	S-SYSTEM192	7°	6	-10°	25-30	TRC6004011	TRC6004012	
250	12	80	30	24+6	S-SYSTEM192	7°	6	-10°	35-40	TRC6004013	TRC6004014	
250	12	80	36	30+6	S-SYSTEM192	7°	6	-10°	40-50	TRC6004015	TRC6004016	
250	12	80	42	36+6	S-SYSTEM192	7°	6	-10°	45-60	TRC6004017	TRC6004018	
250	12	80	48	42+6	S-SYSTEM192	7°	6	-10°	60-80	TRC6004019	TRC6004020	
250	12	80+	24	20+4	4(9/100)	7°	6	-10°	25-30	TRC6004021	TRC6004022	
250	12	80+	30	24+6	4(9/100)	7°	6	-10°	35-40	TRC6004023	TRC6004024	
250	12	80+	36	30+6	4(9/100)	7°	6	-10°	40-50	TRC6004025	TRC6004026	
250	12	80+	42	36+6	4(9/100)	7°	6	-10°	45-60	TRC6004027	TRC6004028	
250	12	80+	48	42+6	4(9/100)	7°	6	-10°	60-80	TRC6004029	TRC6004030	



FRESE CON FORO - SQUADRATRICE BORDATRICE

CUTTERS WITH BORE - SQUARING EDGEBANDING

FRESE CON FORO - SQUADRATRICE BORDATRICE

CUTTERS WITH BORE - SQUARING EDGEBANDING



FFD4001 FFD4009 FFD4020
FFD4003 FFD4011 FFD4022
FFD4005 FFD4014
FFD4007 FFD4016

FRESE BORDATRICI AD ELICA
IN DIAMANTE PCD H2.5/4.5 MM
ASSIALE 30°
DIAMOND JOINTING CUTTER WITH
HELICOIDAL WINGS PCD H2.5/4.5 MM
AXIAL 30°

49
PAG.



FFD4002 FFD4010 FFD4021
FFD4004 FFD4012 FFD4023
FFD4006 FFD4015
FFD4008 FFD4017

FRESE BORDATRICI AD ELICA
IN DIAMANTE PCD H2.5/4.5 MM
ASSIALE 30° CON ASOLE ANTIROMORE
DIAMOND JOINTING CUTTER
PCD H2.5/4.5 MM AXIAL 30°
WITH LOW NOISE SLOTS

53
PAG.



FFD4013 FFD4018 FFD4024

FRESE BORDATRICI AD ELICA
IN DIAMANTE PCD H2.5/4.5 MM
ASSIALE 30° CON ASOLE ANTIROMORE
DIAMOND JOINTING CUTTER
PCD H2.5/4.5 MM AXIAL 30°
WITH LOW NOISE SLOTS

57
PAG.



FFD4019 FFD4025

FRESE BORDATRICI AD ELICA
IN DIAMANTE PCD H4.5 MM
ASSIALE 54.9°
DIAMOND JOINTING CUTTER
WITH HELICOIDAL WINGS PCD H4.5
MM AXIAL 54.9°

60
PAG.



LIGHT FLEX 1 FFD4026

FRESE BORDATRICI AD INSERTI
IN DIAMANTE PCD H3 ASSIALE 35°
JOINTING CUTTER WITH PCD INSERTS
PCD H3 AXIAL 35°

62
PAG.



LIGHT FLEX 2 FFD4027

FRESE BORDATRICI AD INSERTI
IN DIAMANTE PCD H3 ASSIALE 45°
JOINTING CUTTER WITH PCD
INSERTS PCD H3 AXIAL 45°

63
PAG.



LIGHT FLEX 3 FFD4028

FRESE BORDATRICI AD INSERTI
IN DIAMANTE PCD H3 MM
ASSIALE 54.9°
JOINTING CUTTER WITH PCD INSERTS
PCD H3 MM AXIAL 54.9°

64
PAG.



AIRCUT 2 FFD4041

FRESE BORDATRICI AD INSERTI
IN DIAMANTE PCD H2.5 MM
ASSIALE 30°
JOINTING CUTTER WITH PCD
INSERTS PCD H2.5 MM AXIAL 30°

65
PAG.



AIRCUT 3 FFD4042

FRESE BORDATRICI AD INSERTI
IN DIAMANTE PCD H2.5 MM
ASSIALE 45°
JOINTING CUTTER WITH PCD
INSERTS PCD H2.5 MM AXIAL 45°

67
PAG.



DIAFIX 1 FFD4043

FRESE BORDATRICI AD INSERTI IN DIA-
MANTE PCD H5.5 ASSIALE 30°. INSERTI
REGOLABILI ASSIALMENTE E DIAMET-
RO COSTANTE POST AFFILATURA
PCD INSERTS JOINTING CUTTER WITH
CONSTAND DIAMETER

NEW
68
PAG.



TRS 1 FFD4030

FRESE RETTIFICA REGOLABILI
ASSIALITA' 30°
DIA ADJUSTABLE JOINTING
CUTTER CUTTING ANGLE 30°

69
PAG.



TRS 2 FFD4031

FRESE RETTIFICA REGOLABILI
ASSIALITA' 45°
DIA ADJUSTABLE JOINTING
CUTTER CUTTING ANGLE 45°

70
PAG.



TRS 3 FFD4032

FRESE RETTIFICA REGOLABILI
ASSIALITA' 54.9°
DIA ADJUSTABLE JOINTING CUTTER
CUTTING ANGLE 54.9°

71
PAG.



TRS 4 FFD4033

FRESE RETTIFICA INTERCAMBIABILE
CON REGOLAZIONE MICROMETRICA
HYDRO ASSIALITA' 45°
DIA ADJUSTABLE CHANGEABLE
JOINTING CUTTER PROGRESSIVE WITH
HYDRO SLEEVE AXIAL 45°

72
PAG.



TRS 5 FFD4034

FRESE RETTIFICA INTERCAMBIABILE
REGOLAZIONE MICROMETRICA HYDRO
ASSIALITA' 54.9° CORPO IN ACCIAIO
DIA ADJUSTABLE CHANGEABLE
JOINTING CUTTER PROGRESSIVE WITH
HYDRO SLEEVE AXIAL 54.9° STEEL BODY

72
PAG.



TRS 6 FFD4045

FRESE RETTIFICA
CON REGOLAZIONE MICROMETRICA
INDIPENDENTE ASSIALITA' 45°
DIA JOINTING CUTTERS
WITH INDEPENDENT MICROMETRIC
ADJUSTMENT CUTTING ANGLE 45°

NEW
73
PAG.



GROOVINGCUT 2 FFD4035

FRESE REGOLABILI
PER CANALI
DIA ADJUSTABLE
GROOVING CUTTER

74
PAG.



GROOVINGCUT 4 FFD4046

FRESE REGOLABILI PER CANALI AD
ELEMENTI INTERCAMBIABILI
DIA ADJUSTABLE GROOVING
SAW WITH INTERCHANGEABLE
ELEMENTS

NEW
75
PAG.



GROOVINGCUT 3 FFD4036

FRESE REGOLABILI PER CANALI
CON SPIGLATORI REGOLABILI
DIA ADJUSTABLE GROOVING
CUTTER WITH ADJUSTABLE
CHANFERING KNIFE

76
PAG.

FRESE CON FORO - SQUADRATRICE BORDATRICE

CUTTERS WITH BORE - SQUARING EDGEBANDING



FFD4029
FRESE BORDATRICI PER RIFILARE
PRE FINISHING EDGE TRIMMING CUTTER

76
PAG.



FFS5006
FRESE BORDATRICE IN DIAMANTE PER RAGGIARE E SMUSSARE PER MACCHINA HOLZ-HER 1826
DIAMOND EDGE ROUNDING AND CHAMFERING CUTTERS FOR HOLZ-HER 1826

81
PAG.



FFD4037
FRESE BORDATRICI PER CONTORNARE CON HSK25R
PRE FINISHING EDGE TRIMMING CUTTER HSK

77
PAG.



FFS5007
FRESE BORDATRICE IN DIAMANTE PER RAGGIARE E SMUSSARE PER MACCHINA HOLZ-HER FR701
DIAMOND EDGE ROUNDING AND CHAMFERING CUTTERS FOR HOLZ-HER FR701

82
PAG.



FFD4038
FRESE BORDATRICI PER CONTORNARE MACCHINA STEFANI-FRAVOL
PRE FINISHING EDGE TRIMMING CUTTER STEFANI-FRAVOL MACHINES

77
PAG.



FFS5008
FRESE BORDATRICI IN DIAMANTE PER RAGGIARE MACCHINA SCM STEFANI ROUNDK AIR SYSTEM Z3
DIAMOND EDGE ROUNDING CUTTERS FOR SCM - STEFANI ROUNDK AIR SYSTEM Z3

82
PAG.



FFD4040
FRESE BORDATRICI PER CONTORNARE CON HSK25R PER HOMAG-IMA
PRE FINISHING EDGE TRIMMING CUTTER HSK25R FOR HOMAG-IMA

78
PAG.



FFS5018
FRESE BORDATRICE PORTAINSERTI INTERCAMBIABILI IN DIAMANTE
PCD INSERTS EDGE BANDER CUTTER

NEW
83
PAG.



FFD4044
FRESE PER BATTUTE PCD H4,5 ASSIALE POSITIVO NEGATIVO
PCD REBATING CUTTER POS/NEG AXIAL CUT PCD H 4,5

NEW
78
PAG.



FFS5009
FRESE BORDATRICI IN DIAMANTE PER RAGGIARE MACCHINA SCM IDM C1/C2 CON AIR SYSTEM
DIAMOND EDGE ROUNDING CUTTERS FOR SCM - IDM WITH AIR SYSTEM

84
PAG.



FFS5001
FRESE BORDATRICE IN DIAMANTE RAGGIATRICI PER MACCHINA HOLZ-HER
DIAMOND EDGE ROUNDING CUTTERS FOR HOLZ-HER

79
PAG.



FFS5010
FRESE PER RAGGIARE Z6 MACCHINA BIESSE ERGHO AKRON
DIAMOND EDGE Z6 ROUNDING CUTTERS FOR BIESSE ERGHO AKRON

84
PAG.



FFS5002
FRESE BORDATRICI IN DIAMANTE PER RAGGIARE MACCHINA HOLZ-HER 1832 CON AIR SYSTEM
DIAMOND EDGE ROUNDING CUTTERS FOR HOLZ-HER 1832 WITH AIR SYSTEM

79
PAG.



FFS5011
FRESE PER RAGGIARE Z6 MACCHINA BIESSE
DIAMOND EDGE ROUNDING Z6 CUTTERS FOR BIESSE

85
PAG.



FFS5003
FRESE BORDATRICE IN DIAMANTE RAGGIATRICI PER MACCHINA HOLZ-HER 1827
DIAMOND EDGE ROUNDING CUTTERS FOR HOLZ-HER 1827

80
PAG.



FFS5012
FRESE PER RAGGIARE MACCHINA HOMAG FF - IMA
DIAMOND EDGE ROUNDING CUTTERS FOR HOMAG FF - IMA

85
PAG.



FFS5004
FRESE BORDATRICE IN DIAMANTE RAGGIATRICI PER MACCHINA HOLZ-HER FR201 CON AIR SYSTEM
DIAMOND EDGE ROUNDING CUTTERS FOR HOLZ-HER FR201 WITH AIR SYSTEM

80
PAG.



FFS5013
FRESE PER SMUSSARE HSK32 MACCHINA HOMAG
DIAMOND EDGE CHAMFERING CUTTERS FOR HOMAG

86
PAG.



FFS5005
FRESE BORDATRICI IN DIAMANTE PER RAGGIARE MACCHINA HOLZ-HER 1833 CON AIR SYSTEM
DIAMOND EDGE ROUNDING CUTTERS FOR HOLZ-HER 1833 WITH AIR SYSTEM

81
PAG.



FFS5014
FRESE PER RAGGIARE HSK32 MACCHINA HOMAG
DIAMOND EDGE ROUNDING CUTTERS FOR HOMAG

87
PAG.



JOINT CUT 2 FFS5016

FRESA REGOLABILE PER GIUNZIONI
CON FORO
AJUSTANLE CUTTER FOR JOINTING

NEW

88
PAG.



FFS5017

FRESA RAGGIATRICE Z4
CON COPIATORE
PCD RADIUS CUTTER WITH COPIER

NEW

88
PAG.



V CUT 8 FFS5015

FRESA CON FORO PER SMUSSARE
PANNELLI A 45° CON ANGOLO ASSIALE
POSITIVO NEGATIVO
HOLE CUTTER WITH HOLE FOR CUT-
TING PANELS AT 45° WITH POSITIVE
NEGATIVE AXIAL ANGLE

NEW

89
PAG.

BASSOFONDI - TYPE

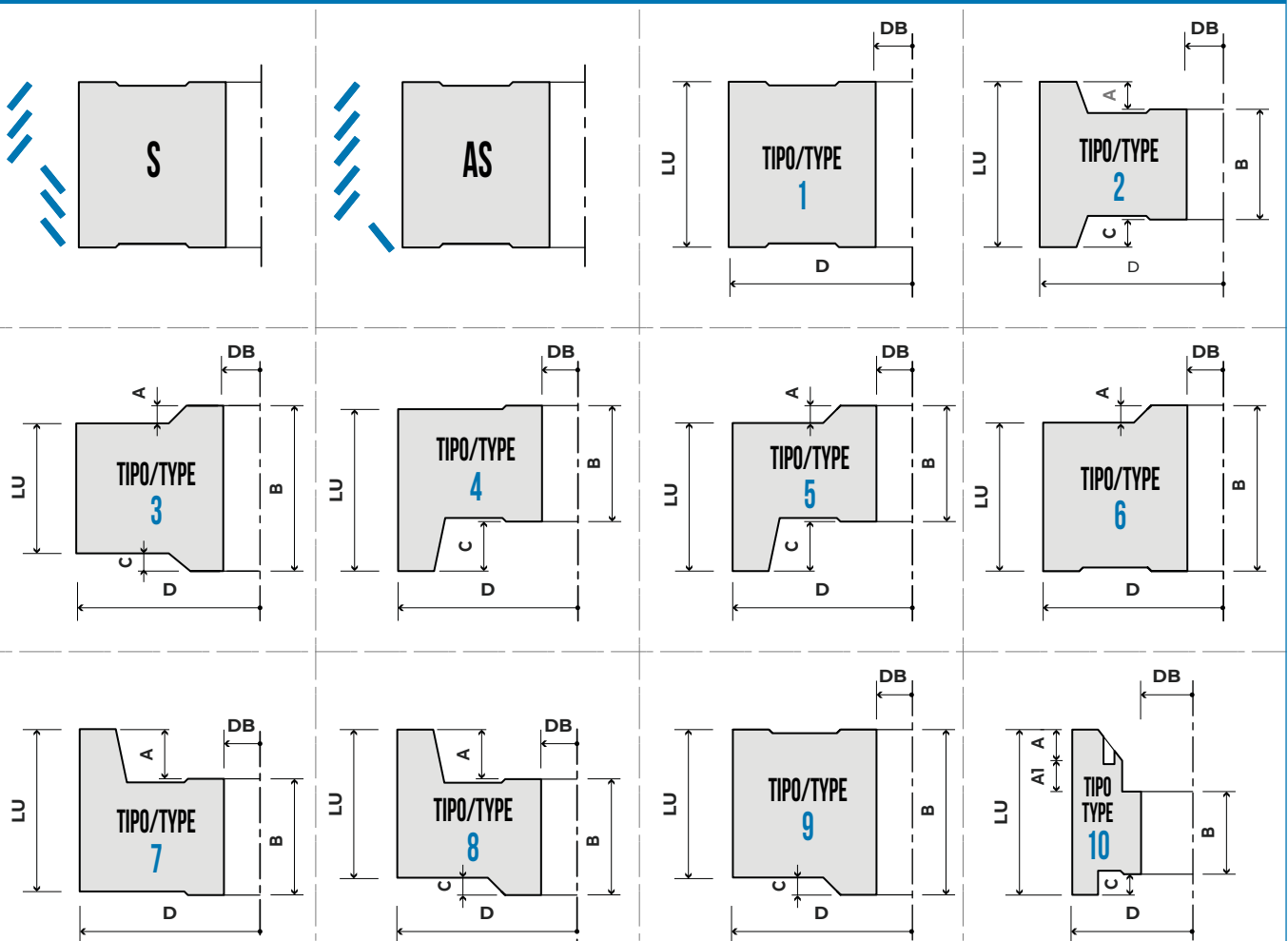

FFD4001 - FFD4003 - FFD4005 - FFD4007 - FFD4009 - FFD4011 - FFD4014 - FFD4016 - FFD4020 - FFD4022

FRESE BORDATRICI AD ELICA
IN DIAMANTE PCD
H2.5/4.5 MM ASSIALE 30°

DIAMOND JOINTING CUTTER
WITH HELICOIDAL WINGS PCD
H2.5/4.5 MM AXIAL 30°

Frese bordatrici per rettifica ad elica in diamante con placchetta H2.5 / 4.5 mm e angolo assiale di taglio 30°.

Diamond jointing cutter with helicoidal wings PCD H2.5 / 4.5 mm axial 30°.

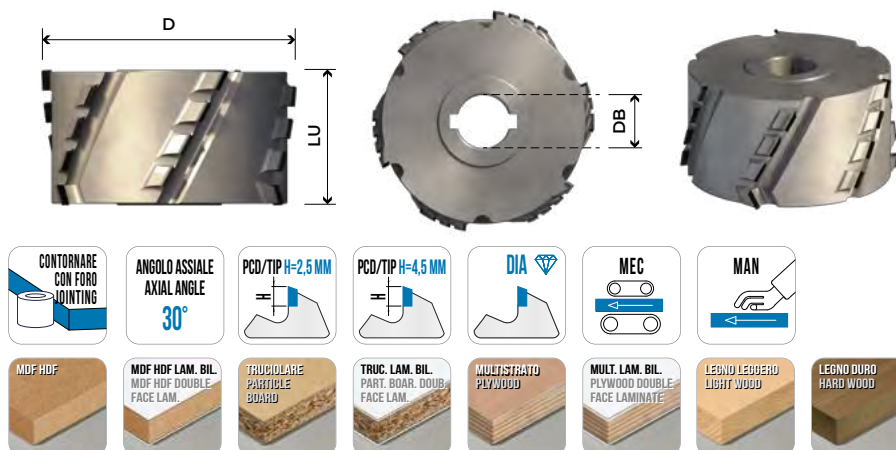

D60		DIMENSIONI DIMENSIONS		MACCHINA		ARTICOLI ITEMS												
D	LU	Z	Z TOT	DB	β°	A	AI	B	C	S/AS	TYPE	MACHINE BRANDS	FFD4001 - H2,5 mm		PREZZI €	FFD4003 - H4,5 mm		PREZZI €
Pag. 232													COD SX / LH	COD DX / RH	PRICES €	COD SX / LH	COD DX / RH	PRICES €
60	36	2+2	8	20	30°	6,5		43,5		AS	6	CEHISA	FFD4001001	FFD4001002		FFD4003001	FFD4003002	
60	36	3+3	12	20	30°	6,5		43,5		AS	6	CEHISA	FFD4001003	FFD4001004		FFD4003003	FFD4003004	
60	48	2+2	12	25	30°					AS	1	FRAVOL	FFD4001005	FFD4001006		FFD4003005	FFD4003006	
60	48	3+3	18	25	30°					AS	1	FRAVOL	FFD4001007	FFD4001008		FFD4003007	FFD4003008	
60	48	2+2	12	25	30°	14				AS	6	FELDER	FFD4001009	FFD4001010		FFD4003009	FFD4003010	
60	48	3+3	18	25	30°	14				AS	6	FELDER	FFD4001011	FFD4001012		FFD4003011	FFD4003012	
60	48	2+2	12	20	30°	7				AS	7		FFD4001013	FFD4001014		FFD4003013	FFD4003014	
60	48	3+3	18	20	30°	7				AS	7		FFD4001015	FFD4001016		FFD4003015	FFD4003016	
60	55	2+2	14	20	30°					AS	1		FFD4001017	FFD4001018		FFD4003017	FFD4003018	
60	55	3+3	21	20	30°					AS	1		FFD4001019	FFD4001020		FFD4003019	FFD4003020	
60	55	2+2	14	25	30°					AS	1		FFD4001021	FFD4001022		FFD4003021	FFD4003022	
60	55	3+3	21	25	30°					AS	1		FFD4001023	FFD4001024		FFD4003023	FFD4003024	
60	55	2+2	14	16	30°	12		31	12	S	2		FFD4001025	FFD4001025		FFD4003025	FFD4003025	
60	55	3+3	21	16	30°	12		31	12	S	2		FFD4001027	FFD4001027		FFD4003027	FFD4003027	
60	55	2+2	14	20	30°	13		43,5		AS	7	CEHISA	FFD4001029	FFD4001030		FFD4003029	FFD4003030	
60	55	3+3	21	20	30°	13		43,5		AS	7	CEHISA	FFD4001031	FFD4001032		FFD4003031	FFD4003032	
60	55	2+2	14	25	30°	3,5		48	3,5	AS	2	CASADEI	FFD4001045	FFD4001046		FFD4003045	FFD4003046	
60	55	3+3	21	25	30°	3,5		48	3,5	AS	2	CASADEI	FFD4001047	FFD4001048		FFD4003047	FFD4003048	
60	65	2+2	16	20	30°					AS	1		FFD4001033	FFD4001034		FFD4003033	FFD4003034	
60	65	3+3	24	20	30°					AS	1		FFD4001035	FFD4001036		FFD4003035	FFD4003036	
60	65	2+2	16	25	30°					AS	1	FELDER FORMAT 4/ FRAVOL	FFD4001037	FFD4001038		FFD4003037	FFD4003038	
60	65	3+3	24	25	30°					AS	1	FELDER FORMAT 4/ FRAVOL	FFD4001039	FFD4001040		FFD4003039	FFD4003040	
60	65	2+2	16	25	30°	8				AS	7	FRAVOL	FFD4001041	FFD4001042		FFD4003041	FFD4003042	
60	65	3+3	24	25	30°	8				AS	7	FRAVOL	FFD4001043	FFD4001044		FFD4003043	FFD4003044	

D70		DIMENSIONI DIMENSIONS		MACCHINA		ARTICOLI ITEMS												
D	LU	Z	Z TOT	DB	β°	A	AI	B	C	S/AS	TYPE	MACHINE BRANDS	FFD4005 - H2,5 mm		PREZZI €	FFD4007 - H4,5 mm		PREZZI €
Pag. 232													COD SX / LH	COD DX / RH	PRICES €	COD SX / LH	COD DX / RH	PRICES €
70	45	2+2	12	30	30°	16				AS	6		FFD4005001	FFD4005002		FFD4007001	FFD4007002	
70	45	3+3	18	30	30°	16				AS	6		FFD4005003	FFD4005004		FFD4007003	FFD4007004	
70	48	2+2	12	30	30°	9	9	24	6	AS	10	HOLZ-HER	FFD4005005	FFD4005006		FFD4007005	FFD4007006	
70	48	3+3	18	30	30°	9	9	24	6	AS	10	HOLZ-HER	FFD4005007	FFD4005008		FFD4007007	FFD4007008	
70	48	2+2	12	30	30°	9		41	6	AS	5	HOLZ-HER ARCUS 1801	FFD4005009	FFD4005010		FFD4007009	FFD4007010	
70	48	3+3	18	30	30°	9		41	6	AS	5	HOLZ-HER ARCUS 1801	FFD4005011	FFD4005012		FFD4007011	FFD4007012	
70	48	2+2	12	30	30°	8				AS	7		FFD4005013	FFD4005014		FFD4007013	FFD4007014	
70	48	3+3	18	30	30°	8				AS	7		FFD4005015	FFD4005016		FFD4007015	FFD4007016	
70	48	2+2	12	25	30°	12		61		AS	6	HEBROCK	FFD4005017	FFD4005018		FFD4007017	FFD4007018	
70	48	3+3	18	25	30°	12		61		AS	6	HEBROCK	FFD4005019	FFD4005020		FFD4007019	FFD4007020	
70	48	2+2	12	25	30°	11		70	11	AS	3		FFD4005021	FFD4005022		FFD4007021	FFD4007022	
70	48	2+2	18	25	30°	11		70	11	AS	3		FFD4005023	FFD4005024		FFD4007023	FFD4007024	
70	55	2+2	14	30	30°	9,5	9	30,5	6	AS	10	HOLZ-HER AGGREGATE 1801	FFD4005025	FFD4005026		FFD4007025	FFD4007026	
70	55	3+3	21	30	30°	9,5	9	30,5	6	AS	10	HOLZ-HER AGGREGATE 1801	FFD4005027	FFD4005028		FFD4007027	FFD4007028	
70	65	2+2	16	30	30°	9,5	9	40,5	6	AS	10	HOLZ-HER ARCUS 1801	FFD4005029	FFD4005030		FFD4007029	FFD4007030	
70	65	3+3	24	30	30°	9,5	9	40,5	6	AS	10	HOLZ-HER ARCUS 1801	FFD4005031	FFD4005032		FFD4007031	FFD4007032	

D80

DIMENSIONI		DIMENSIONS		MACCHINA								ARTICOLI				ITEMS		
D	LU	Z	Z TOT	DB	β°	A	AI	B	C	S/AS	TYPE	MACHINE BRANDS	FFD4009 - H2,5 mm		PREZZI €	FFD4011 - H4,5 mm		PREZZI €
													COD SX / LH	COD DX / RH	PRICES €	COD SX / LH	COD DX / RH	PRICES €
80	25	2+2	6	30	30°					AS	1		FFD4009001	FFD4009002		FFD4011001	FFD4011002	
80	25	3+3	9	30	30°					AS	1		FFD4009003	FFD4009004		FFD4011003	FFD4011004	
80	30	2+2	8	30	30°	11,5		53	11,5	S	3	BIESSE AKRON 1300 AKRON 1400 AKRON 400 AKRON 800 ROXYL STREAM A JADE 240	FFD4009005	FFD4009005		FFD4011005	FFD4011005	
80	30	3+3	12	30	30°	11,5		53	11,5	S	3	BIESSE AKRON 1300 AKRON 1400 AKRON 400 AKRON 800 ROXYL STREAM A JADE 240	FFD4009007	FFD4009007		FFD4011007	FFD4011007	
80	40	2+2	10	30	30°					AS	1	SCM	FFD4009009	FFD4009010		FFD4011009	FFD4011010	
80	40	3+3	15	30	30°					AS	1	SCM	FFD4009011	FFD4009012		FFD4011011	FFD4011012	
80	45	2+2	12	30	30°	4		53	4	S	3	BIESSE AKRON 1300 AKRON 1400 AKRON 400 AKRON 800 ROXYL STREAM A JADE 240	FFD4009013	FFD4009013		FFD4011013	FFD4011013	
80	45	3+3	18	30	30°	4		53	4	S	3	BIESSE AKRON 1300 AKRON 1400 AKRON 400 AKRON 800 ROXYL STREAM A JADE 240	FFD4009015	FFD4009015		FFD4011015	FFD4011015	
80	48	2+2	12	30	30°					AS	1		FFD4009017	FFD4009018		FFD4011017	FFD4011018	
80	48	3+3	18	30	30°					AS	1		FFD4009019	FFD4009020		FFD4011019	FFD4011020	
80	48	2+2	12	25	30°	15		63		AS	6	FELDER	FFD4009021	FFD4009022		FFD4011021	FFD4011022	
80	48	3+3	18	25	30°	15		63		AS	6	FELDER	FFD4009023	FFD4009024		FFD4011023	FFD4011024	
80	48	2+2	12	20	30°	11,5		25	11,5	S	2	BIESSE AKRON 246	FFD4009025	FFD4009026		FFD4011025	FFD4011025	
80	48	3+3	18	20	30°	11,5		25	11,5	S	2	BIESSE AKRON 246	FFD4009027	FFD4009027		FFD4011027	FFD4011027	
80	55	2+2	14	30	30°					AS	1	SCM ME-35 MINIMAX	FFD4009029	FFD4009030		FFD4011029	FFD4011030	
80	55	3+3	21	30	30°					AS	1	SCM ME-35 MINIMAX	FFD4009031	FFD4009032		FFD4011031	FFD4011032	
80	55	2+2	14	20	30°	17		25	13	AS	2	BIESSE AKRON 246 GRIGGIO	FFD4009033	FFD4009034		FFD4011033	FFD4011034	
80	55	3+3	21	20	30°	17		25	13	AS	2	BIESSE AKRON 246 GRIGGIO	FFD4009035	FFD4009036		FFD4011035	FFD4011036	
80	65	2+2	16	25	30°					AS	1		FFD4009037	FFD4009038		FFD4011037	FFD4011038	
80	65	3+3	24	25	30°					AS	1		FFD4009039	FFD4009040		FFD4011039	FFD4011040	
80	65	2+2	16	30	30°	6		53	6	S	2	BIESSE AKRON 1300 AKRON 1400 AKRON 400 AKRON 800 ROXYL STREAM A JADE 240	FFD4009041	FFD4009041		FFD4011041	FFD4011041	
80	65	3+3	24	30	30°	6		53	6	S	2	BIESSE AKRON 1300 AKRON 1400 AKRON 400 AKRON 800 ROXYL STREAM A JADE 240	FFD4009043	FFD4009043		FFD4011043	FFD4011043	
80	65	2+2	16	30	30°	10		56		AS	7		FFD4009045	FFD4009046		FFD4011045	FFD4011046	
80	65	3+3	24	30	30°	10		56		AS	7		FFD4009047	FFD4009048		FFD4011047	FFD4011048	
80	65	2+2	16	30	30°	28		25	12	AS	2	GRIGGIO	FFD4009049	FFD4009050		FFD4011049	FFD4011050	
80	65	3+3	24	30	30°	28		25	12	AS	2	GRIGGIO	FFD4009051	FFD4009052		FFD4011051	FFD4011052	
80	65	2+2	16	20	30°	21,5		37	6,5	AS	2	CEHISA	FFD4009053	FFD4009054		FFD4011053	FFD4011054	
80	65	3+3	24	20	30°	21,5		37	6,5	AS	2	CEHISA	FFD4009055	FFD4009056		FFD4011055	FFD4011056	

D85

DIMENSIONI		DIMENSIONS		MACCHINA								ARTICOLI				ITEMS		
D	LU	Z	Z TOT	DB	β°	A	AI	B	C	S/AS	TYPE	MACHINE BRANDS	FFD4009 - H2,5 mm		PREZZI €	FFD4011 - H4,5 mm		PREZZI €
													COD SX / LH	COD DX / RH	PRICES €	COD SX / LH	COD DX / RH	PRICES €
85	45	3+3	18	30	30°					AS	1	OTT	FFD4009057	FFD4009058		FFD4011057	FFD4011058	
85	65	3+3	24	30	30°	15				AS	7	OTT	FFD4009059	FFD4009060		FFD4011059	FFD4011060	



D	LU	Z	Z TOT	DB	β°	A	AI	B	C	S/AS	TYPE	MACHINE BRANDS	COD SX / LH	COD DX / RH	PRICES €	COD SX / LH	COD DX / RH	PRICES €
100	35	2+2	12	30	30°					AS	1	IMA BRANDT	FFD4014001	FFD4014002		FFD4016001	FFD4016002	
100	35	3+3	12	30	30°					AS	1	IMA BRANDT	FFD4014003	FFD4014004		FFD4016003	FFD4016004	
100	45	2+2	12	30	30°					AS	1		FFD4014005	FFD4014006		FFD4016005	FFD4016006	
100	45	3+3	18	30	30°					AS	1		FFD4014007	FFD4014008		FFD4016007	FFD4016008	
100	45	2+2	12	30	30°					S	1		FFD4014009	FFD4014009		FFD4016009	FFD4016009	
100	45	3+3	18	30	30°					S	1		FFD4014011	FFD4014011		FFD4016011	FFD4016011	
100	45	2+2	12	30	30°	5,4		40,6		AS	7	BRANDT	FFD4014013	FFD4014014		FFD4016013	FFD4016014	
100	45	3+3	18	30	30°	5,4		40,6		AS	7	BRANDT	FFD4014015	FFD4014016		FFD4016015	FFD4016016	
100	45	2+2	12	30	30°	16		61		AS	6	HEBROCK EBM BRANDT AMBITION 1110 F	FFD4014017	FFD4014018		FFD4016017	FFD4016018	
100	45	3+3	18	30	30°	16		61		AS	6	HEBROCK EBM BRANDT AMBITION 1110 F	FFD4014019	FFD4014020		FFD4016019	FFD4016020	
100	45	2+2	12	30	30°	12		75	15	AS	3		FFD4014021	FFD4014022		FFD4016021	FFD4016022	
100	45	3+3	18	30	30°	12		75	15	AS	3		FFD4014023	FFD4014024		FFD4016023	FFD4016024	
100	48	2+2	12	25	30°					AS	1		FFD4014025	FFD4014026		FFD4016025	FFD4016026	
100	48	3+3	18	25	30°					AS	1		FFD4014027	FFD4014028		FFD4016027	FFD4016028	
100	48	2+2	12	30	30°	11,5		25	11,5	AS	2	HOLZ - SCM HER UP TO 2008	FFD4014029	FFD4014030		FFD4016029	FFD4016030	
100	48	3+3	18	30	30°	11,5		25	11,5	AS	2	HOLZ - SCM HER UP TO 2008	FFD4014031	FFD4014032		FFD4016031	FFD4016032	
100	48	2+2	12	30	30°	7,4		40,6		AS	7	BRANDT - IMA SCM K360 K560 IDM - BIESSE	FFD4014033	FFD4014034		FFD4016033	FFD4016034	
100	48	3+3	18	30	30°	7,4		40,6		AS	7	BRANDT - IMA SCM K360 K560 IDM - BIESSE	FFD4014035	FFD4014036		FFD4016035	FFD4016036	
100	48	2+2	12	30	30°	4		40	4	AS	2	BRANDT - IMA SCM K360 K560 IDM - BIESSE	FFD4014037	FFD4014038		FFD4016037	FFD4016038	
100	48	3+3	18	30	30°	4		40	4	AS	2	BRANDT - IMA SCM K360 K560 IDM - BIESSE	FFD4014039	FFD4014040		FFD4016039	FFD4016040	
100	55	2+2	14	30	30°					AS	1		FFD4014041	FFD4014042		FFD4016041	FFD4016042	
100	55	3+3	21	30	30°					AS	1		FFD4014043	FFD4014044		FFD4016043	FFD4016044	
100	55	2+2	14	30	30°	18,5		25	11,5	AS	2	HOLZ - SCM HER UP TO 2008	FFD4014045	FFD4014046		FFD4016045	FFD4016046	
100	55	3+3	21	30	30°	18,5		25	11,5	AS	2	HOLZ - SCM HER UP TO 2008	FFD4014047	FFD4014048		FFD4016047	FFD4016048	
100	55	2+2	14	30	30°	14,4		40,6		AS	7	BRANDT - IMA SCM K360 K560 IDM - BIESSE	FFD4014049	FFD4014050		FFD4016049	FFD4016050	
100	55	3+3	21	30	30°	14,4		40,6		AS	7	BRANDT - IMA SCM K360 K560 IDM - BIESSE	FFD4014051	FFD4014052		FFD4016051	FFD4016052	
100	65	2+2	16	30	30°					AS	1		FFD4014053	FFD4014054		FFD4016053	FFD4016054	
100	65	3+3	24	30	30°					AS	1		FFD4014055	FFD4014056		FFD4016055	FFD4016056	
100	65	2+2	16	30	30°	5		75	5	S	3	BIESSE AKRON 600 AKRON 800	FFD4014057	FFD4014057		FFD4016057	FFD4016057	
100	65	3+3	24	30	30°	5		75	5	S	3	BIESSE AKRON 600 AKRON 800	FFD4014059	FFD4014059		FFD4016059	FFD4016059	
100	65	2+2	16	30	30°	25,4		40,6		AS	7	BRANDT - IMA SCM K360 K560 IDM - BIESSE	FFD4014061	FFD4014062		FFD4016061	FFD4016062	
100	65	3+3	24	30	30°	25,4		40,6		AS	7	BRANDT - IMA SCM K360 K560 IDM - BIESSE	FFD4014063	FFD4014064		FFD4016063	FFD4016064	
100	65	2+2	16	30	30°	12		26	27	AS	2	HOLZ - SCM HER UP TO 2008	FFD4014065	FFD4014066		FFD4016065	FFD4016066	
100	65	3+3	24	30	30°	12		26	27	AS	2	HOLZ - SCM HER UP TO 2008	FFD4014067	FFD4014068		FFD4016067	FFD4016068	
100	65	2+2	16	20	30°	21,5		37	6,5	AS	2	CEHISA	FFD4014069	FFD4014070		FFD4016069	FFD4016070	
100	65	3+3	24	20	30°	21,5		37	6,5	AS	2	CEHISA	FFD4014071	FFD4014072		FFD4016071	FFD4016072	
100	65	2+2	16	30	30°	16		40	9	AS	2	HOLZ-HER	FFD4014073	FFD4014074		FFD4016073	FFD4016074	
100	65	3+3	24	30	30°	16		40	9	AS	2	HOLZ-HER	FFD4014075	FFD4014076		FFD4016075	FFD4016076	
100	65	2+2	16	30	30°	16		40	9	S	2	HOLZ-HER	FFD4014077	FFD4014078		FFD4016077	FFD4016078	
100	65	3+3	24	30	30°	16		40	9	S	2	HOLZ-HER	FFD4014079	FFD4014080		FFD4016079	FFD4016080	

D125

DIMENSIONI DIMENSIONS

MACCHINA

ARTICOLI ITEMS

Pag. 232											FFD4020 - H2,5 mm		PREZZI €	FFD4022 - H4,5 mm		PREZZI €		
D	LU	Z	TOT	DB	β°	A	AI	B	C	S/AS	TYPE	MACHINE BRANDS	COD SX / LH	COD DX / RH	PRICES €	COD SX / LH	COD DX / RH	PRICES €
125	34	3+3	12	30	30°					AS	1	IMA/HOMAG	FFD4020001	FFD4020002		FFD4022001	FFD4022002	
125	34	4+4	16	30	30°					AS	1	IMA/HOMAG	FFD4020003	FFD4020004		FFD4022003	FFD4022004	
125	43	3+3	18	30	30°	14		57		AS	6		FFD4020005	FFD4020006		FFD4022005	FFD4022006	
125	43	4+4	24	30	30°	14		57		AS	6		FFD4020007	FFD4020008		FFD4022007	FFD4022008	
125	45	3+3	18	30	30°					AS	1	IMA	FFD4020009	FFD4020010		FFD4022009	FFD4022010	
125	45	4+4	24	30	30°					AS	1	IMA	FFD4020011	FFD4020012		FFD4022011	FFD4022012	
125	45	3+3	18	30	30°	6				AS	7	HOMAG	FFD4020013	FFD4020014		FFD4022013	FFD4022014	
125	45	4+4	24	30	30°	6				AS	7	HOMAG	FFD4020015	FFD4020016		FFD4022015	FFD4022016	
125	48	3+3	18	30	30°					AS	1		FFD4020017	FFD4020018		FFD4022017	FFD4022018	
125	48	4+4	24	30	30°					AS	1		FFD4020019	FFD4020020		FFD4022019	FFD4022020	
125	48	3+3	18	30	30°	4		40	4	AS	2	HOMAG	FFD4020021	FFD4020022		FFD4022021	FFD4022022	
125	48	4+4	24	30	30°	4		40	4	AS	2	HOMAG	FFD4020023	FFD4020024		FFD4022023	FFD4022024	
125	65	3+3	24	30	30°					AS	1		FFD4020025	FFD4020026		FFD4022025	FFD4022026	
125	65	4+4	32	30	30°					AS	1		FFD4020027	FFD4020028		FFD4022027	FFD4022028	
125	65	3+3	24	30	30°	8		49	8	AS	2	BIESSE	FFD4020029	FFD4020030		FFD4022029	FFD4022030	
125	65	4+4	32	30	30°	8		49	8	AS	2	BIESSE	FFD4020031	FFD4020032		FFD4022031	FFD4022032	
125	65	3+3	24	30	30°	25,4		40,6		AS	7	BRANDT-IMA-SCM IDM - BIESSE	FFD4020033	FFD4020034		FFD4022033	FFD4022034	
125	65	4+4	32	30	30°	25,4		40,6		AS	7	BRANDT-IMA-SCM IDM - BIESSE	FFD4020035	FFD4020036		FFD4022035	FFD4022036	
125	65	3+3	24	30	30°	12,5		40	12,5	AS	2	HOMAG	FFD4020037	FFD4020038		FFD4022037	FFD4022038	
125	65	4+4	32	30	30°	12,5		40	12,5	AS	2	HOMAG	FFD4020039	FFD4020040		FFD4022039	FFD4022040	
125	65	3+3	24	30	30°	28		25	12	AS	2	GRIGGIO/HOLZ-HER	FFD4020041	FFD4020042		FFD4022041	FFD4022042	
125	65	4+4	32	30	30°	28		25	12	AS	2	GRIGGIO/HOLZ-HER	FFD4020043	FFD4020044		FFD4022043	FFD4022044	

D150

DIMENSIONI DIMENSIONS

MACCHINA

ARTICOLI ITEMS

Pag. 232											FFD4020 - H2,5 mm		PREZZI €	FFD4022 - H4,5 mm		PREZZI €		
D	LU	Z	TOT	DB	β°	A	AI	B	C	S/AS	TYPE	MACHINE BRANDS	COD SX / LH	COD DX / RH	PRICES €	COD SX / LH	COD DX / RH	PRICES €
150	43	3+3	18	30	30°	1,5		40	1,5	AS	2	HOMAG	FFD4020045	FFD4020046		FFD4022045	FFD4022046	
150	43	4+4	24	30	30°	1,5		40	1,5	AS	2	HOMAG	FFD4020047	FFD4020048		FFD4022047	FFD4022048	
150	65	3+3	24	30	30°	13,75		40	13,75	AS	2	HOMAG	FFD4020049	FFD4020050		FFD4022049	FFD4022050	
150	65	4+4	32	30	30°	13,75		40	13,75	AS	2	HOMAG	FFD4020051	FFD4020052		FFD4022051	FFD4022052	

FFD4002 - FFD4004 - FFD4006 - FFD4008 - FFD4010 - FFD4012 - FFD4015 - FFD4017 - FFD4021 - FFD4023

FRESE BORDATRICI AD ELICA
IN DIAMANTE PCD H2.5/4.5 MM
ASSIALE 30° CON ASOLE ANTIRUMORE

DIAMOND JOINTING CUTTER PCD
H2.5/4.5 MM AXIAL 30°
WITH LOW NOISE SLOTS

Frese bordatrici per rettifica ad elica in diamante con placchetta H2.5 / 4.5mm, angolo assiale di taglio 30° e asole antirumore.

Diamond jointing cutter D60 PCD H2.5 / 4.5mm axial 30° with low noise slots.

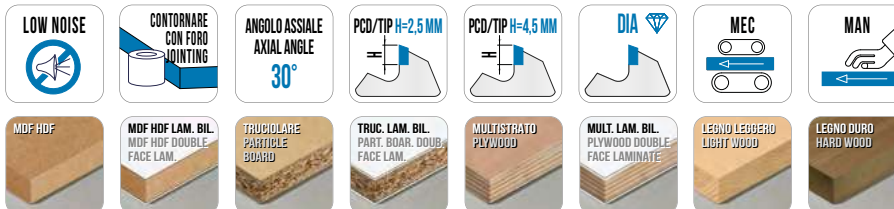
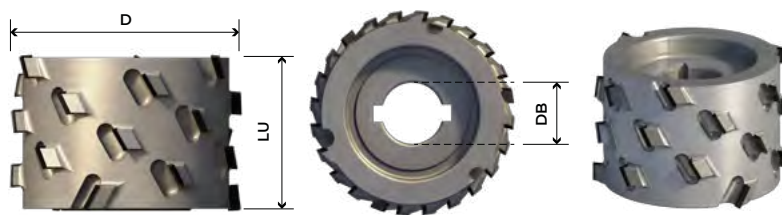

D60		DIMENSIONI DIMENSIONS		MACCHINA		ARTICOLI ITEMS												
		Pag. 232				FFD4002 - H2,5 mm		FFD4004 - H4,5 mm										
D	LU	Z	TOT	DB	β°	A	AI	B	C	S/AS	TYPE	MACHINE BRANDS	COD SX / LH	COD DX / RH	PREZZI €	COD SX / LH	COD DX / RH	PREZZI €
60	36	2+2	8	20	30°	6,5		43,5		AS	6	CEHISA	FFD4002001	FFD4002002		FFD4004001	FFD4004002	
60	36	3+3	12	20	30°	6,5		43,5		AS	6	CEHISA	FFD4002003	FFD4002004		FFD4004003	FFD4004004	
60	48	2+2	12	25	30°					AS	1	FRAVOL	FFD4002005	FFD4002006		FFD4004005	FFD4004006	
60	48	3+3	18	25	30°					AS	1	FRAVOL	FFD4002007	FFD4002008		FFD4004007	FFD4004008	
60	48	2+2	12	25	30°	14				AS	6	FELDER	FFD4002009	FFD4002010		FFD4004009	FFD4004010	
60	48	3+3	18	25	30°	14				AS	6	FELDER	FFD4002011	FFD4002012		FFD4004011	FFD4004012	
60	48	2+2	12	20	30°	7				AS	7		FFD4002013	FFD4002014		FFD4004013	FFD4004014	
60	48	3+3	18	20	30°	7				AS	7		FFD4002015	FFD4002016		FFD4004015	FFD4004016	
60	55	2+2	14	20	30°					AS	1		FFD4002017	FFD4002018		FFD4004017	FFD4004018	
60	55	3+3	21	20	30°					AS	1		FFD4002019	FFD4002020		FFD4004019	FFD4004020	
60	55	2+2	14	25	30°					AS	1		FFD4002021	FFD4002022		FFD4004021	FFD4004022	
60	55	3+3	21	25	30°					AS	1		FFD4002023	FFD4002024		FFD4004023	FFD4004024	
60	55	2+2	14	16	30°	12		31	12	S	2		FFD4002025	FFD4002025		FFD4004025	FFD4004025	
60	55	3+3	21	16	30°	12		31	12	S	2		FFD4002027	FFD4002027		FFD4004027	FFD4004027	
60	55	2+2	14	20	30°	13		43,5		AS	7	CEHISA	FFD4002029	FFD4002030		FFD4004029	FFD4004030	
60	55	3+3	21	20	30°	13		43,5		AS	7	CEHISA	FFD4002031	FFD4002032		FFD4004031	FFD4004032	
60	55	2+2	14	25	30°	3,5		48	3,5	AS	2	CASADEI	FFD4002045	FFD4002046		FFD4004045	FFD4004046	
60	55	3+3	21	25	30°	3,5		48	3,5	AS	2	CASADEI	FFD4002047	FFD4002048		FFD4004047	FFD4004048	
60	65	2+2	16	20	30°					AS	1		FFD4002033	FFD4002034		FFD4004033	FFD4004034	
60	65	3+3	24	20	30°					AS	1		FFD4002035	FFD4002036		FFD4004035	FFD4004036	
60	65	2+2	16	25	30°					AS	1	FELDER FORMAT 4 FRAVOL	FFD4002037	FFD4002038		FFD4004037	FFD4004038	
60	65	3+3	24	25	30°					AS	1	FELDER FORMAT 4 FRAVOL	FFD4002039	FFD4002040		FFD4004039	FFD4004040	
60	65	2+2	16	25	30°	8				AS	7	FRAVOL	FFD4002041	FFD4002042		FFD4004041	FFD4004042	
60	65	3+3	24	25	30°	8				AS	7	FRAVOL	FFD4002043	FFD4002044		FFD4004043	FFD4004044	

D70		DIMENSIONI DIMENSIONS		MACCHINA		ARTICOLI ITEMS												
		Pag. 232				FFD4006 - H2,5 mm		FFD4008 - H4,5 mm										
D	LU	Z	TOT	DB	β°	A	AI	B	C	S/AS	TYPE	MACHINE BRANDS	COD SX / LH	COD DX / RH	PREZZI €	COD SX / LH	COD DX / RH	PREZZI €
70	45	2+2	12	30	30°	16				AS	6		FFD4006001	FFD4006002		FFD4008001	FFD4008002	
70	45	3+3	18	30	30°	16				AS	6		FFD4006003	FFD4006004		FFD4008003	FFD4008004	
70	48	2+2	12	30	30°	9	9	24	6	AS	10	HOLZ-HER	FFD4006005	FFD4006006		FFD4008005	FFD4008006	
70	48	3+3	18	30	30°	9	9	24	6	AS	10	HOLZ-HER	FFD4006007	FFD4006008		FFD4008007	FFD4008008	
70	48	2+2	12	30	30°	9		41	6	AS	5	HOLZ-HER ARCUS 1801	FFD4006009	FFD4006010		FFD4008009	FFD4008010	
70	48	3+3	18	30	30°	9		41	6	AS	5	HOLZ-HER ARCUS 1801	FFD4006011	FFD4006012		FFD4008011	FFD4008012	
70	48	2+2	12	30	30°	8				AS	7		FFD4006013	FFD4006014		FFD4008013	FFD4008014	
70	48	3+3	18	30	30°	8				AS	7		FFD4006015	FFD4006016		FFD4008015	FFD4008016	
70	48	2+2	12	25	30°	12		61		AS	6	HEBROCK	FFD4006017	FFD4006018		FFD4008017	FFD4008018	
70	48	3+3	18	25	30°	12		61		AS	6	HEBROCK	FFD4006019	FFD4006020		FFD4008019	FFD4008020	
70	48	2+2	12	25	30°	11		70	11	AS	3		FFD4006021	FFD4006022		FFD4008021	FFD4008022	
70	48	2+2	18	25	30°	11		70	11	AS	3		FFD4006023	FFD4006024		FFD4008023	FFD4008024	
70	55	2+2	14	30	30°	9,5	9	30,5	6	AS	10	HOLZ-HER AGGREGATE 1801	FFD4006025	FFD4006026		FFD4008025	FFD4008026	
70	55	3+3	21	30	30°	9,5	9	30,5	6	AS	10	HOLZ-HER AGGREGATE 1801	FFD4006027	FFD4006028		FFD4008027	FFD4008028	
70	65	2+2	16	30	30°	9,5	9	40,5	6	AS	10	HOLZ-HER AGGREGATE 1801	FFD4006029	FFD4006030		FFD4008029	FFD4008030	
70	65	3+3	24	30	30°	9,5	9	40,5	6	AS	10	HOLZ-HER AGGREGATE 1801	FFD4006031	FFD4006032		FFD4008031	FFD4008032	

D80

DIMENSIONI		DIMENSIONS		MACCHINA								ARTICOLI ITEMS						
D	LU	Z	Z TOT	DB	β°	A	AI	B	C	S/AS	TYPE	MACHINE BRANDS	FFD4010 - H2,5 mm		PREZZI €	FFD4012 - H4,5 mm		PREZZI €
												Pag. 232	COD SX / LH	COD DX / RH	PRICES €	COD SX / LH	COD DX / RH	PRICES €
80	25	2+2	6	30	30°					AS	1		FFD4010001	FFD4010002		FFD4012001	FFD4012002	
80	25	3+3	9	30	30°					AS	1		FFD4010003	FFD4010004		FFD4012003	FFD4012004	
80	30	2+2	8	30	30°	11,5		53	11,5	S	3	BIESSE AKRON 1300 AKRON 1400 AKRON 400 AKRON 800 ROXYL STREAM A JADE 240	FFD4010005	FFD4010005		FFD4012005	FFD4012005	
80	30	3+3	12	30	30°	11,5		53	11,5	S	3	BIESSE AKRON 1300 AKRON 1400 AKRON 400 AKRON 800 ROXYL STREAM A JADE 240	FFD4010007	FFD4010007		FFD4012007	FFD4012007	
80	40	2+2	10	30	30°					AS	1	SCM	FFD4010009	FFD4010010		FFD4012009	FFD4012010	
80	40	3+3	15	30	30°					AS	1	SCM	FFD4010011	FFD4010012		FFD4012011	FFD4012012	
80	45	2+2	12	30	30°	4		53	4	S	3	BIESSE AKRON 1300 AKRON 1400 AKRON 400 AKRON 800 ROXYL STREAM A JADE 240	FFD4010013	FFD4010014		FFD4012013	FFD4012013	
80	45	3+3	18	30	30°	4		53	4	S	3	BIESSE AKRON 1300 AKRON 1400 AKRON 400 AKRON 800 ROXYL STREAM A JADE 240	FFD4010015	FFD4010015		FFD4012015	FFD4012015	
80	48	2+2	12	30	30°					AS	1		FFD4010017	FFD4010018		FFD4012017	FFD4012018	
80	48	3+3	18	30	30°					AS	1		FFD4010019	FFD4010020		FFD4012019	FFD4012020	
80	48	2+2	12	30	30°	15		63		AS	6	FELDER	FFD4010021	FFD4010022		FFD4012021	FFD4012022	
80	48	3+3	18	30	30°	15		63		AS	6	FELDER	FFD4010023	024FFD4010		FFD4012023	FFD4012024	
80	48	2+2	12	20	30°	11,5		25	11,5	S	2	BIESSE AKRON 246	FFD4010025	FFD4010025		FFD4012025	FFD4012025	
80	48	3+3	18	20	30°	11,5		25	11,5	S	2	BIESSE AKRON 246	FFD4010027	FFD4010027		FFD4012027	FFD4012027	
80	55	2+2	14	30	30°					AS	1	SCM ME 35 MINIMAX	FFD4010029	FFD4010030		FFD4012029	FFD4012030	
80	55	3+3	21	30	30°					AS	1	SCM ME 35 MINIMAX	FFD4010031	FFD4010032		FFD4012031	FFD4012032	
80	55	2+2	14	20	30°	17		25	13	AS	2	BIESSE AKRON 246 GRIGGIO	FFD4010033	FFD4010034		FFD4012033	FFD4012034	
80	55	3+3	21	20	30°	17		25	13	AS	2	BIESSE AKRON 246 GRIGGIO	FFD4010035	FFD4010036		FFD4012035	FFD4012036	
80	65	2+2	16	25	30°					AS	1		FFD4010037	038FFD4010		FFD4012037	FFD4012038	
80	65	3+3	24	25	30°					AS	1		FFD4010039	FFD4010040		FFD4012039	FFD4012040	
80	65	2+2	16	30	30°	6		53	6	S	2	BIESSE AKRON 1300 AKRON 1400 AKRON 400 AKRON 800 ROXYL STREAM A JADE 240	FFD4010041	FFD4010041		FFD4012041	FFD4012041	
80	65	3+3	24	30	30°	6		53	6	S	2	BIESSE AKRON 1300 AKRON 1400 AKRON 400 AKRON 800 ROXYL STREAM A JADE 240	FFD4010043	FFD4010043		FFD4012043	FFD4012043	
80	65	2+2	16	30	30°	10		56		AS	7		FFD4010045	FFD4010046		FFD4012045	FFD4012046	
80	65	3+3	24	30	30°	10		56		AS	7		FFD4010047	FFD4010048		FFD4012047	FFD4012048	
80	65	2+2	16	30	30°	28		25	12	AS	2	GRIGGIO	FFD4010049	FFD4010050		FFD4012049	FFD4012050	
80	65	3+3	24	30	30°	28		25	12	AS	2	GRIGGIO	FFD4010051	FFD4010052		FFD4012051	FFD4012052	
80	65	2+2	16	20	30°	21,5		37	6,5	AS	2	CEHISA	FFD4010053	FFD4010054		FFD4012053	FFD4012054	
80	65	3+3	24	20	30°	21,5		37	6,5	AS	2	CEHISA	FFD4010055	FFD4010056		FFD4012055	FFD4012056	

D85

DIMENSIONI		DIMENSIONS		MACCHINA								ARTICOLI ITEMS						
D	LU	Z	Z TOT	DB	β°	A	AI	B	C	S/AS	TYPE	MACHINE BRANDS	FFD4010 - H2,5 mm		PREZZI €	FFD4012 - H4,5 mm		PREZZI €
												Pag. 232	COD SX / LH	COD DX / RH	PRICES €	COD SX / LH	COD DX / RH	PRICES €
85	45	3+3	24	30	30°					AS	1	OTT	FFD4010057	FFD4010058		FFD4012057	FFD4012058	
85	65	3+3	24	30	30°	15				AS	7	OTT	FFD4010059	FFD4010060		FFD4012-059	FFD4012060	



D	LU	Z	Z TOT	DB	β°	A	AI	B	C	S/AS	TYPE	MACHINE BRANDS	COD SX / LH	COD DX / RH	PRICES €	COD SX / LH	COD DX / RH	PRICES €
100	35	2+2	8	30	30°					AS	1	IMA - BRANDT	FFD4015001	FFD4015002		FFD4017001	FFD4017002	
100	35	3+3	12	30	30°					AS	1	IMA - BRANDT	FFD4015003	FFD4015004		FFD4017003	FFD4017004	
100	45	2+2	12	30	30°					AS	1		FFD4015005	FFD4015006		FFD4017005	FFD4017006	
100	45	3+3	18	30	30°					AS	1		FFD4015007	FFD4015008		FFD4017007	FFD4017008	
100	45	2+2	12	30	30°					S	1		FFD4015009	FFD4015009		FFD4017009	FFD4017009	
100	45	3+3	18	30	30°					S	1		FFD4015011	FFD4015011		FFD4017011	FFD4017011	
100	45	2+2	12	30	30°	5,4		40,6		AS	7	BRANDT	FFD4015013	FFD4015014		FFD4017013	FFD4017014	
100	45	3+3	18	30	30°	5,4		40,6		AS	7	BRANDT	FFD4015015	FFD4015016		FFD4017015	FFD4017016	
100	45	2+2	12	30	30°	16		61		AS	6	HEBROCK EBM - BRANDT AMBITION 1110 F	FFD4015017	FFD4015018		FFD4017017	FFD4017018	
100	45	3+3	18	30	30°	16		61		AS	6	HEBROCK EBM - BRANDT AMBITION 1110 F	FFD4015019	FFD4015020		FFD4017019	FFD4017020	
100	45	2+2	12	30	30°	12		75	15	AS	3		FFD4015021	FFD4015022		FFD4017021	FFD4017022	
100	45	3+3	18	30	30°	12		75	15	AS	3		FFD4015023	FFD4015024		FFD4017023	FFD4017024	
100	48	2+2	12	25	30°					AS	1		FFD4015025	FFD4015026		FFD4017025	FFD4017026	
100	48	3+3	18	25	30°					AS	1		FFD4015027	FFD4015028		FFD4017027	FFD4017028	
100	48	2+2	12	30	30°	11,5		25	11,5	AS	2	HOLZ - SCM HER UP TO 2008	FFD4015029	FFD4015030		FFD4017029	FFD4017030	
100	48	3+3	18	30	30°	11,5		25	11,5	AS	2	HOLZ - SCM HER UP TO 2008	FFD4015031	FFD4015032		FFD4017031	FFD4017032	
100	48	2+2	12	30	30°	7,4		40,6		AS	7	BRANDT - IMA SCM K360 K560 IDM - BIESSE	FFD4015033	FFD4015034		FFD4017033	FFD4017034	
100	48	3+3	18	30	30°	7,4		40,6		AS	7	BRANDT - IMA SCM K360 K560 IDM - BIESSE	FFD4015035	FFD4015036		FFD4017035	FFD4017036	
100	48	2+2	12	30	30°	4		40	4	AS	2	BRANDT - IMA SCM K360 K560 IDM - BIESSE	FFD4015037	FFD4015038		FFD4017037	FFD4017038	
100	48	3+3	18	30	30°	4		40	4	AS	2	BRANDT - IMA SCM K360 K560 IDM - BIESSE	FFD4015039	FFD4015040		FFD4017039	FFD4017040	
100	55	2+2	14	30	30°					AS	1		FFD4015041	FFD4015042		FFD4017041	FFD4017042	
100	55	3+3	21	30	30°					AS	1		FFD4015043	FFD4015044		FFD4017043	FFD4017044	
100	55	2+2	14	30	30°	18,5		25	11,5	AS	2	HOLZ - SCM HER UP TO 2008	FFD4015045	FFD4015046		FFD4017045	FFD4017046	
100	55	3+3	21	30	30°	18,5		25	11,5	AS	2	HOLZ - SCM HER UP TO 2008	FFD4015047	FFD4015048		FFD4017047	FFD4017048	
100	55	2+2	14	30	30°	14,4		40,6		AS	7	BRANDT - IMA SCM K360 K560 IDM - BIESSE	FFD4015049	FFD4015050		FFD4017049	FFD4017050	
100	55	3+3	21	30	30°	14,4		40,6		AS	7	BRANDT - IMA SCM K360 K560 IDM - BIESSE	FFD4015051	FFD4015052		FFD4017051	FFD4017052	
100	65	2+2	16	30	30°					AS	1		FFD4015053	FFD4015054		FFD4017053	FFD4017054	
100	65	3+3	24	30	30°					AS	1		FFD4015055	FFD4015056		FFD4017055	FFD4017056	
100	65	2+2	16	30	30°	5		75	5	S	3	BIESSE AKRON 600 AKRON 800	FFD4015057	FFD4015057		FFD4017057	FFD4017057	
100	65	3+3	24	30	30°	5		75	5	S	3	BIESSE AKRON 600 AKRON 800	FFD4015059	FFD4015059		FFD4017059	FFD4017059	
100	65	2+2	16	30	30°	25,4		40,6		AS	7	BRANDT - IMA SCM K360 K560 IDM - BIESSE	FFD4015061	FFD4015062		FFD4017061	FFD4017062	
100	65	3+3	24	30	30°	25,4		40,6		AS	7	BRANDT - IMA SCM K360 K560 IDM - BIESSE	FFD4015063	FFD4015064		FFD4017063	FFD4017064	
100	65	2+2	16	30	30°	12		26	27	AS	2	HOLZ - SCM HER UP TO 2008	FFD4015065	FFD4015066		FFD4017065	FFD4017066	
100	65	3+3	24	30	30°	12		26	27	AS	2	HOLZ - SCM HER UP TO 2008	FFD4015067	FFD4015068		FFD4017067	FFD4017068	
100	65	2+2	16	20	30°	21,5		37	6,5	AS	2	CEHISA	FFD4015069	FFD4015070		FFD4017069	FFD4017070	
100	65	3+3	24	20	30°	21,5		37	6,5	AS	2	CEHISA	FFD4015071	FFD4015072		FFD4017071	FFD4017072	
100	65	2+2	16	30	30°	16		40	9	AS	2	HOLZ-HER	FFD4015073	FFD4015074		FFD4017073	FFD4017074	
100	65	3+3	24	30	30°	16		40	9	AS	2	HOLZ-HER	FFD4015075	FFD4015076		FFD4017075	FFD4017076	
100	65	2+2	16	30	30°	16		40	9	S	2	HOLZ-HER	FFD4015077	FFD4015078		FFD4017077	FFD4017078	
100	65	3+3	24	30	30°	16		40	9	S	2	HOLZ-HER	FFD4015079	FFD4015080		FFD4017079	FFD4017080	

D125

DIMENSIONI DIMENSIONS

MACCHINA

ARTICOLI ITEMS

Pag. 232											FFD4021 - H2,5 mm		PREZZI €	FFD4023 - H4,5 mm		PREZZI €		
D	LU	Z	Z TOT	DB	β°	A	AI	B	C	S/AS	TYPE	MACHINE BRANDS	COD SX / LH	COD DX / RH	PRICES €	COD SX / LH	COD DX / RH	PRICES €
125	34	3+3	12	30	30°					AS	1	IMA /HOMAG	FFD4021001	FFD4021002		FFD4023001	FFD4023002	
125	34	4+4	16	30	30°					AS	1	IMA /HOMAG	FFD4021003	FFD4021004		FFD4023003	FFD4023004	
125	43	3+3	18	30	30°	14		57		AS	6		FFD4021005	FFD4021006		FFD4023005	FFD4023006	
125	43	4+4	24	30	30°	14		57		AS	6		FFD4021007	FFD4021008		FFD4023007	FFD4023008	
125	45	3+3	18	30	30°					AS	1	IMA	FFD4021009	FFD4021010		FFD4023009	FFD4023010	
125	45	4+4	24	30	30°					AS	1	IMA	FFD4021011	FFD4021012		FFD4023011	FFD4023012	
125	45	3+3	18	30	30°	6				AS	7	HOMAG	FFD4021013	FFD4021014		FFD4023013	FFD4023014	
125	45	4+4	24	30	30°	6				AS	7	HOMAG	FFD4021015	FFD4021016		FFD4023015	FFD4023016	
125	48	3+3	18	30	30°					AS	1		FFD4021017	FFD4021018		FFD4023017	FFD4023018	
125	48	4+4	24	30	30°					AS	1		FFD4021019	FFD4021020		FFD4023019	FFD4023020	
125	48	3+3	18	30	30°	4		40	4	AS	2	HOMAG	FFD4021021	FFD4021022		FFD4023021	FFD4023022	
125	48	4+4	24	30	30°	4		40	4	AS	2	HOMAG	FFD4021023	FFD4021024		FFD4023023	FFD4023024	
125	65	3+3	24	30	30°					AS	1		FFD4021025	FFD4021026		FFD4023025	FFD4023026	
125	65	4+4	32	30	30°					AS	1		FFD4021027	FFD4021028		FFD4023027	FFD4023028	
125	65	3+3	24	30	30°	8		49	8	AS	2	BIESSE	FFD4021029	FFD4021030		FFD4023029	FFD4023030	
125	65	4+4	32	30	30°	8		49	8	AS	2	BIESSE	FFD4021031	FFD4021032		FFD4023031	FFD4023032	
125	65	3+3	24	30	30°	25,4		40,6		AS	7	BRANDT-IMA-SCM IDM - BIESSE	FFD4021033	FFD4021034		FFD4023033	FFD4023034	
125	65	4+4	32	30	30°	25,4		40,6		AS	7	BRANDT-IMA-SCM IDM - BIESSE	FFD4021035	FFD4021036		FFD4023035	FFD4023036	
125	65	3+3	24	30	30°	12,5		40	12,5	AS	2	HOMAG	FFD4021037	FFD4021038		FFD4023037	FFD4023038	
125	65	4+4	32	30	30°	12,5		40	12,5	AS	2	HOMAG	FFD4021039	FFD4021040		FFD4023039	FFD4023040	
125	65	3+3	24	30	30°	28		25	12	AS	2	GRIGGIO/HOLZ-HER	FFD4021041	FFD4021042		FFD4023041	FFD4023042	
125	65	4+4	32	30	30°	28		25	12	AS	2	GRIGGIO/HOLZ-HER	FFD4021043	FFD4021044		FFD4023043	FFD4023044	

D150

DIMENSIONI DIMENSIONS

MACCHINA

ARTICOLI ITEMS

Pag. 232											FFD4021 - H2,5 mm		PREZZI €	FFD4023 - H4,5 mm		PREZZI €		
D	LU	Z	Z TOT	DB	β°	A	AI	B	C	S/AS	TYPE	MACHINE BRANDS	COD SX / LH	COD DX / RH	PRICES €	COD SX / LH	COD DX / RH	PRICES €
150	43	3+3	18	30	30°	1,5		40	1,5	AS	2	HOMAG	FFD4021045	FFD4021046		FFD4023045	FFD4023046	
150	43	4+4	24	30	30°	1,5		40	1,5	AS	2	HOMAG	FFD4021047	FFD4021048		FFD4023047	FFD4023048	
150	65	3+3	24	30	30°	13,75		40	13,75	AS	2	HOMAG	FFD4021049	FFD4021050		FFD4023049	FFD4023050	
150	65	4+4	32	30	30°	13,75		40	13,75	AS	2	HOMAG	FFD4021051	FFD4021052		FFD4023051	FFD4023052	

FFD4013 - FFD4018 - FFD4024

FRESE BORDATRICI AD ELICA
IN DIAMANTE PCD H4.5 MM
ASSIALE 45°

DIAMOND JOINTING CUTTER
WITH HELICOIDAL WINGS PCD H4.5 MM
AXIAL 45°

Frese bordatrici per rettifica ad elica in diamante con placchetta H4.5 mm, angolo assiale di taglio 45°.

Diamond jointing cutter with helicoidal wings D80/85 PCD H4.5 mm axial 45°.

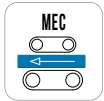
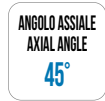
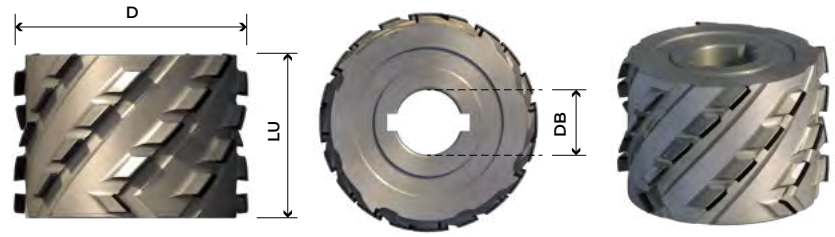

D80				DIMENSIONI DIMENSIONS				MACCHINA				ARTICOLI ITEMS		PREZZI €	
D	LU	Z	Z TOT	DB	β° AXIAL ANGLE	A	AI	B	C	S/AS	TYPE	MACHINE BRANDS	COD SX / LH	COD DX / RH	PRICES €
80	25	2+2	8	30	45°					AS	1		FFD4013001	FFD4013002	
80	25	3+3	12	30	45°					AS	1		FFD4013003	FFD4013004	
80	30	2+2	10	30	45°	11,5		53	11,5	S	3	BIESSE - AKRON 1300 AKRON 1400 - AKRON 400 - AKRON 800 ROXYL - STREAM A JADE 240	FFD4013005	FFD4013005	
80	30	3+3	15	30	45°	11,5		53	11,5	S	3	BIESSE - AKRON 1300 AKRON 1400 - AKRON 400 - AKRON 800 ROXYL - STREAM A JADE 240	FFD4013007	FFD4013007	
80	40	2+2	14	30	45°					AS	1	SCM	FFD4013009	FFD4013010	
80	40	3+3	21	30	45°					AS	1	SCM	FFD4013011	FFD4013012	
80	45	2+2	16	30	45°	4		53	4	S	3	BIESSE - AKRON 1300 AKRON 1400 - AKRON 400 - AKRON 800 ROXYL - STREAM A JADE 240	FFD4013013	FFD4013013	
80	45	3+3	24	30	45°	4		53	4	S	3	BIESSE - AKRON 1300 AKRON 1400 - AKRON 400 - AKRON 800 ROXYL - STREAM A JADE 240	FFD4013015	FFD4013015	
80	48	2+2	16	30	45°					AS	1		FFD4013017	FFD4013018	
80	48	3+3	24	30	45°					AS	1		FFD4013019	FFD4013020	
80	48	2+2	16	25	45°	15		63		AS	6	FELDER	FFD4013021	FFD4013022	
80	48	3+3	24	25	45°	15		63		AS	6	FELDER	FFD4013023	FFD4013024	
80	48	2+2	16	20	45°	11,5		25	11,5	S	2	BIESSE AKRON 246	FFD4013025	FFD4013025	
80	48	3+3	24	20	45°	11,5		25	11,5	S	2	BIESSE AKRON 246	FFD4013027	FFD4013027	
80	55	2+2	18	30	45°					AS	1	SCM ME-35 MINIMAX	FFD4013029	FFD4013030	
80	55	3+3	27	30	45°					AS	1	SCM ME-35 MINIMAX	FFD4013031	FFD4013032	
80	55	2+2	18	20	45°	17		25	13	AS	2	BIESSE AKRON 246 GRIGGIO	FFD4013033	FFD4013034	
80	55	3+3	27	20	45°	17		25	13	AS	2	BIESSE AKRON 246 GRIGGIO	FFD4013035	FFD4013036	
80	65	2+2	18	25	45°					AS	1		FFD4013037	FFD4013038	
80	65	3+3	27	25	45°					AS	1		FFD4013039	FFD4013040	
80	65	2+2	16	30	45°	6		53	6	S	2	BIESSE - AKRON 1300 AKRON 1400 - AKRON 400 - AKRON 800 ROXYL - STREAM A JADE 240	FFD4013041	FFD4013041	
80	65	3+3	24	30	45°	6		53	6	S	2	BIESSE - AKRON 1300 AKRON 1400 - AKRON 400 - AKRON 800 ROXYL - STREAM A JADE 240	FFD4013043	FFD4013043	
80	65	2+2	18	30	45°	10		56		AS	7		FFD4013045	FFD4013046	
80	65	3+3	27	30	45°	10		56		AS	7		FFD4013047	FFD4013048	
80	65	2+2	18	30	45°	28		25	12	AS	2	GRIGGIO	FFD4013049	FFD4013050	
80	65	3+3	27	30	45°	28		25	12	AS	2	GRIGGIO	FFD4013051	FFD4013052	
80	65	2+2	18	20	45°	21,5		37	6,5	AS	2	CEHISA	FFD4013053	FFD4013054	
80	65	3+3	27	20	45°	21,5		37	6,5	AS	2	CEHISA	FFD4013055	FFD4013056	

D85

DIMENSIONI DIMENSIONS

MACCHINA

ARTICOLI ITEMS

PREZZI €

D		LU		Z	Z TOT	DB	β° AXIAL ANGLE	A	AI	B	C	S/AS	TYPE	MACHINE BRANDS	FFD4013 - H4,5 mm		PRICES €
														COD SX / LH	COD DX / RH		
85	45	3+3	24	30	45°							AS	1	OTT	FFD4013057	FFD4013058	
85	65	3+3	27	30	45°	15						AS	7	OTT	FFD4013059	FFD4013060	

D100

DIMENSIONI DIMENSIONS

MACCHINA

ARTICOLI ITEMS

PREZZI €

D		LU		Z	Z TOT	DB	β° AXIAL ANGLE	A	AI	B	C	S/AS	TYPE	MACHINE BRANDS	FFD4018 - H4,5 mm		PRICES €
														COD SX / LH	COD DX / RH		
100	35	2+2	12	30	45°							AS	1	IMA - BRANDT	FFD4018001	FFD4018002	
100	35	3+3	18	30	45°							AS	1	IMA - BRANDT	FFD4018003	FFD4018004	
100	45	2+2	16	30	45°							AS	1		FFD4018005	FFD4018006	
100	45	3+3	24	30	45°							AS	1		FFD4018007	FFD4018008	
100	45	2+2	16	30	45°							S	1		FFD4018009	FFD4018009	
100	45	3+3	24	30	45°							S	1		FFD4018011	FFD4018011	
100	45	2+2	16	30	45°	5,4		40,6				AS	7	BRANDT	FFD4018013	FFD4018014	
100	45	3+3	24	30	45°	5,4		40,6				AS	7	BRANDT	FFD4018015	FFD4018016	
100	45	2+2	16	30	45°	16		61				AS	6	HEBROCK - EBM BRANDT AMBITION 1110 F	FFD4018017	FFD4018018	
100	45	3+3	24	30	45°	16		61				AS	6	HEBROCK - EBM BRANDT AMBITION 1110 F	FFD4018019	FFD4018020	
100	45	2+2	16	30	45°	12		75	15			AS	3		FFD4018021	FFD4018022	
100	45	3+3	24	30	45°	12		75	15			AS	3		FFD4018023	FFD4018024	
100	48	2+2	16	25	45°							AS	1		FFD4018025	FFD4018026	
100	48	3+3	24	25	45°							AS	1		FFD4018027	FFD4018028	
100	48	2+2	16	30	45°	11,5		25	11,5			AS	2	HOLZ - SCM HER UP TO 2008	FFD4018029	FFD4018030	
100	48	3+3	24	30	45°	11,5		25	11,5			AS	2	HOLZ - SCM HER UP TO 2008	FFD4018031	FFD4018032	
100	48	2+2	16	30	45°	7,4		40,6				AS	7	BRANDT - IMA SCM K360 K560 IDM - BIESSE	FFD4018033	FFD4018034	
100	48	3+3	24	30	45°	7,4		40,6				AS	7	BRANDT - IMA SCM K360 K560 IDM - BIESSE	FFD4018035	FFD4018036	
100	48	2+2	16	30	45°	4		40	4			AS	2	BRANDT - IMA SCM K360 K560 IDM - BIESSE	FFD4018037	FFD4018038	
100	48	3+3	24	30	45°	4		40	4			AS	2	BRANDT - IMA SCM K360 K560 IDM - BIESSE	FFD4018039	FFD4018040	
100	55	2+2	18	30	45°							AS	1		FFD4018041	FFD4018042	
100	55	3+3	27	30	45°							AS	1		FFD4018043	FFD4018044	
100	55	2+2	18	30	45°	18,5		25	11,5			AS	2	HOLZ - SCM HER UP TO 2008	FFD4018045	FFD4018046	
100	55	3+3	27	30	45°	18,5		25	11,5			AS	2	HOLZ - SCM HER UP TO 2008	FFD4018047	FFD4018048	
100	55	2+2	18	30	45°	14,4		40,6				AS	7	BRANDT - IMA SCM K360 K560 IDM - BIESSE	FFD4018049	FFD4018050	
100	55	3+3	27	30	45°	14,4		40,6				AS	7	BRANDT - IMA SCM K360 K560 IDM - BIESSE	FFD4018051	FFD4018052	
100	65	2+2	18	30	45°							AS	1		FFD4018053	FFD4018054	
100	65	3+3	27	30	45°							AS	1		FFD4018055	FFD4018056	
100	65	2+2	18	30	45°	5		75	5			S	3	BIESSE - AKRON 600 AKRON 800	FFD4018057	FFD4018057	
100	65	3+3	27	30	45°	5		75	5			S	3	BIESSE - AKRON 600 AKRON 800	FFD4018059	FFD4018059	
100	65	2+2	18	30	45°	25,4		40,6				AS	7	BRANDT - IMA SCM K360 K560 IDM - BIESSE	FFD4018061	FFD4018062	
100	65	3+3	27	30	45°	25,4		40,6				AS	7	BRANDT - IMA SCM K360 K560 IDM - BIESSE	FFD4018063	FFD4018064	
100	65	2+2	18	30	45°	12		26	27			AS	2	HOLZ - SCM HER UP TO 2008	FFD4018065	FFD4018066	
100	65	3+3	27	30	45°	12		26	27			AS	2	HOLZ - SCM HER UP TO 2008	FFD4018067	FFD4018068	
100	65	2+2	18	20	45°	21,5		37	6,5			AS	2	CEHISA	FFD4018069	FFD4018070	
100	65	3+3	27	20	45°	21,5		37	6,5			AS	2	CEHISA	FFD4018071	FFD4018072	
100	65	2+2	18	30	45°	16		40	9			AS	2	HOLZ-HER	FFD4018073	FFD4018074	
100	65	3+3	27	30	45°	16		40	9			AS	2	HOLZ-HER	FFD4018075	FFD4018076	
100	65	2+2	18	30	45°	16		40	9			S	2	HOLZ-HER	FFD4018077	FFD4018078	
100	65	3+3	27	30	45°	16		40	9			S	2	HOLZ-HER	FFD4018079	FFD4018080	

D125

DIMENSIONI		DIMENSIONS		MACCHINA								ARTICOLI ITEMS		PREZZI €	
D	LU	Z	Z TOT	DB	β° AXIAL ANGLE	A	AI	B	C	S/AS	TYPE	MACHINE BRANDS	COD SX / LH	COD DX / RH	PRICES €
Pag. 232															
FFD4024 - H4,5 mm															
125	34	3+3	18	30	45°					AS	1	IMA /HOMAG	FFD4024001	FFD4024002	
125	34	4+4	24	30	45°					AS	1	IMA /HOMAG	FFD4024003	FFD4024004	
125	43	3+3	24	30	45°	14		57		AS	6		FFD4024005	FFD4024006	
125	43	4+4	32	30	45°	14		57		AS	6		FFD4024007	FFD4024008	
125	45	3+3	24	30	45°					AS	1	IMA	FFD4024009	FFD4024010	
125	45	4+4	32	30	45°					AS	1	IMA	FFD4024011	FFD4024012	
125	45	3+3	24	30	45°	6				AS	7	HOMAG	FFD4024013	FFD4024014	
125	45	4+4	32	30	45°	6				AS	7	HOMAG	FFD4024015	FFD4024016	
125	48	3+3	24	30	45°					AS	1		FFD4024017	FFD4024018	
125	48	4+4	32	30	45°					AS	1		FFD4024019	FFD4024020	
125	48	3+3	24	30	45°	4		40	4	AS	2	HOMAG	FFD4024021	FFD4024022	
125	48	4+4	32	30	45°	4		40	4	AS	2	HOMAG	FFD4024023	FFD4024024	
125	65	3+3	27	30	45°					AS	1		FFD4024025	FFD4024026	
125	65	4+4	36	30	45°					AS	1		FFD4024027	FFD4024028	
125	65	3+3	27	30	45°	8		49	8	AS	2	BIESSE	FFD4024029	FFD4024030	
125	65	4+4	36	30	45°	8		49	8	AS	2	BIESSE	FFD4024031	FFD4024032	
125	65	3+3	27	30	45°	25,4		40,6		AS	7	BRANDT-IMA-SCM IDM - BIESSE	FFD4024033	FFD4024034	
125	65	4+4	36	30	45°	25,4		40,6		AS	7	BRANDT-IMA-SCM IDM - BIESSE	FFD4024035	FFD4024036	
125	65	3+3	27	30	45°	12,5		40	12,5	AS	2	HOMAG	FFD4024037	FFD4024038	
125	65	4+4	36	30	45°	12,5		40	12,5	AS	2	HOMAG	FFD4024039	FFD4024040	
125	65	3+3	27	30	45°	28		25	12	AS	2	GRIGGIO/HOLZ-HER	FFD4024041	FFD4024042	
125	65	4+4	36	30	45°	28		25	12	AS	2	GRIGGIO/HOLZ-HER	FFD4024043	FFD4024044	

D150

DIMENSIONI		DIMENSIONS		MACCHINA								ARTICOLI ITEMS		PREZZI €	
D	LU	Z	Z TOT	DB	β° AXIAL ANGLE	A	AI	B	C	S/AS	TYPE	MACHINE BRANDS	COD SX / LH	COD DX / RH	PRICES €
Pag. 232															
FFD4024 - H4,5 mm															
150	43	3+3	24	30	45°	1,5		40	1,5	AS	2	HOMAG	FFD4024045	FFD4024046	
150	43	4+4	32	30	45°	1,5		40	1,5	AS	2	HOMAG	FFD4024047	FFD4024048	
150	65	3+3	24	30	45°	13,75		40	13,75	AS	2	HOMAG	FFD4024049	FFD4024050	
150	65	4+4	32	30	45°	13,75		40	13,75	AS	2	HOMAG	FFD4024051	FFD4024052	

FFD4019 - FFD4025

FRESE BORDATRICI AD ELICA
IN DIAMANTE PCD H4.5 MM
ASSIALE 54.9°

DIAMOND JOINTING CUTTER
WITH HELICOIDAL WINGS PCD H4.5 MM
AXIAL 54.9°

Frese bordatrici per rettifica ad elica in
diamante con placchetta H4.5 mm, angolo
assiale di taglio 54.9°.

Diamond jointing cutter with helicoidal
wings D100 PCD H4.5 mm axial 54.9°.

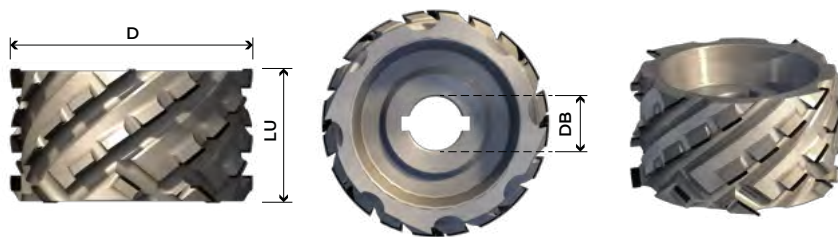

D100

DIMENSIONI DIMENSIONS

MACCHINA

ARTICOLI ITEMS

PREZZI €

Pag. 232											FFD4019 - H4,5 mm		PRICES €		
D	LU	Z	Z TOT	DB	β° AXIAL ANGLE	A	AI	B	C	S/AS	TYPE	MACHINE BRANDS		COD SX / LH	COD DX / RH
100	35	2+2	10	30	54,9°					AS	1	IMA - BRANDT	FFD4019001	FFD4019002	
100	35	3+3	15	30	54,9°					AS	1	IMA - BRANDT	FFD4019003	FFD4019004	
100	45	2+2	14	30	54,9°					AS	1		FFD4019005	FFD4019006	
100	45	3+3	21	30	54,9°					AS	1		FFD4019007	FFD4019008	
100	45	2+2	14	30	54,9°					S	1		FFD4019009	FFD4019009	
100	45	3+3	21	30	54,9°					S	1		FFD4019011	FFD4019011	
100	45	2+2	14	30	54,9°	5,4		40,6		AS	7	BRANDT	FFD4019013	FFD4019014	
100	45	3+3	21	30	54,9°	5,4		40,6		AS	7	BRANDT	FFD4019015	FFD4019016	
100	45	2+2	14	30	54,9°	16		61		AS	6	HEBROCK - EBM BRANDT AMBITION 1110 F	FFD4019017	FFD4019018	
100	45	3+3	21	30	54,9°	16		61		AS	6	HEBROCK - EBM BRANDT AMBITION 1110 F	FFD4019019	FFD4019020	
100	45	2+2	14	30	54,9°	12		75	15	AS	3		FFD4019021	FFD4019022	
100	45	3+3	21	30	54,9°	12		75	15	AS	3		FFD4019023	FFD4019024	
100	48	2+2	14	25	54,9°					AS	1		FFD4019025	FFD4019026	
100	48	3+3	21	25	54,9°					AS	1		FFD4019027	FFD4019028	
100	48	2+2	14	30	54,9°	11,5		25	11,5	AS	2	HOLZ - SCM HER UP TO 2008	FFD4019029	FFD4019030	
100	48	3+3	21	30	54,9°	11,5		25	11,5	AS	2	HOLZ - SCM HER UP TO 2008	FFD4019031	FFD4019032	
100	48	2+2	14	30	54,9°	7,4		40,6		AS	7	BRANDT - IMA SCM K360 K560 IDM - BIESSE	FFD4019033	FFD4019034	
100	48	3+3	21	30	54,9°	7,4		40,6		AS	7	BRANDT - IMA SCM K360 K560 IDM - BIESSE	FFD4019035	FFD4019036	
100	48	2+2	14	30	54,9°	4		40	4	AS	2	BRANDT - IMA SCM K360 K560 IDM - BIESSE	FFD4019037	FFD4019038	
100	48	3+3	21	30	54,9°	4		40	4	AS	2	BRANDT - IMA SCM K360 K560 IDM - BIESSE	FFD4019039	FFD4019040	
100	55	2+2	16	30	54,9°					AS	1		FFD4019041	FFD4019042	
100	55	3+3	24	30	54,9°					AS	1		FFD4019043	FFD4019044	
100	55	2+2	16	30	54,9°	18,5		25	11,5	AS	2	HOLZ - SCM HER UP TO 2008	FFD4019045	FFD4019046	
100	55	3+3	24	30	54,9°	18,5		25	11,5	AS	2	HOLZ - SCM HER UP TO 2008	FFD4019047	FFD4019048	
100	55	2+2	16	30	54,9°	14,4		40,6		AS	7	BRANDT - IMA SCM IDM - BIESSE	FFD4019049	FFD4019050	
100	55	3+3	24	30	54,9°	14,4		40,6		AS	7	BRANDT - IMA SCM IDM - BIESSE	FFD4019051	FFD4019052	
100	65	2+2	16	30	54,9°					AS	1		FFD4019053	FFD4019054	
100	65	3+3	24	30	54,9°					AS	1		FFD4019055	FFD4019056	
100	65	2+2	16	30	54,9°	5		75	5	S	3	BIESSE AKRON 600 AKRON 800	FFD4019057	FFD4019057	
100	65	3+3	24	30	54,9°	5		75	5	S	3	BIESSE AKRON 600 AKRON 800	FFD4019059	FFD4019059	
100	65	2+2	16	30	54,9°	25,4		40,6		AS	7	BRANDT - IMA SCM K360 K560 IDM - BIESSE	FFD4019061	FFD4019062	

D100				DIMENSIONI DIMENSIONS		MACCHINA		ARTICOLI ITEMS		PREZZI €					
				Pag. 232		FFD4019 - H4,5 mm									
D	LU	Z	Z TOT	DB	β° AXIAL ANGLE	A	AI	B	C	S/AS	TYPE	MACHINE BRANDS	COD SX / LH	COD DX / RH	PRICES €
100	65	3+3	24	30	54,9°	25,4		40,6		AS	7	BRANDT - IMA SCM K360 K560 IDM - BIESSE	FFD4019063	FFD4019064	
100	65	2+2	16	30	54,9°	12		26	27	AS	2	HOLZ - SCM HER UP TO 2008	FFD4019065	FFD4019066	
100	65	3+3	24	30	54,9°	12		26	27	AS	2	HOLZ - SCM HER UP TO 2008	FFD4019067	FFD4019068	
100	65	2+2	16	20	54,9°	21,5		37	6,5	AS	2	CEHISA	FFD4019069	FFD4019070	
100	65	3+3	24	20	54,9°	21,5		37	6,5	AS	2	CEHISA	FFD4019071	FFD4019072	
100	65	2+2	16	30	54,9°	16		40	9	AS	2	HOLZ-HER	FFD4019073	FFD4019074	
100	65	3+3	24	30	54,9°	16		40	9	AS	2	HOLZ-HER	FFD4019075	FFD4019076	
100	65	2+2	16	30	54,9°	16		40	9	S	2	HOLZ-HER	FFD4019077	FFD4019078	
100	65	3+3	24	30	54,9°	16		40	9	S	2	HOLZ-HER	FFD4019079	FFD4019080	

D125				DIMENSIONI DIMENSIONS		MACCHINA		ARTICOLI ITEMS		PREZZI €					
				Pag. 232		FFD4025 - H4,5 mm									
D	LU	Z	Z TOT	DB	β° AXIAL ANGLE	A	AI	B	C	S/AS	TYPE	MACHINE BRANDS	COD SX / LH	COD DX / RH	PRICES €
125	34	3+3	15	30	54,9°					AS	1	IMA - HOMAG	FFD4025001	FFD4025002	
125	34	4+4	20	30	54,9°					AS	1	IMA - HOMAG	FFD4025003	FFD4025004	
125	43	3+3	21	30	54,9°	14		57		AS	6		FFD4025005	FFD4025006	
125	43	4+4	28	30	54,9°	14		57		AS	6		FFD4025007	FFD4025008	
125	45	3+3	21	30	54,9°					AS	1	IMA	FFD4025009	FFD4025010	
125	45	4+4	28	30	54,9°					AS	1	IMA	FFD4025011	FFD4025012	
125	45	3+3	21	30	54,9°	6				AS	7	HOMAG	FFD4025013	FFD4025014	
125	45	4+4	28	30	54,9°	6				AS	7	HOMAG	FFD4025015	FFD4025016	
125	48	3+3	21	30	54,9°					AS	1		FFD4025017	FFD4025018	
125	48	4+4	28	30	54,9°					AS	1		FFD4025019	FFD4025020	
125	48	3+3	21	30	54,9°	4		40	4	AS	2	HOMAG	FFD4025021	FFD4025022	
125	48	4+4	28	30	54,9°	4		40	4	AS	2	HOMAG	FFD4025023	FFD4025024	
125	65	3+3	30	30	54,9°					AS	1		FFD4025025	FFD4025026	
125	65	4+4	40	30	54,9°					AS	1		FFD4025027	FFD4025028	
125	65	3+3	30	30	54,9°	8		49	8	AS	2	BIESSE	FFD4025029	FFD4025030	
125	65	4+4	40	30	54,9°	8		49	8	AS	2	BIESSE	FFD4025031	FFD4025032	
125	65	3+3	30	30	54,9°	25,4		40,6		AS	7	BRANDT - IMA SCM IDM - BIESSE	FFD4025033	FFD4025034	
125	65	4+4	40	30	54,9°	25,4		40,6		AS	7	BRANDT - IMA SCM IDM - BIESSE	FFD4025035	FFD4025036	
125	65	3+3	30	30	54,9°	12,5		40	12,5	AS	2	HOMAG	FFD4025037	FFD4025038	
125	65	4+4	40	30	54,9°	12,5		40	12,5	AS	2	HOMAG	FFD4025039	FFD4025040	
125	65	3+3	30	30	54,9°	28		25	12	AS	2	GRIGGIO - HOLZ-HER	FFD4025041	FFD4025042	
125	65	4+4	40	30	54,9°	28		25	12	AS	2	GRIGGIO - HOLZ-HER	FFD4025043	FFD4025044	

D150				DIMENSIONI DIMENSIONS		MACCHINA		ARTICOLI ITEMS		PREZZI €					
				Pag. 232		FFD4025 - H4,5 mm									
D	LU	Z	Z TOT	DB	β° AXIAL ANGLE	A	AI	B	C	S/AS	TYPE	MACHINE BRANDS	COD SX / LH	COD DX / RH	PRICES €
150	43	3+3	30	30	54,9°	1,5		40	1,5	AS	2	HOMAG	FFD4025045	FFD4025046	
150	43	4+4	40	30	54,9°	1,5		40	1,5	AS	2	HOMAG	FFD4025047	FFD4025048	
150	65	3+3	30	30	54,9°	13,75		40	13,75	AS	2	HOMAG	FFD4025049	FFD4025050	
150	65	4+4	40	30	54,9°	13,75		40	13,75	AS	2	HOMAG	FFD4025051	FFD4025052	

FRESE CON FORO - QUADRANTE BORDATRICE
CUTTERS WITH BORE - SQUARING EDGBANDING

FFD - FFS

LIGHT FLEX 1 FFD4026

FRESE BORDATRICI AD INSERTI
IN DIAMANTE PCD H3 ASSIALE 35°

JOINTING CUTTER WITH PCD INSERTS
PCD H3 AXIAL 35°

Frese bordatrici per rettifica ad elica in diamante con placchetta H3 mm, angolo assiale di taglio 35°. Possibilità di cambiare l'inserto da positivo a negativo con massima possibilità di composizione.

Jointing cutter with pcd inserts, PCD H3, axial 35°. It's possible to change the inserts position to have symmetrical and asymmetrical cutter.

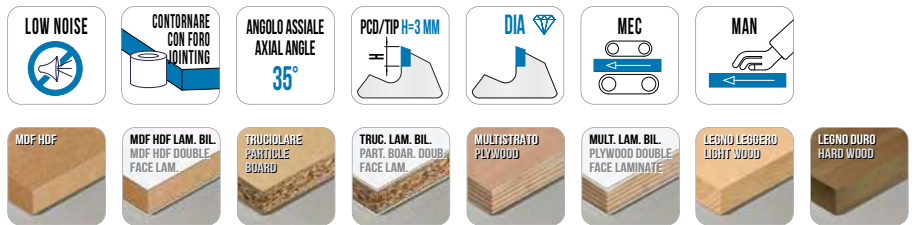

DIMENSIONI DIMENSIONS										MACCHINA		ARTICOLI ITEMS		PREZZI €	
D	LU	Z EFF	Z TOT	DB	β° AXIAL ANGLE	A	AI	B	C	S/AS	TYPE	MACHINE BRANDS	COD SX / LH	COD DX / RH	PRICES €
▼ D80															
80	44	2+2	8	30	35°	3		53	3	AS	3	BIESSE	FFD4026001	FFD4026002	
80	44	3+3	12	30	35°	3		53	3	AS	3	BIESSE	FFD4026003	FFD4026004	
80	44	2+2	8	30	35°	13,5		75	13,5	S	3	BIESSE	FFD4026005	FFD4026005	
80	44	3+3	12	30	35°	13,5		75	13,5	S	3	BIESSE	FFD4026007	FFD4026007	
80	65	2+2	12	25	35°	4,5		63		AS	7	FELDER FORMAT 4	FFD4026055	FFD4026056	
80	65	3+3	18	25	35°	4,5		63		AS	7	FELDER FORMAT 4	FFD4026057	FFD4026058	
80	65	2+2	12	30	35°	8		53	8	S	8	BIESSE	FFD4026059	FFD4026060	
80	65	3+3	18	30	35°	8		53	8	S	8	BIESSE	FFD4026061	FFD4026062	
▼ D100															
100	44	2+2	8	30	35°			52	6	AS	9	SCM - STEFANI	FFD4026009	FFD4026010	
100	44	3+3	12	30	35°			52	6	AS	9	SCM - STEFANI	FFD4026011	FFD4026012	
100	44	2+2	8	30	35°	14		61		AS	6	HEBROCK - EBM	FFD4026013	FFD4026014	
100	44	3+3	12	30	35°	14		61		AS	6	HEBROCK - EBM	FFD4026015	FFD4026016	
100	44	2+2	8	30	35°	11		25	11	AS	2	HOLZ-HER 1891	FFD4026017	FFD4026018	
100	44	3+3	12	30	35°	11		25	11	AS	2	HOLZ-HER 1891	FFD4026019	FFD4026020	
100	44	2+2	8	25	35°	6,5		40,6		AS	7	BRANDT 1110F BRANDT 1120FC	FFD4026021	FFD4026022	
100	44	3+3	12	25	35°	6,5		40,6		AS	7	BRANDT 1110F BRANDT 1120FC	FFD4026023	FFD4026024	
100	44	2+2	8	30	35°	6,5		40,6		AS	7	BRANDT	FFD4026025	FFD4026026	
100	44	3+3	12	30	35°	6,5		40,6		AS	7	BRANDT	FFD4026027	FFD4026028	
100	44	3+3	12	30	35°	14		75	14	S	3	BIESSE	FFD4026029	FFD4026029	
100	54	2+2	10	30	35°	3		60		AS	7	SCM - STEFANI	FFD4026031	FFD4026032	
100	54	3+3	15	30	35°	3		60		AS	7	SCM - STEFANI	FFD4026033	FFD4026034	
100	65	3+3	18	30	35°	3,5		75	3,5	S	3	BIESSE AKRON 600 BIESSE AKRON 800	FFD4026035	FFD4026035	
100	65	3+3	18	30	35°	28,4		40,6		AS	7	BRANDT - SCM	FFD4026037	FFD4026038	
100	65	2+2	12	30	35°	11,5		56,5		AS	7	FRAVOL	FFD4026039	FFD4026040	
100	65	3+3	18	30	35°	11,5		56,5		AS	7	FRAVOL	FFD4026041	FFD4026042	
100	65	3+3	18	30	35°	28,5		39,5		AS	7	HOLZHER 1804	FFD4026043	FFD4026044	
100	65	2+2	12	30	35°	31		25	12	AS	2	HOLZHER 1891	FFD4026045	FFD4026046	
100	65	2+2	12	30	35°	18		58	5,5	AS	8	SCM - STEFANI	FFD4026047	FFD4026048	
100	65	3+3	18	30	35°	18		58	5,5	AS	8	SCM - STEFANI	FFD4026049	FFD4026050	
▼ D125															
125	44	3+3	12	30	35°	3,5		40	3,5	S	2	BIESSE - HOMAG	FFD4026051	FFD4026051	
125	65	3+3	18	30	35°	14		40	14	S	2	BIESSE - HOMAG	FFD4026053	FFD4026053	

RICAMBI PARTS										
COLTELLINO INSERTS		β° AXIAL ANGLE	LU USEFUL LENGTH	H HEIGHT	D DIAMETER	ARTICOLI ITEMS	PREZZO PRICE	VITE INSERT SCREW	ARTICOLO ITEM	PREZZO PRICE
		35°	15	14	80	RIC9001012			RIC9007127	
		35°	15	14	100	RIC9001011				
		35°	15	14	125	RIC9001013				

LIGHT FLEX 2 FFD4027

FRESE BORDATRICI AD INSERTI
IN DIAMANTE PCD H3 ASSIALE 45°

JOINTING CUTTER WITH PCD INSERTS
PCD H3 AXIAL 45°

Frese bordatrici per rettifica ad elica in diamante con placchetta H3 mm, angolo assiale di taglio 45°. Possibilità di cambiare l'inserto da positivo a negativo con massima possibilità di composizione.

Jointing cutter with pcd inserts, PCD H3, axial 45°. It's possible to change the inserts position to have symmetrical and asymmetrical cutter.

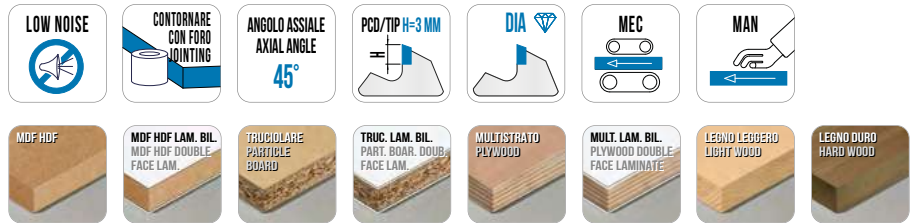
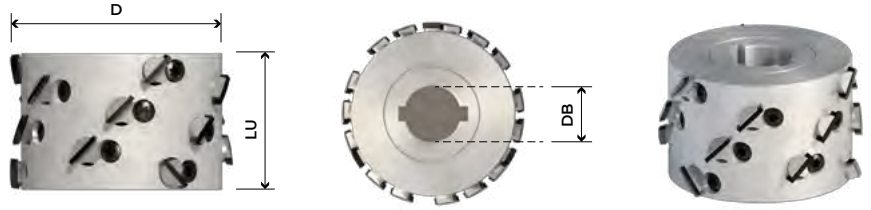

DIMENSIONI		DIMENSIONS		MACCHINA		ARTICOLI		ITEMS		PREZZI €				
D	LU	Z	Z	β°	A	AI	B	C	S/AS	TYPE	MACHINE BRANDS	COD SX / LH	COD DX / RH	PRICES €
		EFF	TOT	AXIAL ANGLE										
▼ D80														
80	47	2+2	10	30	45°	1	53	1	AS	3	BIESSE	FFD4027001	FFD4027002	
80	47	3+3	15	30	45°	1	53	1	AS	3	BIESSE	FFD4027003	FFD4027004	
80	47	2+2	10	30	45°	11,5	75	11,5	S	3	BIESSE	FFD4027005	FFD4027005	
80	47	3+3	15	30	45°	11,5	75	11,5	S	3	BIESSE	FFD4027007	FFD4027007	
80	65	2+2	14	25	45°	4,5	63		AS	7	FELDER FORMAT 4	FFD4027055	FFD4027056	
80	65	3+3	21	25	45°	4,5	63		AS	7	FELDER FORMAT 4	FFD4027057	FFD4027058	
80	65	2+2	14	30	45°	8,5	53	8,5	S	2	BIESSE	FFD4027059	FFD4027060	
80	65	3+3	21	30	45°	8,5	53	8,5	S	2	BIESSE	FFD4027061	FFD4027062	
▼ D100														
100	47	2+2	10	30	45°		52		AS	1		FFD4027009	FFD4027010	
100	47	3+3	15	30	45°		52		AS	1		FFD4027011	FFD4027012	
100	47	2+2	10	30	45°	9	61		AS	6	HEBROCK - EBM	FFD4027013	FFD4027014	
100	47	3+3	15	30	45°	9	61		AS	6	HEBROCK - EBM	FFD4027015	FFD4027016	
100	47	2+2	10	30	45°	13,5	25	13,5	AS	2	HOLZ-HER 1891	FFD4027017	FFD4027018	
100	47	3+3	15	30	45°	13,5	25	13,5	AS	2	HOLZ-HER 1891	FFD4027019	FFD4027020	
100	47	2+2	10	25	45°	11,4	40,6		AS	7	BRANDT 1110F BRANDT 1120FC	FFD4027021	FFD4027022	
100	47	3+3	15	25	45°	11,4	40,6		AS	7	BRANDT 1110F BRANDT 1120FC	FFD4027023	FFD4027024	
100	47	2+2	10	30	45°	11,4	40,6		AS	7	BRANDT	FFD4027025	FFD4027026	
100	47	3+3	15	30	45°	11,4	40,6		AS	7	BRANDT	FFD4027027	FFD4027028	
100	47	3+3	15	30	45°	11,5	75	11,5	S	3	BIESSE	FFD4027029	FFD4027029	
100	56	2+2	12	30	45°	8	60		AS	8	SCM - STEFANI	FFD4027031	FFD4027032	
100	56	3+3	18	30	45°	8	60		AS	8	SCM - STEFANI	FFD4027033	FFD4027034	
100	65	3+3	21	30	45°	2,5	75	2,5	S	3	BIESSE AKRON 600 BIESSE AKRON 800	FFD4027035	FFD4027035	
100	65	3+3	21	30	45°	29,4	40,6		AS	7	BRANDT - SCM	FFD4027037	FFD4027038	
100	65	2+2	14	30	45°	13,5	56,5		AS	7	FRAVOL	FFD4027039	FFD4027040	
100	65	3+3	21	30	45°	13,5	56,5		AS	7	FRAVOL	FFD4027041	FFD4027042	
100	65	3+3	21	30	45°	30,5	39,5		AS	7	HOLZHER 1804	FFD4027043	FFD4027044	
100	65	2+2	14	30	45°	33	25	12	AS	2	HOLZHER 1891	FFD4027045	FFD4027046	
100	65	2+2	14	30	45°	18	58	5,5	AS	8	SCM - STEFANI	FFD4027047	FFD4027048	
100	65	3+3	21	30	45°	18	58	5,5	AS	8	SCM - STEFANI	FFD4027049	FFD4027050	
▼ D125														
125	47	3+3	15	30	45°	6	40	6	S	2	BIESSE - HOMAG	FFD4027051	FFD4027051	
125	65	3+3	21	30	45°	15	40	15	S	2	BIESSE - HOMAG	FFD4027053	FFD4027053	

RICAMBI PARTS										
COLTELLINO INSERTS		β° AXIAL ANGLE	LU USEFUL LENGTH	H HEIGHT	D DIAMETER	ARTICOLI ITEMS	PREZZO PRICE	VITE INSERT SCREW	ARTICOLO ITEM	PREZZO PRICE
		45°	15	14	80	RIC9001010			RIC9007127	
		45°	15	14	100	RIC9001002		VITI M7 TORX T30		
		45°	15	14	125	RIC9001003				

LIGHT FLEX 3 FFD4028

FRESE BORDATRICI AD INSERTI
IN DIAMANTE PCD H3 MM
ASSIALE 54.9°

JOINTING CUTTER WITH PCD INSERTS
PCD H3 MM AXIAL 54.9°

Frese bordatrici per rettifica ad elica in diamante con placchetta H3 mm, angolo assiale di taglio 54.9°. Possibilità di cambiare l'inserto da positivo a negativo.

Jointing cutter with pcd inserts, PCD H3 mm, axial 54.9°. It's possible to change the inserts position to have symmetrical and asymmetrical cutter.

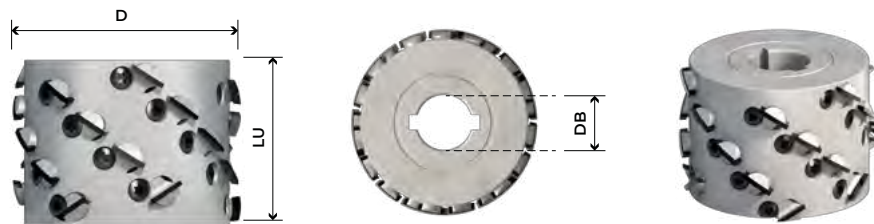

DIMENSIONI DIMENSIONS										MACCHINA			ARTICOLI ITEMS		PREZZI €
D	LU	Z EFF	Z TOT	DB	β° AXIAL ANGLE	A	AI	B	C	S/AS	TYPE	MACHINE BRANDS	COD SX / LH	COD DX / RH	PRICES €
Pag. 232															
▼ D80															
80	44	2+2	12	30	54,9°	1		53	1	AS	3	BIESSE	FFD4028001	FFD4028002	
80	44	3+3	18	30	54,9°	1		53	1	AS	3	BIESSE	FFD4028003	FFD4028004	
80	44	2+2	12	30	54,9°	14		75	14	S	3	BIESSE	FFD4028005	FFD4028005	
80	44	3+3	18	30	54,9°	14		75	14	S	3	BIESSE	FFD4028007	FFD4028007	
80	65	2+2	18	25	54,9°	4,5		63		AS	7	FELDER FORMAT 4	FFD4028055	FFD4028056	
80	65	3+3	27	25	54,9°	4,5		63		AS	7	FELDER FORMAT 4	FFD4028057	FFD4028058	
80	65	2+2	14	30	54,9°	8,5		53	8,5	S	2	BIESSE	FFD4028059	FFD4028060	
80	65	3+3	21	30	54,9°	8,5		53	8,5	S	2	BIESSE	FFD4028061	FFD4028062	
▼ D100															
100	44	2+2	12	30	54,9°			52		AS	1		FFD4028009	FFD4028010	
100	44	3+3	18	30	54,9°			52		AS	1		FFD4028011	FFD4028012	
100	44	2+2	12	30	54,9°	10		61		AS	6	HEBROCK - EBM	FFD4028013	FFD4028014	
100	44	3+3	18	30	54,9°	10		61		AS	6	HEBROCK - EBM	FFD4028015	FFD4028016	
100	44	2+2	12	30	54,9°	13		25	13	AS	2	HOLZ-HER 1891	FFD4028017	FFD4028018	
100	44	3+3	18	30	54,9°	13		25	13	AS	2	HOLZ-HER 1891	FFD4028019	FFD4028020	
100	44	2+2	12	25	54,9°	10,4		40,6		AS	7	BRANDT 1110F BRANDT 1120FC	FFD4028021	FFD4028022	
100	44	3+3	18	25	54,9°	10,4		40,6		AS	7	BRANDT 1110F BRANDT 1120FC	FFD4028023	FFD4028024	
100	44	2+2	12	30	54,9°	10,4		40,6		AS	7	BRANDT	FFD4028025	FFD4028026	
100	44	3+3	18	30	54,9°	10,4		40,6		AS	7	BRANDT	FFD4028027	FFD4028028	
100	44	3+3	18	30	54,9°	12		75	12	S	3	BIESSE	FFD4028029	FFD4028029	
100	51	2+2	14	30	54,9°	2		60		AS	8	SCM - STEFANI	FFD4028031	FFD4028032	
100	51	3+3	21	30	54,9°	2		60		AS	8	SCM - STEFANI	FFD4028033	FFD4028034	
100	65	3+3	27	30	54,9°	1,5		75	1,5	S	3	BIESSE AKRON 600 BIESSE AKRON 800	FFD4028035	FFD4028035	
100	65	3+3	27	30	54,9°	31,4		40,6		AS	7	BRANDT - SCM	FFD4028037	FFD4028038	
100	65	2+2	18	30	54,9°	15,5		56,5		AS	7	FRAVOL	FFD4028039	FFD4028040	
100	65	3+3	27	30	54,9°	15,5		56,5		AS	7	FRAVOL	FFD4028041	FFD4028042	
100	65	3+3	27	30	54,9°	32,5		39,5		AS	7	HOLZHER 1804	FFD4028043	FFD4028044	
100	65	2+2	18	30	54,9°	35		25	12	AS	2	HOLZHER 1891	FFD4028045	FFD4028046	
100	65	2+2	18	30	54,9°	18		58	5,5	AS	8	SCM - STEFANI	FFD4028047	FFD4028048	
100	65	3+3	27	30	54,9°	18		58	5,5	AS	8	SCM - STEFANI	FFD4028049	FFD4028050	
▼ D125															
125	44	3+3	18	30	54,9°	5,5		40	5,5	S	2	BIESSE - HOMAG	FFD4028051	FFD4028051	
125	65	3+3	27	30	54,9°	16		40	16	S	2	BIESSE - HOMAG	FFD4028053	FFD4028053	

RICAMBI PARTS										
COLTELLINO INSERTS		β° AXIAL ANGLE	LU USEFUL LENGTH	H HEIGHT	D DIAMETER	ARTICOLI ITEMS	PREZZO PRICE	VITE INSERT SCREW	ARTICOLO ITEM	PREZZO PRICE
		54,9°	15	14	80	RIC9001005				
		54,9°	15	14	100	RIC9001006			RIC9007127	
		54,9°	15	14	125	RIC9001007		VITI M7 TORX T30		

AIRCUT 2 FFD4041

FRESE BORDATRICI AD
INSERTI IN DIAMANTE PCD
H2,5 MM, ASSIALE 30°

JOINTING CUTTER WITH PCD
INSERTS PCD H2,5 MM
AXIAL 30°

Frese bordatrici per rettifica
ad elica in diamante con
placchetta H2,5 mm, angolo
assiale 30°.

Jointing cutter with pcd inserts,
PCD H2,5 mm, axial 30°.

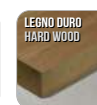
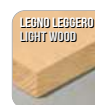
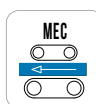
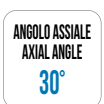
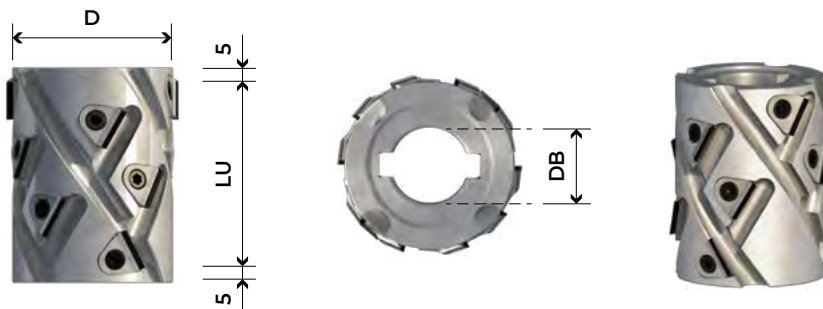

DIMENSIONI		DIMENSIONS		MACCHINA		ARTICOLI		ITEMS		PREZZI €					
D	LU	Z EFF	Z TOT	DB	β° AXIAL ANGLE	A	AI	B	C	S/AS	TYPE	MACHINE BRANDS	COD SX / LH	COD DX / RH	PRICES €
▼ D60															
60	34	2+2	6	20	30°			43,5		AS	1	CEHISA	FFD4041001	FFD4041002	
60	34	3+3	9	20	30°			43,5		AS	1	CEHISA	FFD4041003	FFD4041004	
60	44	2+2	8	25	30°			54		AS	1	FRAVOL - FELDER	FFD4041005	FFD4041006	
60	44	3+3	12	25	30°			54		AS	1	FRAVOL - FELDER	FFD4041007	FFD4041008	
60	55	2+2	10	20	30°			65		AS	1		FFD4041009	FFD4041010	
60	55	3+3	15	20	30°			65		AS	1		FFD4041011	FFD4041012	
60	55	2+2	10	25	30°			65		AS	1		FFD4041013	FFD4041014	
60	55	3+3	15	25	30°			65		AS	1		FFD4041015	FFD4041016	
60	55	2+2	10	16	30°	17	31	17		S	2		FFD4041017	FFD4041018	
60	55	3+3	15	16	30°	17	31	17		S	2		FFD4041019	FFD4041020	
60	55	2+2	10	20	30°	17	43,5	5		AS	2	CEHISA	FFD4041021	FFD4041022	
60	55	3+3	15	20	30°	17	43,5	5		AS	2	CEHISA	FFD4041023	FFD4041024	
60	55	2+2	10	25	30°	8,5	48	8,5		AS	2	CASADEI	FFD4041025	FFD4041026	
60	55	3+3	15	25	30°	8,5	48	8,5		AS	2	CASADEI	FFD4041027	FFD4041028	
60	65	2+2	12	20	30°			75		AS	1		FFD4041029	FFD4041030	
60	65	3+3	18	20	30°			75		AS	1		FFD4041031	FFD4041032	
60	65	2+2	12	25	30°			75		AS	1	FELDER FORMAT 4 FRAVOL	FFD4041033	FFD4041034	
60	65	3+3	18	25	30°			75		AS	1	FELDER FORMAT 4 FRAVOL	FFD4041035	FFD4041036	
60	65	2+2	12	25	30°	13			5	AS	2	FRAVOL	FFD4041037	FFD4041038	
60	65	3+3	18	25	30°	13			5	AS	2	FRAVOL	FFD4041039	FFD4041040	
▼ D70															
70	44	2+2	8	30	30°	6		60		AS	6		FFD4041041	FFD4041042	
70	44	3+3	12	30	30°	6		60		AS	6		FFD4041043	FFD4041044	
70	44	2+2	8	30	30°	14	9	24	11	AS	10	HOLZ-HER	FFD4041045	FFD4041046	
70	44	3+3	12	30	30°	14	9	24	11	AS	10	HOLZ-HER	FFD4041047	FFD4041048	
70	44	2+2	8	30	30°	13				AS	7		FFD4041049	FFD4041050	
70	44	3+3	12	30	30°	13				AS	7		FFD4041051	FFD4041052	
70	44	2+2	8	25	30°					AS	1	HEBROCK	FFD4041053	FFD4041054	
70	44	3+3	12	25	30°					AS	1	HEBROCK	FFD4041055	FFD4041056	
70	55	2+2	10	30	30°	14,5	9	30,5	11	AS	10	HOLZ-HER Aggregate 1801	FFD4041057	FFD4041058	
70	55	3+3	15	30	30°	14,5	9	30,5	11	AS	10	HOLZ-HER Aggregate 1801	FFD4041059	FFD4041060	
70	65	2+2	12	30	30°	14,5	9	40,5	11	AS	10	HOLZ-HER Arcus 1801	FFD4041061	FFD4041062	
70	65	3+3	18	30	30°	14,5	9	40,5	11	AS	10	HOLZ-HER Arcus 1801	FFD4041063	FFD4041064	

DIMENSIONI		DIMENSIONS		MACCHINA		ARTICOLI		ITEMS		PREZZI €					
D	LU	Z EFF	Z TOT	DB	β° AXIAL ANGLE	A	AI	B	C	S/AS	TYPE	MACHINE BRANDS	COD SX / LH	COD DX / RH	PRICES €
▼ D80															
80	44	2+2	8	30	30°			53		AS	1	BIESSE	FFD4041065	FFD4041066	
80	44	3+3	12	30	30°			53		AS	1	BIESSE	FFD4041067	FFD4041068	
80	44	2+2	8	30	30°	10,5		75	10,5	S	3	BIESSE	FFD4041069	FFD4041070	
80	44	3+3	12	30	30°	10,5		75	10,5	S	3	BIESSE	FFD4041071	FFD4041072	
80	65	2+2	12	25	30°	6		63	6	AS	2	FELDER FORMAT 4	FFD4041073	FFD4041074	
80	65	3+3	18	25	30°	6		63	6	AS	2	FELDER FORMAT 4	FFD4041075	FFD4041076	
80	65	2+2	12	25	30°	11		53	11	S	2	BIESSE	FFD4041123	FFD4041124	
80	65	3+3	18	25	30°	11		53	11	S	2	BIESSE	FFD4041125	FFD4041126	
▼ D100															
100	44	2+2	8	30	30°			52		AS	1	SCM - STEFANI	FFD4041077	FFD4041078	
100	44	3+3	12	30	30°			52		AS	1	SCM - STEFANI	FFD4041079	FFD4041080	
100	44	2+2	8	30	30°	7		61		AS	6	HEBROCK - EBM	FFD4041081	FFD4041082	
100	44	3+3	12	30	30°	7		61		AS	6	HEBROCK - EBM	FFD4041083	FFD4041084	
100	44	2+2	8	30	30°	14,5		25	14,5	AS	2	HOLZ-HER 1891	FFD4041085	FFD4041086	
100	44	3+3	12	30	30°	14,5		25	14,5	AS	2	HOLZ-HER 1891	FFD4041087	FFD4041088	
100	44	2+2	8	25	30°	13,4		40,6		AS	7	BRANDT 1110F BRANDT 1120FC	FFD4041089	FFD4041090	
100	44	3+3	12	25	30°	13,4		40,6		AS	7	BRANDT 1110F BRANDT 1120FC	FFD4041091	FFD4041092	
100	44	2+2	8	30	30°	13,4		40,6		AS	7	BRANDT	FFD4041093	FFD4041094	
100	44	3+3	12	30	30°	13,4		40,6		AS	7	BRANDT	FFD4041095	FFD4041096	
100	44	3+3	12	30	30°	10,5		75	10,5	S	3	BIESSE	FFD4041097	FFD4041098	
100	55	2+2	10	30	30°					AS	1	SCM - STEFANI	FFD4041099	FFD4041100	
100	55	3+3	15	30	30°					AS	1	SCM - STEFANI	FFD4041101	FFD4041102	
100	55	2+2	10	30	30°	25,1		40,6		AS	7	BRANDT - HOMAG	FFD4041127	FFD4041128	
100	55	3+3	15	30	30°	25,1		40,6		AS	7	BRANDT - HOMAG	FFD4041129	FFD4041130	
100	65	3+3	18	30	30°			75		S	1	BIESSE AKRON 600 BIESSE AKRON 800	FFD4041103	FFD4041104	
100	65	3+3	18	30	30°	34,4		40,6		AS	7	BRANDT - SCM	FFD4041105	FFD4041106	
100	65	2+2	12	30	30°	18,5		56,5		AS	7	FRAVOL	FFD4041107	FFD4041108	
100	65	3+3	18	30	30°	18,5		56,5		AS	7	FRAVOL	FFD4041109	FFD4041110	
100	65	3+3	18	30	30°	35,5		39,5		AS	7	HOLZHER 1804	FFD4041111	FFD4041112	
100	65	2+2	12	30	30°	34,5		25	15,5	AS	2	HOLZHER 1891	FFD4041113	FFD4041114	
100	65	2+2	12	30	30°	17		58	5,5	AS	8	SCM - STEFANI	FFD4041115	FFD4041116	
100	65	3+3	18	30	30°	17		58	5,5	AS	8	SCM - STEFANI	FFD4041117	FFD4041118	
▼ D125															
125	44	3+3	12	30	30°	7		40	7	S	2	BIESSE - HOMAG	FFD4041119	FFD4041120	
125	65	3+3	18	30	30°	17,5		40	17,5	S	2	BIESSE - HOMAG	FFD4041121	FFD4041122	

RICAMBI PARTS												
COLTELLINO INSERTS		β° AXIAL ANGLE	LU USEFUL LENGTH	LT TOT. LENGTH	D DIAM.	B THICK.	ROT ROTATION	ARTICOLI ITEMS	PREZZO PRICE	VITE INSERT SCREW	ARTICOLO ITEM	PREZZO PRICE
		30°	15	14	60	5	DX/SX	RIC9012001			RIC9007056	
		30°	15	14	70	5	DX/SX	RIC9012024				
		30°	15	14	80	5	DX/SX	RIC9012002				
		30°	15	14	100	5	DX/SX	RIC9012003				
		30°	15	14	125	5	DX/SX	RIC9012004				
										M5X6X1,5(T20)		

AIRCUT 3 FFD4042

FRESE BORDATRICI AD
INSERTI IN DIAMANTE PCD
H2,5 MM ASSIALE 45°

JOINTING CUTTER WITH PCD
INSERTS PCD H2,5 MM
AXIAL 45°

Frese bordatrici per rettifica
ad elica in diamante con
placchetta H2,5 mm, angolo
assiale 45°.

Jointing cutter with pcd inserts,
PCD H2,5 mm, axial 45°.

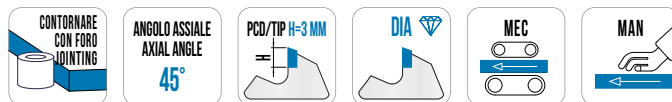

DIMENSIONI		DIMENSIONS		MACCHINA		ARTICOLI		ITEMS		PREZZI €				
D	LU	Z EFF	Z TOT	β° AXIAL ANGLE	A	AI	B	C	S/AS	TYPE	MACHINE BRANDS	COD SX / LH	COD DX / RH	PRICES €
▼ D100														
100	46	2+2	10	30	45°	5	52	5	AS	2	SCM - STEFANI	FFD4042001	FFD4042002	
100	46	3+3	15	30	45°	5	52	5	AS	2	SCM - STEFANI	FFD4042003	FFD4042004	
100	46	2+2	10	30	45°		61		AS	1	HEBROCK - EBM	FFD4042005	FFD4042006	
100	46	3+3	15	30	45°		61		AS	1	HEBROCK - EBM	FFD4042007	FFD4042008	
100	46	2+2	10	30	45°	18,5	25	18,5	AS	2	HOLZ-HER 1891	FFD4042009	FFD4042010	
100	46	3+3	15	30	45°	18,5	25	18,5	AS	2	HOLZ-HER 1891	FFD4042011	FFD4042012	
100	46	2+2	10	25	45°	21,4	40,6		AS	7	BRANDT 1110F BRANDT 1120FC	FFD4042013	FFD4042014	
100	46	3+3	15	25	45°	21,4	40,6		AS	7	BRANDT 1110F BRANDT 1120FC	FFD4042015	FFD4042016	
100	46	2+2	10	30	45°	21,4	40,6		AS	7	BRANDT	FFD4042017	FFD4042018	
100	46	3+3	15	30	45°	21,4	40,6		AS	7	BRANDT	FFD4042019	FFD4042020	
100	46	3+3	15	30	45°	6,5	75	6,5	S	3	BIESSE	FFD4042021	FFD4042022	
100	54,5	2+2	12	30	45°				AS	1	SCM - STEFANI	FFD4042023	FFD4042024	
100	54,5	3+3	18	30	45°				AS	1	SCM - STEFANI	FFD4042025	FFD4042026	
100	54,5	2+2	12	30	45°	30,9	40,6		AS	7	HOMAG - BRANDT	FFD4042047	FFD4042048	
100	54,5	3+3	18	30	45°	30,9	40,6		AS	7	HOMAG - BRANDT	FFD4042049	FFD4042050	
100	63,5	3+3	21	30	45°	2,25	75	2,25	S	2	BIESSE AKRON 600 BIESSE AKRON 800	FFD4042027	FFD4042028	
100	63,5	3+3	21	30	45°	38,9	40,6		AS	7	BRANDT - SCM	FFD4042029	FFD4042030	
100	63,5	2+2	14	30	45°	23	56,5		AS	7	FRAVOL	FFD4042031	FFD4042032	
100	63,5	3+3	21	30	45°	23	56,5		AS	7	FRAVOL	FFD4042033	FFD4042034	
100	63,5	3+3	21	30	45°	40	39,5		AS	7	HOLZHER 1804	FFD4042035	FFD4042036	
100	63,5	2+2	14	30	45°	37,5	25	17	AS	2	HOLZHER 1891	FFD4042037	FFD4042038	
100	63,5	2+2	14	30	45°	21,5	58	5,5	AS	8	SCM - STEFANI	FFD4042039	FFD4042040	
100	63,5	3+3	21	30	45°	21,5	58	5,5	AS	8	SCM - STEFANI	FFD4042041	FFD4042042	
▼ D125														
125	46	3+3	15	30	45°	11	40	11	S	2	BIESSE - HOMAG	FFD4042043	FFD4042044	
125	63,5	3+3	21	30	45°	19,75	40	19,75	S	2	BIESSE - HOMAG	FFD4042045	FFD4042046	

RICAMBI PARTS												
COLTELLINO INSERTS		β° AXIAL ANGLE	LU USEFUL LENGTH	LT TOT. LENGTH	D DIAM.	B THICN.	ROT ROTATION	ARTICOLI ITEMS	PREZZO PRICE	VITE INSERT SCREW	ARTICOLO ITEM	PREZZO PRICE
		45°	15	14	100	5	DX/SX	RIC9012007			RIC9007056	
		45°	15	14	125	5	DX/SX	RIC9012008				

DIAFIX 1 FFD4043

INSERTO REGOLABILE RADIALMENTE DIAMETRO COSTANTE
RADIUS ADJUSTABLE INSERT FIXED DIAMETER

NEW

FRESE BORDATRICI AD
INSERTI IN DIAMANTE
PCD H5,5 ASSIALE 30°
CON INSERTI REGOLABILI
ASSIALMENTE E DIAMETRO
COSTANTE POST AFFILATURA

PCD INSERTS JOINTING
CUTTER WITH CONSTANT
DIAMETER

Bordatrici da rettifica in PCD
con placchetta H5,5mm, angolo
assiale di taglio 30°. I particolari
inserti regolabili assialmente
permettono di mantenere
sempre il diametro originale
dopo la riaffilatura della fresa.

PCD insert jointing cutter PCD
H5,5 axial cut 30°. The insert are
adjustable to keep a constant
diameter after grinding.

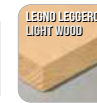
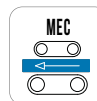
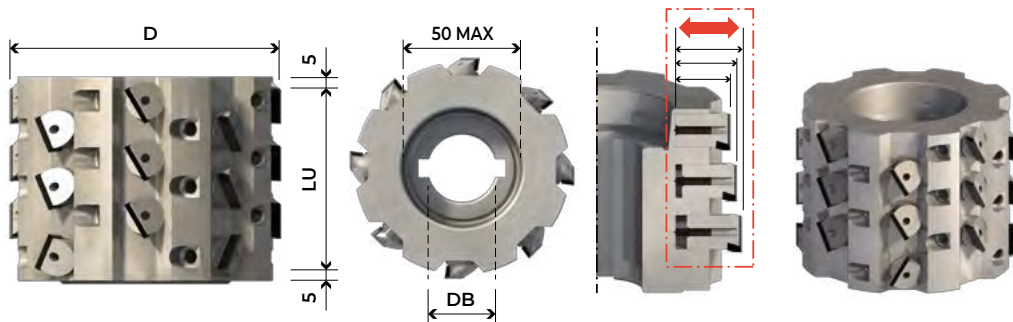

DIMENSIONI DIMENSIONS

MACCHINA MACHINE

ARTICOLI ITEMS

PREZZI € PRICES €

Pag. 232												MACHINE BRANDS		COD SX / LH		COD DX / RH		PRICES €
D	LU	Z EFF	Z TOT	DB	DKN	β° AXIAL ANGLE	A	AI	B	C	S/AS	TYPE					PRICES €	
▼ D100																		
100	44	2+2	8	30	2	30°			52		AS	1	SCM - STEFANI	FFD4043001	FFD4043002			
100	44	3+3	12	30	2	30°			52		AS	1	SCM - STEFANI	FFD4043003	FFD4043004			
100	44	2+2	8	30	2	30°	7		61		AS	6	HEBROCK - EBM	FFD4043005	FFD4043006			
100	44	3+3	12	30	2	30°	7		61		AS	6	HEBROCK - EBM	FFD4043007	FFD4043008			
100	44	2+2	8	30	2	30°	14,5		25	14,5	AS	2	HOLZ-HER 1891	FFD4043009	FFD4043010			
100	44	3+3	12	30	2	30°	14,5		25	14,5	AS	2	HOLZ-HER 1891	FFD4043011	FFD4043012			
100	44	2+2	8	25	2	30°	13,4		40,6		AS	7	BRANDT 1110F - BRANDT 1120FC	FFD4043013	FFD4043014			
100	44	3+3	12	25	2	30°	13,4		40,6		AS	7	BRANDT 1110F - BRANDT 1120FC	FFD4043015	FFD4043016			
100	44	2+2	8	30	2	30°	13,4		40,6		AS	7	BRANDT	FFD4043017	FFD4043018			
100	44	3+3	12	30	2	30°	13,4		40,6		AS	7	BRANDT	FFD4043019	FFD4043020			
100	44	3+3	12	30	2	30°	10,5		75	10,5	S	3	BIESSE	FFD4043021	FFD4043022			
100	55	2+2	10	30	2	30°					AS	1	SCM - STEFANI	FFD4043023	FFD4043024			
100	55	3+3	15	30	2	30°					AS	1	SCM - STEFANI	FFD4043025	FFD4043026			
100	55	2+2	10	30	2	30°	25,1		40,6		AS	7	BRANDT - HOMAG	FFD4043027	FFD4043028			
100	55	3+3	15	30	2	30°	25,1		40,6		AS	7	BRANDT - HOMAG	FFD4043029	FFD4043030			
100	65	3+3	18	30	2	30°			75		S	1	BIESSE AKRON 600 - BIESSE AKRON 800	FFD4043031	FFD4043032			
100	65	3+3	18	30	2	30°	34,4		40,6		AS	7	BRANDT - SCM	FFD4043033	FFD4043034			
100	65	2+2	12	30	2	30°	18,5		56,5		AS	7	FRAVOL	FFD4043035	FFD4043036			
100	65	3+3	18	30	2	30°	18,5		56,5		AS	7	FRAVOL	FFD4043037	FFD4043038			
100	65	3+3	18	30	2	30°	35,5		39,5		AS	7	HOLZHER 1804	FFD4043039	FFD4043040			
100	65	2+2	12	30	2	30°	34,5		25	15,5	AS	2	HOLZHER 1891	FFD4043041	FFD4043042			
100	65	2+2	12	30	2	30°	17		58	5,5	AS	8	SCM - STEFANI	FFD4043043	FFD4043044			
100	65	3+3	18	30	2	30°	17		58	5,5	AS	8	SCM - STEFANI	FFD4043045	FFD4043046			
▼ D125																		
125	44	3+3	12	30	2	30°	7		40	7	S	2	BIESSE - HOMAG	FFD4043047	FFD4043048			
125	65	3+3	18	30	2	30°	17,5		40	17,5	S	2	BIESSE - HOMAG	FFD4043049	FFD4043050			

RICAMBI PARTS								
COLTELLINO INSERTS	β° AXIAL ANGLE	LU USEFUL LENGTH	LT TOT. LENGTH	D DIAM.	B THICN.	ROT ROTATION	ARTICOLI ITEMS	PREZZO PRICE
	30°	14	21	100	14	DX	RIC9045001	
	30°	14	21	100	14	SX	RIC9045002	
	30°	14	21	125	14	DX	RIC9045003	
	30°	14	21	125	14	SX	RIC9045004	

RICAMBI PARTS		
GRANI INSERT SCREW	ARTICOLO ITEM	PREZZO PRICE
M4X12	RIC9007120	
M6X8X12	RIC9007014	

TRS 1 FFD4030

FRESE RETTIFICA
REGOLABILI ASSIALITA' 30°

DIA ADJUSTABLE JOINTING
CUTTER CUTTING ANGLE 30°

Fresa in diamante riaffilabile per rettificare, composta da due elementi regolabili tramite spessori, adatta per lavorazioni di pannelli truciolari, nobilitati, rivestiti, laminati, impiallacciati, M.D.F., utilizzabile su macchine squadratrici.

Re-sharpening and adjustable jointing cutter in diamond, made in two pieces adjustable by spacer rings, used on squaring machines.

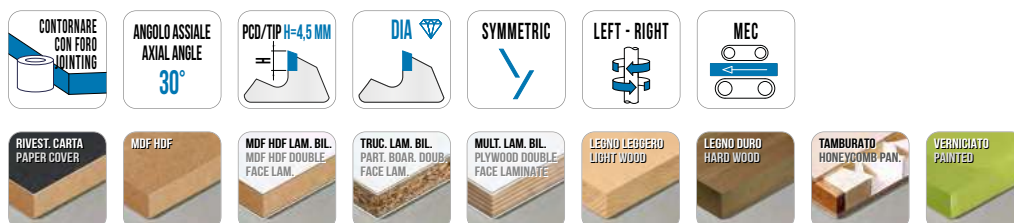
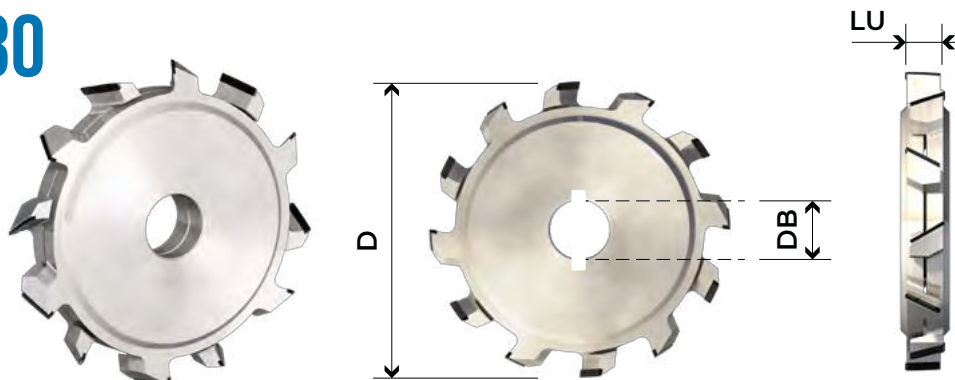

DIMENSIONI DIMENSIONS							ARTICOLI ITEMS		PREZZI €	
D	LU	Z EFF	Z TOT	DB	DKN	β°	H PCD	N. MAX	CODICE	PRICE €
DIAMETER	USEFUL LENGTH	ACTUAL TEETH	TOT. TEETH	HOLE DIAM.		AXIAL ANGLE	PCD HEIGHT	MAX R.P.M.	SKU	
80	25/38	3+3	12	30	2	30°	4,5	16.000	FFD4030001	
80	30/48	3+3	18	30	2	30°	4,5	16.000	FFD4030002	
100	25/38	3+3	12	30	2	30°	4,5	14.000	FFD4030003	
100	30/48	3+3	18	30	2	30°	4,5	14.000	FFD4030004	
125	25/38	3+3	12	30	2	30°	4,5	12.000	FFD4030005	
125	30/48	3+3	18	30	2	30°	4,5	12.000	FFD4030006	
180	25/38	5+5	20	35	2	30°	4,5	10.000	FFD4030007	
180	25/38	5+5	20	40	2	30°	4,5	10.000	FFD4030008	
180	25/38	6+6	24	35	2	30°	4,5	10.000	FFD4030009	
180	25/38	6+6	24	40	2	30°	4,5	10.000	FFD4030010	
180	30/48	5+5	30	35	2	30°	4,5	10.000	FFD4030011	
180	30/48	5+5	30	40	2	30°	4,5	10.000	FFD4030012	
180	30/48	6+6	36	35	2	30°	4,5	10.000	FFD4030013	
180	30/48	6+6	36	40	2	30°	4,5	10.000	FFD4030014	
200	25/38	5+5	20	35	2	30°	4,5	9.000	FFD4030015	
200	25/38	5+5	20	40	2	30°	4,5	9.000	FFD4030016	
200	25/38	6+6	24	35	2	30°	4,5	9.000	FFD4030017	
200	25/38	6+6	24	40	2	30°	4,5	9.000	FFD4030018	
200	25/38	8+8	32	35	2	30°	4,5	9.000	FFD4030019	
200	25/38	8+8	32	40	2	30°	4,5	9.000	FFD4030020	
200	30/48	5+5	30	35	2	30°	4,5	9.000	FFD4030021	
200	30/48	5+5	30	40	2	30°	4,5	9.000	FFD4030022	
200	30/48	6+6	36	35	2	30°	4,5	9.000	FFD4030023	
200	30/48	6+6	36	40	2	30°	4,5	9.000	FFD4030024	
200	30/48	8+8	48	35	2	30°	4,5	9.000	FFD4030025	
200	30/48	8+8	48	40	2	30°	4,5	9.000	FFD4030026	

FRESE CON FORO - SQUADRATRICE BORDATRICE
CUTTERS WITH BORE - SQUARING EDGBANDING

FFD - FFS

TRS 2 FFD4031

FRESE RETTIFICA REGOLABILI
ASSIALITA' 45°

DIA ADJUSTABLE JOINTING
CUTTER CUTTING ANGLE 45°

Fresa in diamante riaffilabile per rettificare, composta da due elementi regolabili tramite spessori, adatta per lavorazioni di pannelli truciolari, nobilitati, rivestiti, laminati, impiallacciati, M.D.F., utilizzabile su macchine squadratrici.

Re-sharpening and adjustable jointing cutter in diamond, made in two pieces adjustable by spacer rings, used on squaring machines.

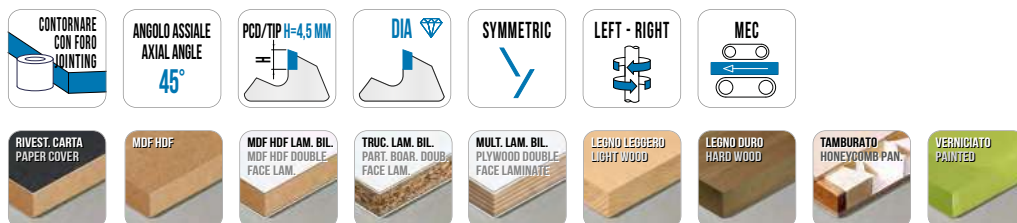
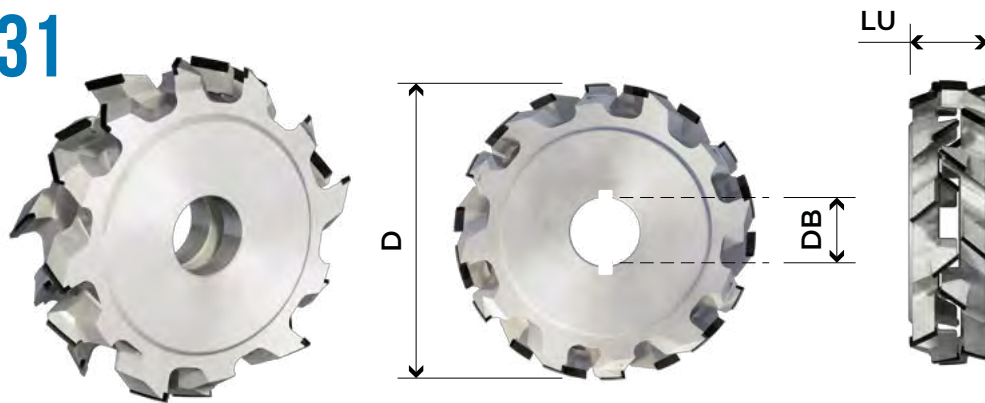

DIMENSIONI DIMENSIONS							ARTICOLI ITEMS		PREZZI €	
D	LU	Z EFF	Z TOT	DB	DKN	β°	H PCD	N. MAX	CODICE	PRICE €
DIAMETER	USEFUL LENGTH	ACTUAL TEETH	TOT. TEETH	HOLE DIAM.		AXIAL ANGLE	PCD HEIGHT	MAX R.P.M.	SKU	
80	25/38	3+3	12	30	2	45°	4,5	16.000	FFD4031001	
80	30/48	3+3	18	30	2	45°	4,5	16.000	FFD4031002	
100	25/38	3+3	12	30	2	45°	4,5	14.000	FFD4031003	
100	30/48	3+3	18	30	2	45°	4,5	14.000	FFD4031004	
125	25/38	3+3	12	30	2	45°	4,5	12.000	FFD4031005	
125	30/48	3+3	18	30	2	45°	4,5	12.000	FFD4031006	
180	25/38	5+5	20	35	2	45°	4,5	10.000	FFD4031007	
180	25/38	5+5	20	40	2	45°	4,5	10.000	FFD4031008	
180	25/38	6+6	24	35	2	45°	4,5	10.000	FFD4031009	
180	25/38	6+6	24	40	2	45°	4,5	10.000	FFD4031010	
180	30/48	5+5	30	35	2	45°	4,5	10.000	FFD4031011	
180	30/48	5+5	30	40	2	45°	4,5	10.000	FFD4031012	
180	30/48	6+6	36	35	2	45°	4,5	10.000	FFD4031013	
180	30/48	6+6	36	40	2	45°	4,5	10.000	FFD4031014	
200	25/38	5+5	20	35	2	45°	4,5	9.000	FFD4031015	
200	25/38	5+5	20	40	2	45°	4,5	9.000	FFD4031016	
200	25/38	6+6	24	35	2	45°	4,5	9.000	FFD4031017	
200	25/38	6+6	24	40	2	45°	4,5	9.000	FFD4031018	
200	25/38	8+8	32	35	2	45°	4,5	9.000	FFD4031019	
200	25/38	8+8	32	40	2	45°	4,5	9.000	FFD4031020	
200	30/48	5+5	30	35	2	45°	4,5	9.000	FFD4031021	
200	30/48	5+5	30	40	2	45°	4,5	9.000	FFD4031022	
200	30/48	6+6	36	35	2	45°	4,5	9.000	FFD4031023	
200	30/48	6+6	36	40	2	45°	4,5	9.000	FFD4031024	
200	30/48	8+8	48	35	2	45°	4,5	9.000	FFD4031025	
200	30/48	8+8	48	40	2	45°	4,5	9.000	FFD4031026	

TRS 2 FFD4032

FRESE RETTIFICA REGOLABILI
ASSIALITA' 54,9°

DIA ADJUSTABLE JOINTING
CUTTER CUTTING ANGLE 54,9°

Fresa in diamante riaffilabile per rettificare, composta da due elementi regolabili tramite spessori, adatta per lavorazioni di pannelli truciolari, nobilitati, rivestiti, laminati, impiallacciati, M.D.F., utilizzabile su macchine squadratrici.

Re-sharpening and adjustable jointing cutter in diamond, made in two pieces adjustable by spacer rings, used on squaring machines.

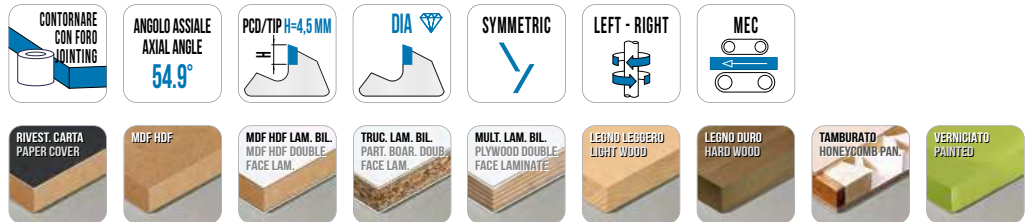
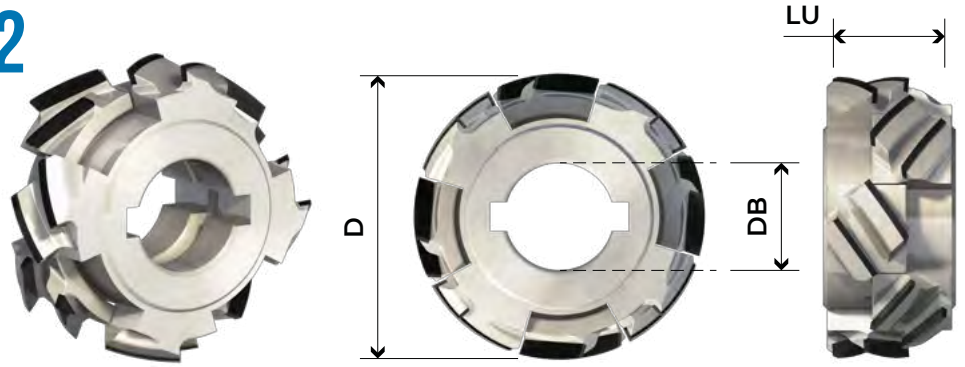

DIMENSIONI DIMENSIONS							ARTICOLI ITEMS		PREZZI €	
D	LU	Z EFF	Z TOT	DB	DKN	β°	H PCD	N. MAX	CODICE	PRICE €
DIAMETER	USEFUL LENGTH	ACTUAL TEETH	TOT. TEETH	HOLE DIAM.		AXIAL ANGLE	PCD HEIGHT	MAX R.P.M.	SKU	
80	25/38	3+3	18	30	2	54,9	4,5	16.000	FFD4032001	
80	30/48	3+3	18	30	2	54,9	4,5	16.000	FFD4032002	
100	25/38	3+3	18	30	2	54,9	4,5	14.000	FFD4032003	
100	30/48	3+3	18	30	2	54,9	4,5	14.000	FFD4032004	
125	25/38	3+3	18	30	2	54,9	4,5	12.000	FFD4032005	
125	30/48	3+3	18	30	2	54,9	4,5	12.000	FFD4032006	
180	25/38	5+5	30	35	2	54,9	4,5	10.000	FFD4032007	
180	25/38	5+5	30	40	2	54,9	4,5	10.000	FFD4032008	
180	25/38	6+6	36	35	2	54,9	4,5	10.000	FFD4032009	
180	25/38	6+6	36	40	2	54,9	4,5	10.000	FFD4032010	
180	30/48	5+5	30	35	2	54,9	4,5	10.000	FFD4032011	
180	30/48	5+5	30	40	2	54,9	4,5	10.000	FFD4032012	
180	30/48	6+6	36	35	2	54,9	4,5	10.000	FFD4032013	
180	30/48	6+6	36	40	2	54,9	4,5	10.000	FFD4032014	
200	25/38	5+5	30	35	2	54,9	4,5	9.000	FFD4032015	
200	25/38	5+5	30	40	2	54,9	4,5	9.000	FFD4032016	
200	25/38	6+6	36	35	2	54,9	4,5	9.000	FFD4032017	
200	25/38	6+6	36	40	2	54,9	4,5	9.000	FFD4032018	
200	25/38	8+8	48	35	2	54,9	4,5	9.000	FFD4032019	
200	25/38	8+8	48	40	2	54,9	4,5	9.000	FFD4032020	
200	30/48	5+5	30	35	2	54,9	4,5	9.000	FFD4032021	
200	30/48	5+5	30	40	2	54,9	4,5	9.000	FFD4032022	
200	30/48	6+6	36	35	2	54,9	4,5	9.000	FFD4032023	
200	30/48	6+6	36	40	2	54,9	4,5	9.000	FFD4032024	
200	30/48	8+8	48	35	2	54,9	4,5	9.000	FFD4032025	
200	30/48	8+8	48	40	2	54,9	4,5	9.000	FFD4032026	

TRS 4 FFD4033

FRESE RETTIFICA
INTERCAMBIABILE CON
REGOLAZIONE MICROMETRICA
HYDRO ASSIALITA' 45°

DIA ADJUSTABLE CHANGEABLE
JOINTING CUTTER
PROGRESSIVE WITH HYDRO
SLEEVE AXIAL 45°

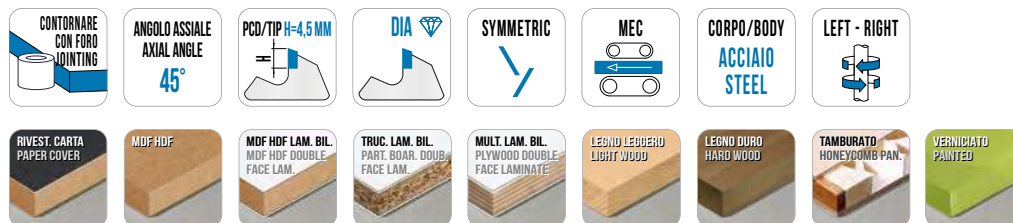
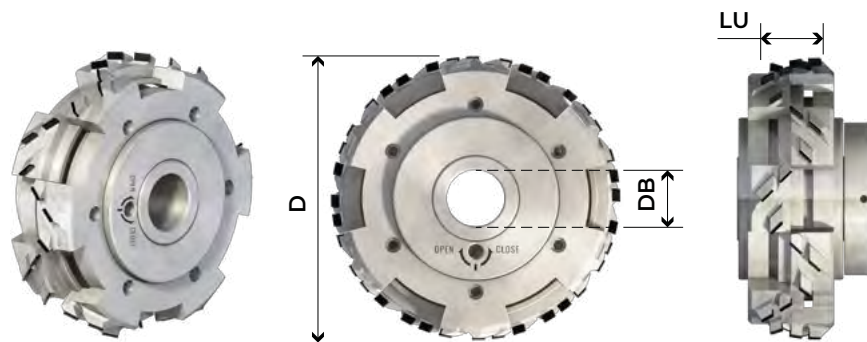

DIMENSIONI		DIMENSIONS		ARTICOLI ITEMS				PREZZI €	
D	LU	Z EFF	Z TOT	DB	β°	H PCD	N. MAX	CODICE	PREZZI €
DIAMETER	USEFUL LENGHT	ACTUAL TEETH	TOT. TEETH	HOLE DIAM.	AXIAL ANGLE	PCD HEIGHT	MAX R.P.M.	SKU	PRICE €
200	25/38	5+5	20	40	45°	4,5	9.000	FFD4033001	
200	25/38	6+6	24	40	45°	4,5	9.000	FFD4033002	
200	25/38	8+8	32	40	45°	4,5	9.000	FFD4033003	
200	30/48	5+5	30	40	45°	4,5	9.000	FFD4033004	
200	30/48	6+6	36	40	45°	4,5	9.000	FFD4033005	
200	30/48	8+8	48	40	45°	4,5	9.000	FFD4033006	

TRS 5 FFD4034

FRESE RETTIFICA
INTERCAMBIABILE CON
REGOLAZIONE MICROMETRICA
HYDRO ASSIALITA' 54,9°
CORPO IN ACCIAIO

DIA ADJUSTABLE CHANGEABLE
JOINTING CUTTER
PROGRESSIVE WITH HYDRO
SLEEVE AXIAL 54,9°
STEEL BODY

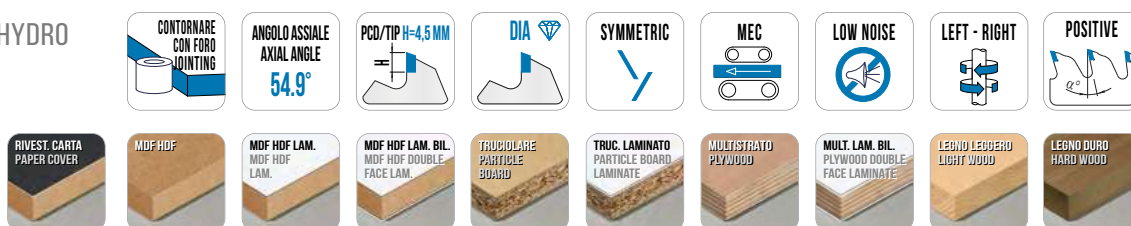
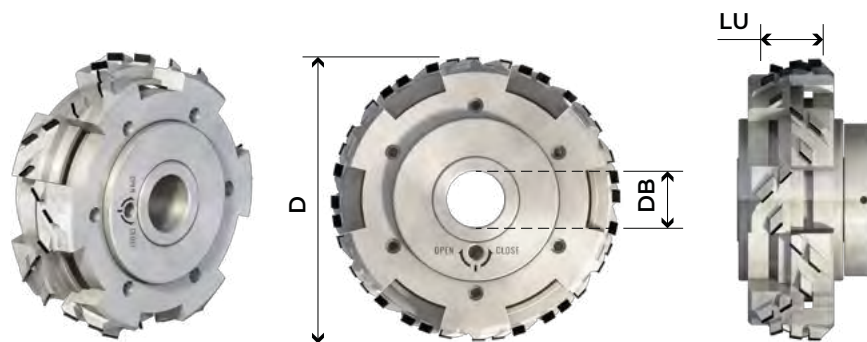

DIMENSIONI		DIMENSIONS		ARTICOLI ITEMS				PREZZI €	
D	LU	Z EFF	Z TOT	DB	β°	H PCD	N. MAX	CODICE	PREZZI €
DIAMETER	USEFUL LENGHT	ACTUAL TEETH	TOT. TEETH	HOLE DIAM.	AXIAL ANGLE	PCD HEIGHT	MAX R.P.M.	SKU	PRICE €
200	25/38	5+5	30	40	54,9	4,5	9.000	FFD4034001	
200	25/38	6+6	36	40	54,9	4,5	9.000	FFD4034002	
200	25/38	8+8	48	40	54,9	4,5	9.000	FFD4034003	
200	30/48	5+5	30	40	54,9	4,5	9.000	FFD4034004	
200	30/48	6+6	36	40	54,9	4,5	9.000	FFD4034005	
200	30/48	8+8	48	40	54,9	4,5	9.000	FFD4034006	

TRS 6 FFD4045

NEW

FRESE RETTIFICA
CON REGOLAZIONE
MICROMETRICA INDIPENDENTE
ASSILITA' 45°

DIA JOINTING CUTTERS WITH
INDIPENDENT MICROMETRIC
ADJUSTMENT CUTTING
ANGLE 45°

Fresa in diamante riaffilabile per rettificare composta da due elementi regolabili superiore/inferiore indipendenti tra loro, il sistema permette il bloccaggio e l'azzeramento della tolleranza tra il foro e il canotto. La fresa può avere configurazione simmetrica o asimmetrica.

Resharepeble PCD jointing cutter composed of two adjustable parts (upper / lower) independent each other. The system allows to lock and the tolerance reset between the hole and the hub. The cutter can be symmetrical or asymmetrical.

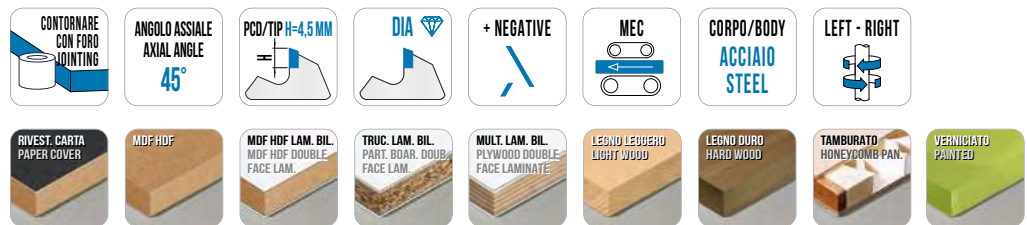
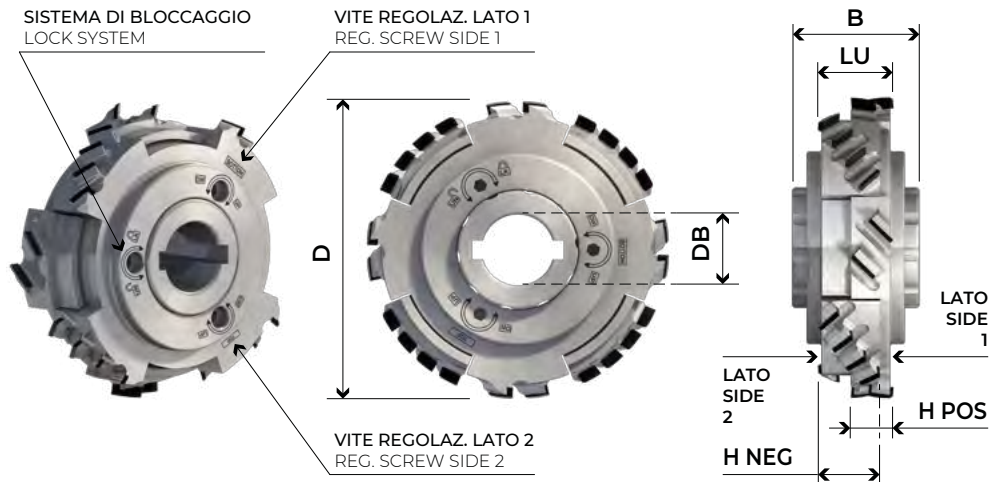

DIMENSIONI DIMENSIONS						ARTICOLI ITEMS		PREZZI €					
D	LU	Z EFF	Z TOT	DB	DKN	H POS	H NEG	B	β°	H PCD	SX / LH	DX / RH	PRICE €
DIAMETER	USEFUL LENGHT	ACTUAL TEETH	TOT. TEETH	HOLE DIAM.				THICK.	AXIAL ANGLE	PCD HEIGHT	CODICE / SKU	CODICE / SKU	
100	28/38	3+3	18	30	2	16	24	52	45°	4,5	FFD4045001	FFD4045002	
125	28/38	4+4	24	30	2	16	24	52	45°	4,5	FFD4045003	FFD4045004	
150	28/38	4+4	24	30	2	16	24	52	45°	4,5	FFD4045005	FFD4045006	

FRESE CON FORO - QUADRANTE BORDATRICE
CUTTERS WITH BORE - SQUARING EDGBANDING
FFD - FFS

GROOVINGCUT 2 FFD4035

FRESE REGOLABILI
PER CANALI

DIA ADJUSTABLE
GROOVING CUTTER

Fresa regolabile in diamante riaffilabile adatta per eseguire canali, utilizzabile su macchine bordatrici.

Re-sharpening adjustable grooving cutter in diamond, suitable for grooving on chipboard panels, used on edgebanding machines.

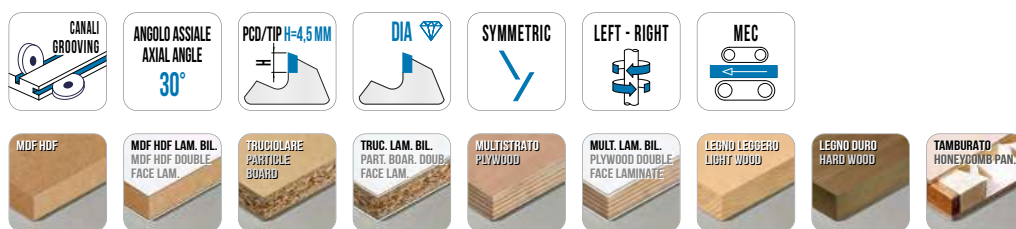
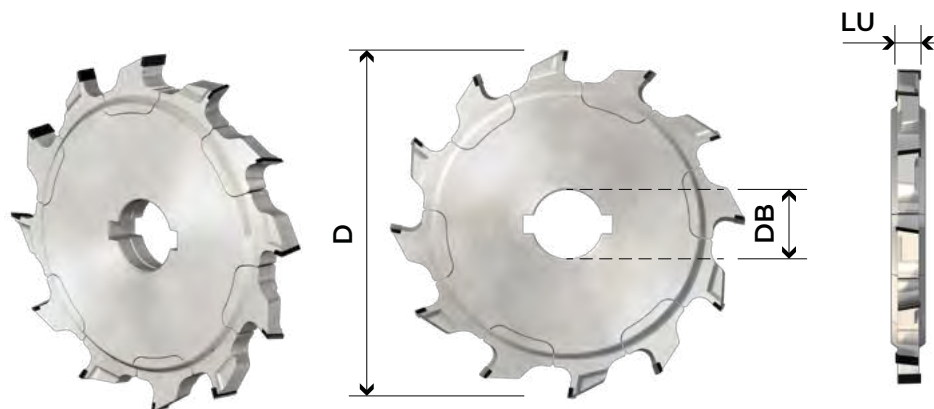

DIMENSIONI DIMENSIONS						ARTICOLI ITEMS		PREZZI €		
D	LU	Z EFF	Z TOT	DB	DKN	β°	H PCD	N. MAX	CODICE	PREZZI €
DIAMETER	USEFUL LENGHT	ACTUAL TEETH	TOT. TEETH	HOLE DIAM.		AXIAL ANGLE	PCD HEIGHT	MAX R.P.M.	SKU	PRICE €
120	4/7,5	8+8	16	35	2	5°	4,5	14.000	FFD4035001	
120	4/7,5	8+8	16	40	2	5°	4,5	14.000	FFD4035002	
120	6/11,5	8+8	16	35	2	5°	4,5	14.000	FFD4035003	
120	6/11,5	8+8	16	40	2	5°	4,5	14.000	FFD4035004	
160	4/7,5	8+8	16	35	2	5°	4,5	12.000	FFD4035005	
160	4/7,5	8+8	16	40	2	5°	4,5	12.000	FFD4035006	
160	6/11,5	8+8	16	35	2	5°	4,5	12.000	FFD4035007	
160	6/11,5	8+8	16	40	2	5°	4,5	12.000	FFD4035008	
180	4/7,5	8+8	16	35	2	5°	4,5	10.000	FFD4035009	
180	4/7,5	8+8	16	40	2	5°	4,5	10.000	FFD4035010	
180	6/11,5	8+8	16	35	2	5°	4,5	10.000	FFD4035011	
180	6/11,5	8+8	16	40	2	5°	4,5	10.000	FFD4035012	
200	4/7,5	8+8	16	35	2	5°	4,5	10.000	FFD4035013	
200	4/7,5	8+8	16	40	2	5°	4,5	10.000	FFD4035014	
200	6/11,5	8+8	16	35	2	5°	4,5	10.000	FFD4035015	
200	6/11,5	8+8	16	40	2	5°	4,5	10.000	FFD4035016	
200	4/7,5	12+12	24	35	2	5°	4,5	10.000	FFD4035017	
200	4/7,5	12+12	24	40	2	5°	4,5	10.000	FFD4035018	
200	6/11,5	12+12	24	35	2	5°	4,5	10.000	FFD4035019	
200	6/11,5	12+12	24	40	2	5°	4,5	10.000	FFD4035020	

GROOVINGCUT 4 FFD4046

NEW

FRESE REGOLABILI PER
CANALI AD ELEMENTI
INTERCAMBIABILI

DIA ADJUSTABLE GROOVING
SAW WITH INTERCHANGEABLE
ELEMENTS

Fresa regolabile in diamante
riaffilabile ad elementi
intercambiabili montati su
mandrino portafresa con
regolazione micrometrica
decimale senza l'utilizzo di
spessori.

Re-sharpening grooving
cutter in diamond, with
interchangeable elemets (body)
fit on hub with micrometric
adjustment without additional
spacers.

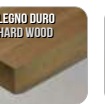
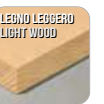
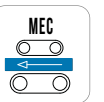
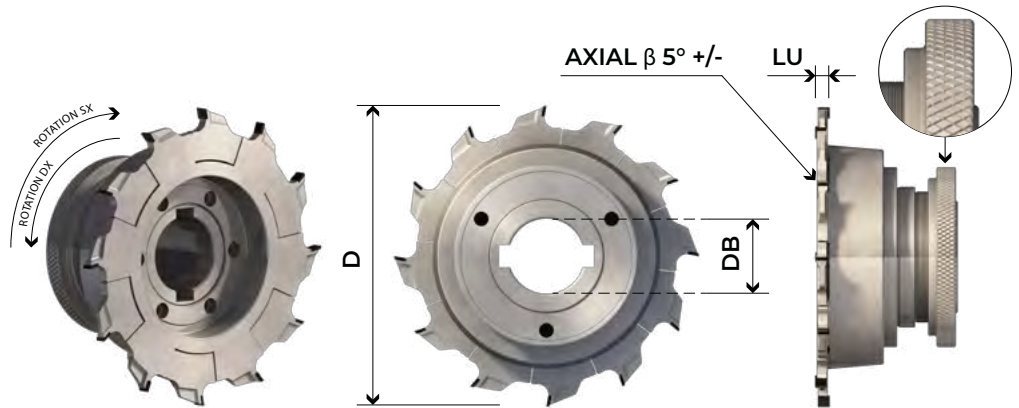

DIMENSIONI		DIMENSIONS		ARTICOLI ITEMS						PREZZI €
D	LU	Z EFF	Z TOT	DB	DKN	β°	H PCD	SX / LH	DX / RH	PRICE €
DIAMETER	USEFUL LENGHT	ACTUAL TEETH	TOT. TEETH	HOLE DIAM.		AXIAL ANGLE	PCD HEIGHT	CODICE / SKU	CODICE / SKU	
160	4/7,5	6+6	12	40	2	5°	4,5	FFD4046001	FFD4046002	
160	4/7,5	8+8	16	40	2	5°	4,5	FFD4046003	FFD4046004	
160	6/11,5	6+6	12	40	2	5°	4,5	FFD4046005	FFD4046006	
160	6/11,5	8+8	16	40	2	5°	4,5	FFD4046007	FFD4046008	
180	4/7,5	6+6	12	40	2	5°	4,5	FFD4046009	FFD4046010	
180	4/7,5	6+6	16	40	2	5°	4,5	FFD4046011	FFD4046012	
180	6/11,5	8+8	12	40	2	5°	4,5	FFD4046013	FFD4046014	
180	6/11,5	8+8	16	40	2	5°	4,5	FFD4046015	FFD4046016	

FFD - FFS
FRESE CON FORO - QUADRATICE BORDATRICE
CUTTERS WITH BORE - SQUARING EDGBANDING

GROOVINGCUT 3 FFD4036

FRESE REGOLABILI
PER CANALI CON SPIGOLATORI
REGOLABILI

DIA ADJUSTABLE GROOVING
CUTTER WITH ADJUSTABLE
CHANFERING KNIFE

Fresa regolabile in diamante
riaffilabile con spigolatori
regolabili passo/passò in
profondità, per eseguire canali su
pannelli, utilizzabile su macchine
bordatrici.

Re-sharpening adjustable
grooving cutter in diamond
with adjustable chanfering
knife, suitable for grooving
on chipboard panels, used on
edgebanding machines.

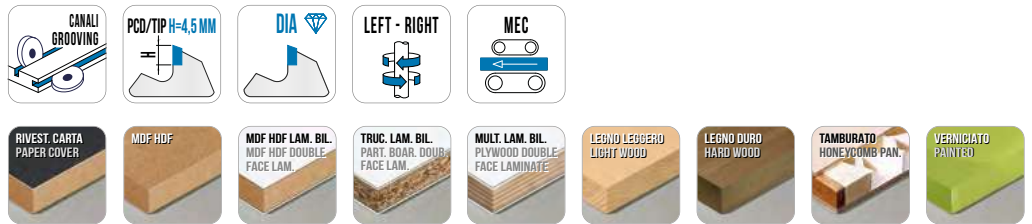
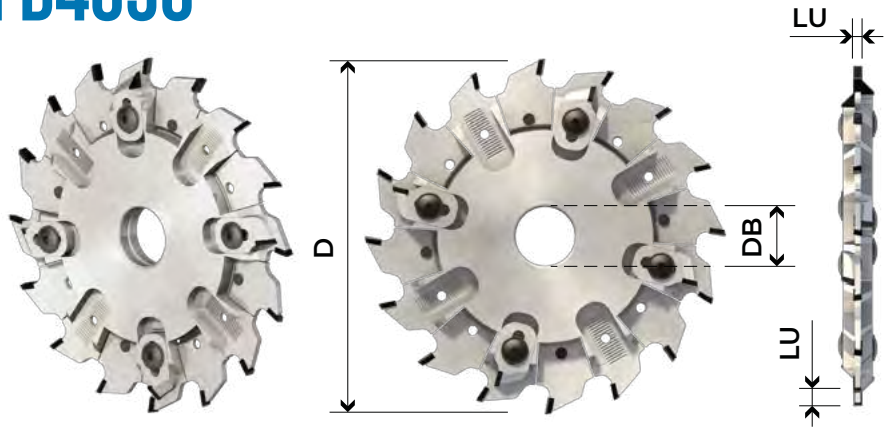

DIMENSIONI DIMENSIONS							ARTICOLI ITEMS		PREZZI €	
D DIAMETER	LU USEFUL LENGHT	Z EFF ACTUAL TEETH	Z TOT TOT. TEETH	DB HOLE DIAM.	DKN	β° AXIAL ANGLE	H PCD PCD HEIGHT	N. MAX MAX R.P.M.	CODICE SKU	PRICE €
120	4/7,5	6+6+3+3	18	35	2	0°	4,5	14.000	FFD4036001	
120	4/7,5	6+6+3+3	18	40	2	0°	4,5	14.000	FFD4036002	
120	6/11,5	6+6+3+3	18	35	2	0°	4,5	14.000	FFD4036003	
120	6/11,5	6+6+3+3	18	40	2	0°	4,5	14.000	FFD4036004	
160	4/7,5	8+8+4+4	24	35	2	0°	4,5	12.000	FFD4036005	
160	4/7,5	8+8+4+4	24	40	2	0°	4,5	12.000	FFD4036006	
160	6/11,5	8+8+4+4	24	35	2	0°	4,5	12.000	FFD4036007	
160	6/11,5	8+8+4+4	24	40	2	0°	4,5	12.000	FFD4036008	
180	4/7,5	10+10+5+5	30	35	2	0°	4,5	10.000	FFD4036009	
180	4/7,5	10+10+5+5	30	40	2	0°	4,5	10.000	FFD4036010	
180	6/11,5	10+10+5+5	30	35	2	0°	4,5	10.000	FFD4036011	
180	6/11,5	10+10+5+5	30	40	2	0°	4,5	10.000	FFD4036012	

FFD4029 BIESSE HOMAG BRANDT

FRESE BORDATRICI
PER RIFILARE

PRE FINISHING EDGE
TRIMMING CUTTER

Per lavorare bordi incollati di
legni massicci, legni teneri o
duri e materie plastiche su
macchine bordatrici BIESSE,
BRANDT E HOMAG.

PCD cutter to trim edge in solid
wood, soft and hard wood as
well as abs or plastic edges
on edgebanding machines
BIESSE, BRANDT E HOMAG.

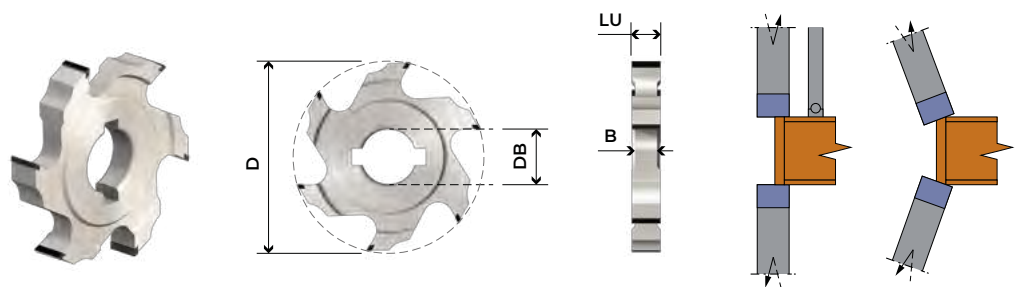

DIMENSIONI DIMENSIONS							MACCHINA		ARTICOLI ITEMS		PREZZI €
D DIAMETER	LU USEFUL LENGHT	Z EFF ACTUAL TEETH	Z TOT TOT. TEETH	DB HOLE DIAM.	DKN	β° AXIAL ANGLE	H PCD PCD HEIGHT	B THICKNESS	MACHINE BRANDS	CODICE SKU	PRICE €
70	10	4	4	16	2	0°	2,5	10	BIESSE - HOMAG - BRANDT	FFD4029001	
70	10	4	4	16	2	0°	4,5	10	BIESSE - HOMAG - BRANDT	FFD4029002	
70	10	6	6	16	2	0°	2,5	10	BIESSE - HOMAG - BRANDT	FFD4029003	
70	10	6	6	16	2	0°	4,5	10	BIESSE - HOMAG - BRANDT	FFD4029004	

FFD4037 HOMAG IMA

FRESE BORDATRICI PER CONTORNARE CON HSK25R

PRE FINISHING EDGE TRIMMING CUTTER HSK

Per lavorare bordi incollati di legni massicci, legni teneri o duri e materie plastiche su macchine bordatrici HOMAG - IMA.

To trim edgebandings on horizontal spindles or for bevelling with inclined spindles, for jointing and flush-cutting of solid wood, veneer and plastic edge bands for machines HOMAG - IMA.

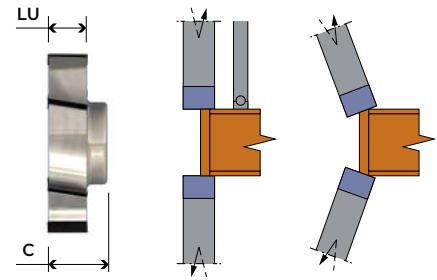
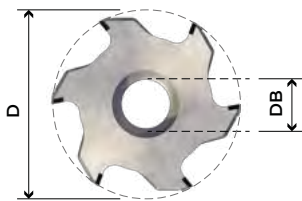

FINITURA BORDO
EDGE FINISHING

PCD/TIP H=4MM

DIA

ANGOLO ASSIALE
AXIAL ANGLE
10°

R.P.M. MAX
18.000

MEC

RIVEST. CARTA
PAPER COVER

MDF HDF LAM. BIL.
MDF HDF DOUBLE
FACE LAM.

TRUC. LAM. BIL.
PART. BOAR. DOUB.
FACE LAM.

MULT. LAM. BIL.
PLYWOOD DOUBLE
FACE LAMINATE

DIMENSIONI		DIMENSIONS		MACCHINA			ARTICOLI ITEMS		PREZZI €
D	LU	Z EFF	DB	C	β°	H PCD	SX / LH	DX / RH	PRICE €
DIAMETER	USEFUL LENGTH	ACTUAL TEETH	HOLE DIAM.	THICKNESS	AXIAL ANGLE	PCD HEIGHT	CODICE / SKU	CODICE / SKU	
70	10	4	HSK25R	23	10°	4	HOMAG - IMA	FFD4037001	FFD4037002
70	15	4	HSK25R	23	10°	4	HOMAG - IMA	FFD4037003	FFD4037004
70	10	6	HSK25R	23	10°	4	HOMAG - IMA	FFD4037005	FFD4037006
70	15	6	HSK25R	23	10°	4	HOMAG - IMA	FFD4037007	FFD4037008
70	10	8	HSK25R	23	10°	4	HOMAG - IMA	FFD4037009	FFD4037010
70	15	8	HSK25R	23	10°	4	HOMAG - IMA	FFD4037011	FFD4037012

FFD4038 STEFANI FRAVOL

FRESE BORDATRICI PER CONTORNARE MACCHINA STEFANI-FRAVOL

PRE FINISHING EDGE TRIMMING CUTTER STEFANI-FRAVOL MACHINES

Per lavorare bordi incollati di legni massicci, legni teneri o duri e materie plastiche su macchine bordatrici STEFANI FRAVOL.

To trim edgebandings on horizontal spindles or for bevelling with inclined spindles, for jointing and flush-cutting of solid wood, veneer and plastic edge bands for machines STEFANI-FRAVOL.

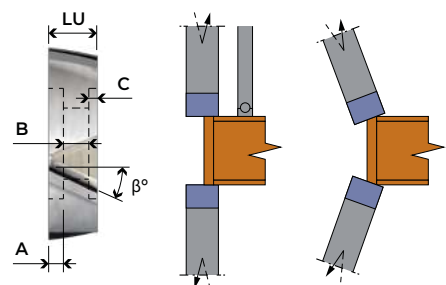
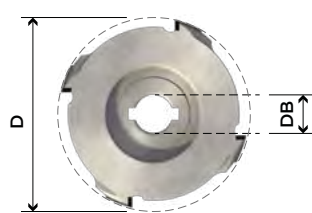

FINITURA BORDO
EDGE FINISHING

PCD/TIP H=4MM

DIA

R.P.M. MAX
18.000

LOW NOISE

MEC

RIVEST. CARTA
PAPER COVER

MDF HDF LAM. BIL.
MDF HDF DOUBLE
FACE LAM.

TRUC. LAM. BIL.
PART. BOAR. DOUB.
FACE LAM.

MULT. LAM. BIL.
PLYWOOD DOUBLE
FACE LAMINATE

DIMENSIONI		DIMENSIONS		MACCHINA			ARTICOLI ITEMS		PREZZI €				
D	LU	Z EFF	DB	DKN	A	B	C	β°	H PCD	MACHINE BRANDS	SX / LH	DX / RH	PRICE €
DIAMETER	USEFUL L.	ACTUAL TEETH	HOLE DIAM.					AXIAL ANGLE	PCD HEIGHT		CODICE / SKU	CODICE / SKU	
80	20	4	16	2	6,5	11	2,5	25°	4	STEFANI	FFD4038001	FFD4038002	
80	30	4	20	2	0	26,5	3,5	15°	4	FRAVOL	FFD4038003	FFD4038004	

FFD4040 HOMAG IMA

FRESE BORDATRICI PER
CONTORNARE CON HSK25R
PER HOMAG-IMA

PRE FINISHING EDGE TRIM-
MING CUTTER HSK25R FOR
HOMAG-IMA

Per lavorare bordi incollati di legni massicci, legni teneri o duri e materie plastiche su macchine bordatrici HOMAG - IMA.

To trim edgebandings on horizontal spindles or for bevelling with inclined spindles, for jointing and flush-cutting of solid wood, veneer and plastic edge bands for machines HOMAG - IMA.

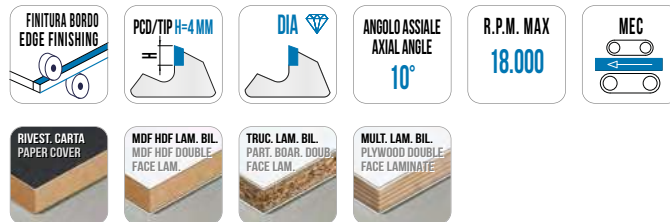
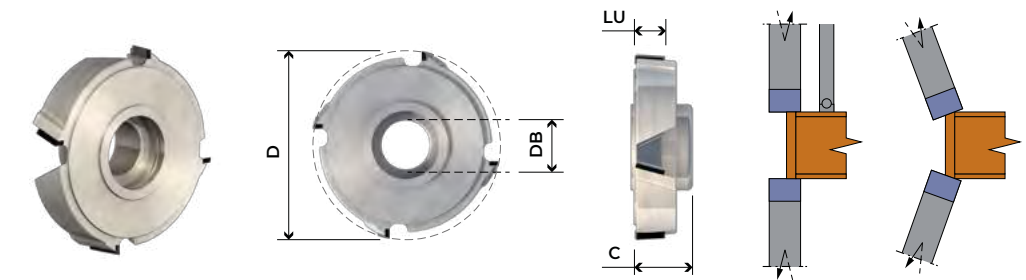

DIMENSIONI DIMENSIONS		MACCHINA		ARTICOLI ITEMS		PREZZI €				
D	LU	Z EFF	DB	C	β°	H PCD	MACHINE BRANDS	SX / LH CODICE / SKU	DX / RH CODICE / SKU	PRICE €
DIAMETER	USEFUL LENGHT	ACTUAL TEETH	HOLE DIAM.	THICKNESS	AXIAL ANGLE	PCD HEIGHT				
70	10	4	HSK25R	23	10°	4	HOMAG - IMA	FFD4040001	FFD4040002	
70	15	4	HSK25R	23	10°	4	HOMAG - IMA	FFD4040003	FFD4040004	
70	10	6	HSK25R	23	10°	4	HOMAG - IMA	FFD4040005	FFD4040006	
70	15	6	HSK25R	23	10°	4	HOMAG - IMA	FFD4040007	FFD4040008	
70	10	8	HSK25R	23	10°	4	HOMAG - IMA	FFD4040009	FFD4040010	
70	15	8	HSK25R	23	10°	4	HOMAG - IMA	FFD4040011	FFD4040012	

FFD4044

FRESE PER BATTUTE PCD H4,5
ASSIALE POSITIVO NEGATIVO

PCD REBATING CUTTER POS/
NEG AXIAL CUT PCD H 4,5

Fresa in diamante per battute ideale per toupie e macchine scorniciatrici. PCD H4,5 con 8 affilature e angolo assiale positivo negativo per finitura massima sui bordi.

PCD rebating cutter to be use on spindle moulder edgebander machine pcd h 4,5 mm 8 times resharpening with pos/neg cutting angle for better finishing on all edges.

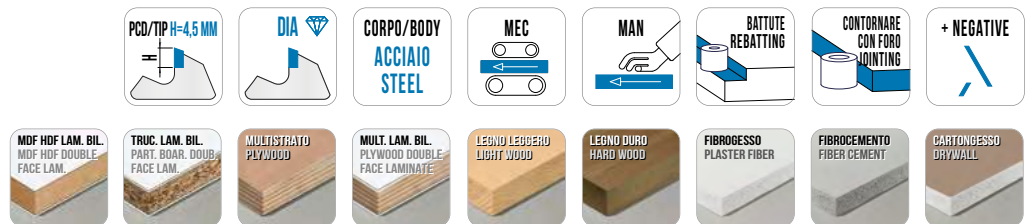
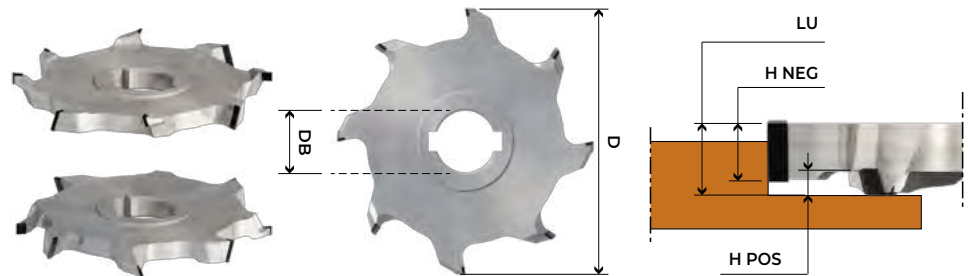

DIMENSIONI DIMENSIONS					ARTICOLI ITEMS					PREZZI €
D	LU	Z EFF	DB	Z TOT	DKN	H POS	H NEG	SX / LH CODICE / SKU	DX / RH CODICE / SKU	PRICE €
DIAMETER	USEFUL LENGHT	ACTUAL TEETH	HOLE DIAM.	TOT. TEETH						
150	15	4	30	8	2	5	10	FFD4044001	FFD4044002	
150	20	4	30	8	2	5	15	FFD4044003	FFD4044004	
150	15	4	35	8	2	5	10	FFD4044005	FFD4044006	
150	20	4	35	8	2	5	15	FFD4044007	FFD4044008	
150	15	4	40	8	2	5	10	FFD4044009	FFD4044010	
150	20	4	40	8	2	5	15	FFD4044011	FFD4044012	
150	15	6	30	12	2	5	10	FFD4044013	FFD4044014	
150	20	6	30	12	2	5	15	FFD4044015	FFD4044016	
150	15	6	35	12	2	5	10	FFD4044017	FFD4044018	
150	20	6	35	12	2	5	15	FFD4044019	FFD4044020	
150	15	6	40	12	2	5	10	FFD4044021	FFD4044022	
150	20	6	40	12	2	5	15	FFD4044023	FFD4044024	

FFS5001 HOLZ-HER

FRESA BORDATRICE
IN DIAMANTE RAGGIATRICI
PER MACCHINA HOLZ-HER

DIAMOND EDGE ROUNDING
CUTTERS FOR HOLZ-HER

Per raggare bordi incollati di legni massicci, legni teneri o duri e materie plastiche su macchine bordatrici HOLZ-HER

For rounding solid wood, veneer and plastic edge bands for HOLZ-HER machine.

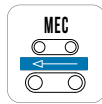
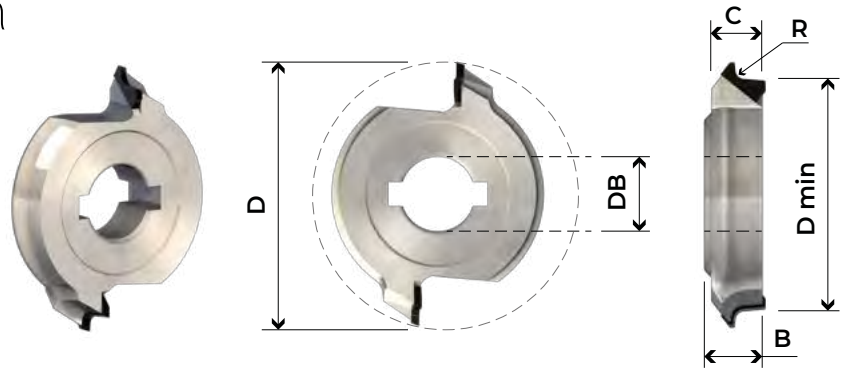

DIMENSIONI		DIMENSIONS		MACCHINA						ARTICOLI ITEMS		PREZZI €
D	Dmin	R	Z EFF	DB	DKN	H PCD	B	C	MACHINE BRANDS	SX / LH	DX / RH	PRICE €
DIAMETER	MIN DIAM.	RADIUS	ACTUAL TEETH	HOLE DIAM.		PCD HEIGHT	THICKNESS	THICKNESS		CODICE / SKU	CODICE / SKU	
57	50	0,5	2	16	2	4	12,5	11	HOLZ-HER	FFS5001001	FFS5001002	
57	50	1	2	16	2	4	12,5	11	HOLZ-HER	FFS5001003	FFS5001004	
57	50	1,5	2	16	2	4	12,5	11	HOLZ-HER	FFS5001005	FFS5001006	
57	50	2	2	16	2	4	12,5	11	HOLZ-HER	FFS5001007	FFS5001008	
57	50	2,5	2	16	2	4	12,5	11	HOLZ-HER	FFS5001009	FFS5001010	
57	50	3	2	16	2	4	12,5	11	HOLZ-HER	FFS5001011	FFS5001012	

FFS5002 HOLZ-HER

FRESE BORDATRICI IN
DIAMANTE PER RAGGIARE
MACCHINA HOLZ-HER 1832
CON AIR SYSTEM

DIAMOND EDGE ROUNDING
CUTTERS FOR HOLZ-HER 1832
WITH AIR SYSTEM

Per raggare bordi incollati di legni massicci, legni teneri o duri e materie plastiche su macchine bordatrici HOLZ-HER 1832 con AIR SYSTEM

For rounding solid wood, veneer and plastic edge bands for HOLZ-HER 1832 with AIR SYSTEM

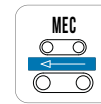
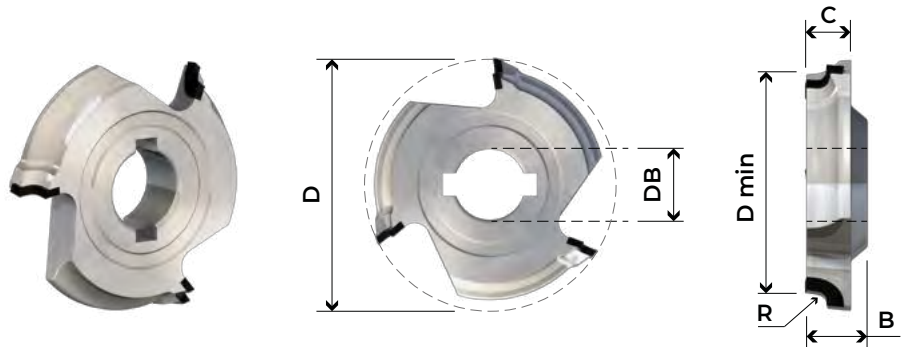

DIMENSIONI		DIMENSIONS		MACCHINA						ARTICOLI ITEMS		PREZZI €
D	Dmin	R	Z EFF	DB	DKN	H PCD	B	C	MACHINE BRANDS	SX / LH	DX / RH	PRICE €
DIAMETER	MIN DIAM.	RADIUS	ACTUAL TEETH	HOLE DIAM.		PCD HEIGHT	THICKNESS	THICKNESS		CODICE / SKU	CODICE / SKU	
58,7	50	0,5	3	16	2	4	12	8,5	HOLZ-HER	FFS5002001	FFS5002002	
58,7	50	1	3	16	2	4	12	8,5	HOLZ-HER	FFS5002003	FFS5002004	
58,7	50	1,5	3	16	2	4	12	8,5	HOLZ-HER	FFS5002005	FFS5002006	
58,7	50	2	3	16	2	4	12	8,5	HOLZ-HER	FFS5002007	FFS5002008	
58,7	50	2,5	3	16	2	4	12	8,5	HOLZ-HER	FFS5002009	FFS5002010	
58,7	50	3	3	16	2	4	12	8,5	HOLZ-HER	FFS5002011	FFS5002012	

FFS5003 HOLZ-HER

FRESA BORDATRICE
IN DIAMANTE RAGGIATRICI
PER MACCHINA HOLZ-HER
1827

DIAMOND EDGE ROUNDING
CUTTERS FOR HOLZ-HER 1827

Per raggare bordi incollati di legni massicci, legni teneri o duri e materie plastiche su macchine bordatrici HOLZ-HER 1827.

For rounding solid wood, veneer and plastic edge bands for HOLZ-HER 1827.

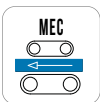
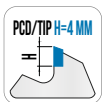
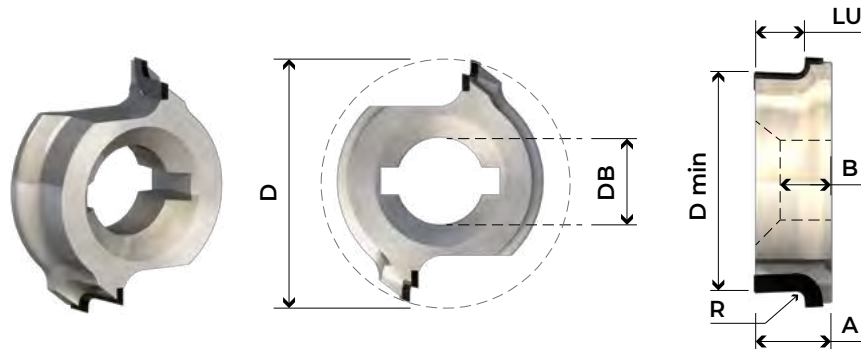

DIMENSIONI DIMENSIONS				MACCHINA						ARTICOLI ITEMS		PREZZI €	
D	Dmin	R	Z EFF	DB	DKN	LU	H PCD	B	A	MACHINE BRANDS	SX / LH CODICE / SKU	DX / RH CODICE / SKU	PRICE €
DIAMETER	MIN DIAM.	RADIUS	ACTUAL TEETH	HOLE DIAM.	DKN	USEFUL L.	PCD HEIGHT	THICK.	THICK.				
56	50	0,5	2	20	2	11	4	11,5	17,2	HOLZ-HER	FFS5003001	FFS5003002	
56	50	1	2	20	2	11	4	11,5	17,2	HOLZ-HER	FFS5003003	FFS5003004	
56	50	1,5	2	20	2	11	4	11,5	17,2	HOLZ-HER	FFS5003005	FFS5003006	
56	50	2	2	20	2	11	4	11,5	17,2	HOLZ-HER	FFS5003007	FFS5003008	
56	50	2,5	2	20	2	11	4	11,5	17,2	HOLZ-HER	FFS5003009	FFS5003010	
56	50	3	2	20	2	11	4	11,5	17,2	HOLZ-HER	FFS5003011	FFS5003012	

FFS5004 HOLZ-HER

FRESA BORDATRICE
IN DIAMANTE RAGGIATRICI
PER MACCHINA HOLZ-HER
FR201 CON AIR SYSTEM

DIAMOND EDGE ROUNDING
CUTTERS FOR HOLZ-HER
FR201 WITH AIR SYSTEM

Per raggare bordi incollati di legni massicci, legni teneri o duri e materie plastiche su macchine bordatrici HOLZ-HER FR201 CON AIR SYSTEM..

For rounding solid wood, veneer and plastic edge bands for HOLZ-HER FR201 with AIR SYSTEM.

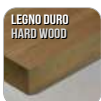
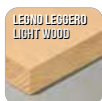
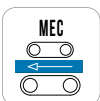
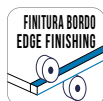
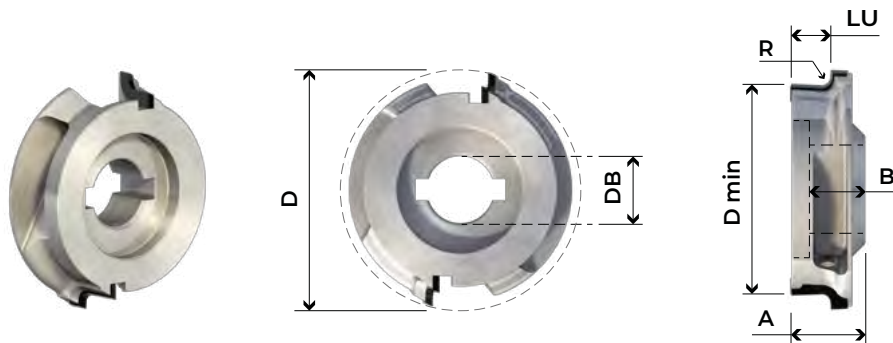

DIMENSIONI DIMENSIONS				MACCHINA						ARTICOLI ITEMS		PREZZI €	
D	Dmin	R	Z EFF	DB	DKN	LU	H PCD	B	A	MACHINE BRANDS	SX / LH CODICE / SKU	DX / RH CODICE / SKU	PRICE €
DIAMETER	MIN DIAM.	RADIUS	ACTUAL TEETH	HOLE DIAM.	DKN	USEFUL L.	PCD HEIGHT	THICK.	THICK.				
57	50	0,5	2	16	2	9	4	12,5	17	HOLZ-HER	FFS5004001	FFS5004002	
57	50	1	2	16	2	9	4	12,5	17	HOLZ-HER	FFS5004003	FFS5004004	
57	50	1,5	2	16	2	9	4	12,5	17	HOLZ-HER	FFS5004005	FFS5004006	
57	50	2	2	16	2	9	4	12,5	17	HOLZ-HER	FFS5004007	FFS5004008	
57	50	2,5	2	16	2	9	4	12,5	17	HOLZ-HER	FFS5004009	FFS5004010	
57	50	3	2	16	2	9	4	12,5	17	HOLZ-HER	FFS5004011	FFS5004012	

FFS5005 HOLZ-HER

FRESE BORDATRICI
IN DIAMANTE PER RAGGIARE
MACCHINA HOLZ-HER 1833
CON AIR SYSTEM

DIAMOND EDGE ROUNDING
CUTTERS FOR HOLZ-HER 1833
WITH AIR SYSTEM

Per raggiare bordi incollati di legni massicci, legni teneri o duri e materie plastiche su macchine bordatrici HOLZ-HER 1833 con AIR SYSTEM.

For rounding solid wood, veneer and plastic edge bands for HOLZ-HER 1833 WITH AIR SYSTEM.

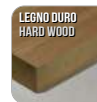
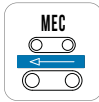
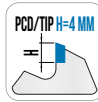
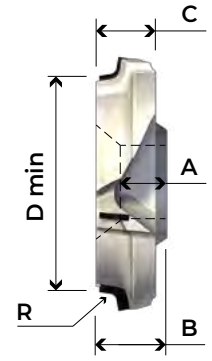
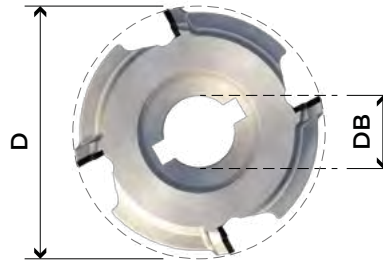

DIMENSIONI		DIMENSIONS		MACCHINA							ARTICOLI ITEMS		PREZZI €
D	Dmin	R	Z EFF	DB	DKN	H PCD	A	B	C	MACHINE BRANDS	SX / LH	DX / RH	PRICE €
DIAMETER	MIN DIAM.	RADIUS	ACTUAL TEETH	HOLE DIAM.	DKN	PCD HEIGHT	THICK.	THICK.	THICK.		CODICE / SKU	CODICE / SKU	
72,5	61	0,5	4	20	2	4	11,5	19	16	HOLZ-HER	FFS5005001	FFS5005002	
72,5	61	1	4	20	2	4	11,5	19	16	HOLZ-HER	FFS5005003	FFS5005004	
72,5	61	1,5	4	20	2	4	11,5	19	16	HOLZ-HER	FFS5005005	FFS5005006	
72,5	61	2	4	20	2	4	11,5	19	16	HOLZ-HER	FFS5005007	FFS5005008	
72,5	61	2,5	4	20	2	4	11,5	19	16	HOLZ-HER	FFS5005009	FFS5005010	
72,5	61	3	4	20	2	4	11,5	19	16	HOLZ-HER	FFS5005011	FFS5005012	

FFS5006 HOLZ-HER

FRESA BORDATRICE
IN DIAMANTE PER RAGGIARE
E SMUSSARE PER MACCHINA
HOLZ-HER 1826

DIAMOND EDGE ROUNDING
AND CHAMFERING CUTTERS
FOR HOLZ-HER 1826

Per raggiare e smussare bordi incollati di legni massicci, legni teneri o duri e materie plastiche su macchine bordatrici HOLZ-HER 1826.

For rounding and chamfering and rounding solid wood, veneer and plastic edge bands for HOLZ-HER 1826.

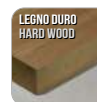
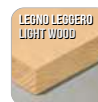
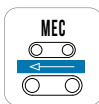
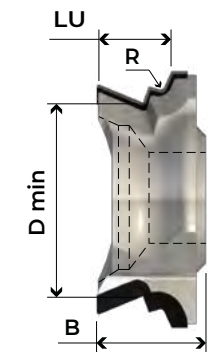
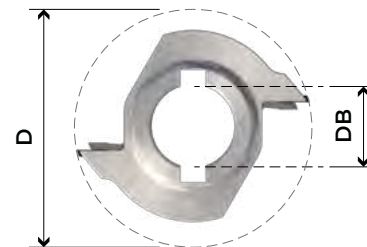

DIMENSIONI		DIMENSIONS		MACCHINA							ARTICOLI ITEMS		PREZZI €
D	Dmin	R	Z EFF	DB	DKN	LU	H PCD	B	A	MACHINE BRANDS	SX / LH	DX / RH	PRICE €
DIAMETER	MIN DIAM.	RADIUS	ACTUAL TEETH	HOLE DIAM.	DKN	USEFUL L.	PCD HEIGHT	THICK.	THICK.		CODICE / SKU	CODICE / SKU	
57,25	43,8	0,5	2	20	2	16	4	23	12	HOLZ-HER	FFD5006001	FFD5006002	
57,25	43,8	1	2	20	2	16	4	23	12	HOLZ-HER	FFD5006003	FFD5006004	
57,25	43,8	1,5	2	20	2	16	4	23	12	HOLZ-HER	FFD5006005	FFD5006006	
57,25	43,8	2	2	20	2	16	4	23	12	HOLZ-HER	FFD5006007	FFD5006008	
57,25	43,8	2,5	2	20	2	16	4	23	12	HOLZ-HER	FFD5006009	FFD5006010	
57,25	43,8	3	2	20	2	16	4	23	12	HOLZ-HER	FFD5006011	FFD5006012	

FFS5007 HOLZ-HER

FRESA BORDATRICE
IN DIAMANTE RAGGIATRICI
PER MACCHINA HOLZ-HER
FR701

DIAMOND EDGE ROUNDING
AND CHAMFERING CUTTERS
FOR HOLZ-HER FR701

Per raggiare e smussare bordi incollati di legni massicci, legni teneri o duri e materie plastiche su macchine bordatrici HOLZ-HER FR701.

For rounding and chamfering and rounding solid wood, veneer and plastic edge bands for HOLZ-HER FR701.

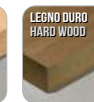
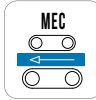
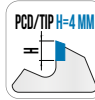
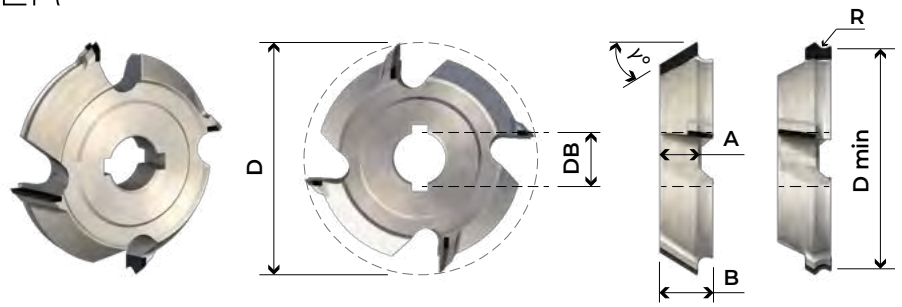

DIMENSIONI		DIMENSIONS		MACCHINA		ARTICOLI ITEMS		PREZZI €						
D	Dmin	R	Z EFF	DB	DKN	LU	H PCD	B	A	γ°	MACHINE BRANDS	SX / LH CODICE / SKU	DX / RH CODICE / SKU	PRICE €
DIAM.	MIN DIAM.	RADIUS	ACTUAL TEETH	HOLE DIAM.		US. LENGTH	PCD HEIGHT	THICK.	THICK.	Range				
72	68	0,5	2	16	2	16	4	16	12,5	30°	HOLZ-HER	FFS5007001	FFS5007002	
72	68	1	2	16	2	16	4	16	12,5	30°	HOLZ-HER	FFS5007003	FFS5007004	
72	68	1,5	2	16	2	16	4	16	12,5	30°	HOLZ-HER	FFS5007005	FFS5007006	
72	68	2	2	16	2	16	4	16	12,5	30°	HOLZ-HER	FFS5007007	FFS5007008	
72	68	2,5	2	16	2	16	4	16	12,5	30°	HOLZ-HER	FFS5007009	FFS5007010	
72	68	3	2	16	2	16	4	16	12,5	30°	HOLZ-HER	FFS5007011	FFS5007012	

FFS5008 HOLZ-HER

FRESE BORDATRICI
IN DIAMANTE PER RAGGIARE
MACCHINA SCM - STEFANI
ROUNDK AIR SYSTEM Z3

DIAMOND EDGE ROUNDING
CUTTERS FOR SCM - STEFANI
ROUNDK AIR SYSTEM Z3

Per raggiare bordi incollati di legni massicci, legni teneri o duri e materie plastiche su macchine bordatrici SCM - STEFANI ROUNDK AIR SYSTEM Z3

For rounding solid wood, veneer and plastic edge bands for SCM - STEFANI ROUNDK AIR SYSTEM Z3

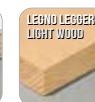
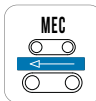
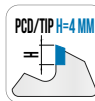
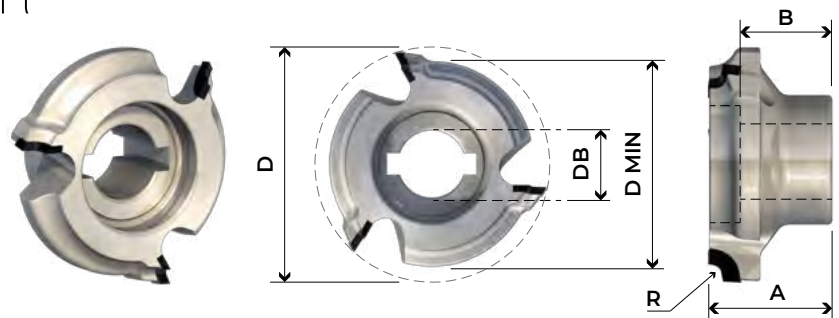

DIMENSIONI		DIMENSIONS		MACCHINA		ARTICOLI ITEMS		PREZZI €				
D	D MIN	R	Z EFF	DB	DKN	H PCD	B	A	MACHINE BRANDS	SX / LH CODICE / SKU	DX / RH CODICE / SKU	PRICE €
DIAMETER	DIAMETER	RADIUS	ACTUAL TEETH	HOLE DIAM.		PCD HEIGHT	THICKNESS	THICKNESS				
55,7	49,9	0,5	3	16	2	4	20	26,7	SCM STEFANI	FFS5008001	FFS5008002	
55,7	49,9	1	3	16	2	4	20	26,7	SCM STEFANI	FFS5008003	FFS5008004	
55,7	50,9	1,5	3	16	2	4	20	26,7	SCM STEFANI	FFS5008005	FFS5008006	
55,7	51,9	2	3	16	2	4	20	26,7	SCM STEFANI	FFS5008007	FFS5008008	
55,7	51,9	2,5	3	16	2	4	20	26,7	SCM STEFANI	FFS5008009	FFS5008010	
55,7	53,9	3	3	16	2	4	20	26,7	SCM STEFANI	FFS5008011	FFS5008012	

MFX 10 FFS5018 HOMAG IMA

NEW

FRESA BORATRICE
PORTAINSERTI
INTERCAMBIABILI
IN DIAMANTE
PCD INSERTS
EDGE BANDER CUTTER

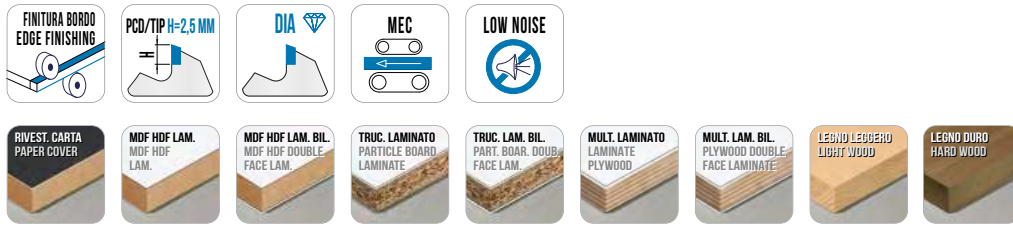
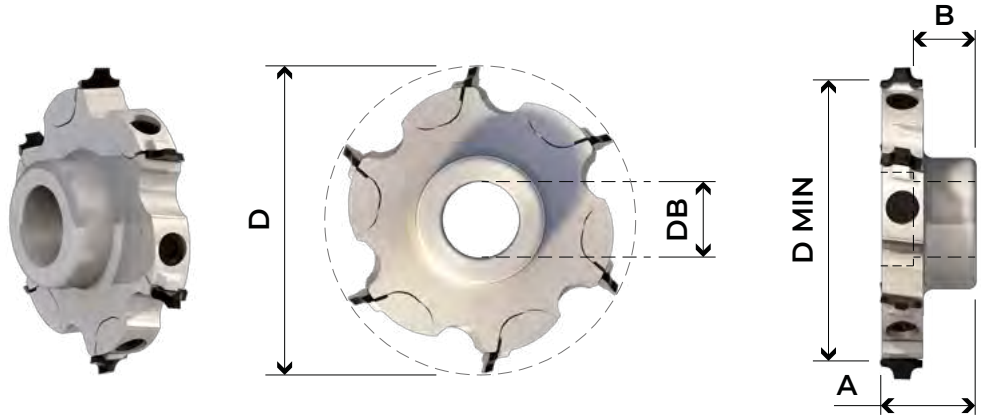

CORPO FRESA TOOL BODY

DIMENSIONI DIMENSIONS		MACCHINA MACHINE BRANDS				ARTICOLI ITEMS SX / LH CODICE / SKU DX / RH CODICE / SKU		PREZZI € PRICE €	
D DIAM.	Dmin MIN DIAM.	Z EFF ACTUAL TEETH	DB HOLE DIAM.	A THICK.	B THICK.				
75	70	4	HSK25R	23	15	HOMAG-IMA	FFS5018001	FFS5018002	
75	70	6	HSK25R	23	15	HOMAG-IMA	FFS5018003	FFS5018004	

INSERTO DI RICAMBIO SPARE KNIFE

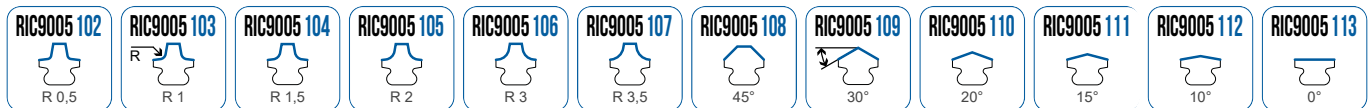

Inserto affilato solo su un lato / Spare knife sharpen only on one side.

INSERTO INSERT	PREZZO PRICE	ARTICOLO ITEM	PREZZO PRICE	ARTICOLO ITEM	PREZZO PRICE
INSERTO PROFILATO IN PCD PCD PROFILE INSERT RIC9005102-113		BLOCCO DI FISSAGGIO CLAMPING WEDGE RIC9006018		VITE CLAMPING SCREW RIC9006019	

FFS5009 SCM IDM

FRESE BORDATRICI
IN DIAMANTE PER RAGGIARE
MACCHINA SCM - IDM C1/C2
CON AIR SYSTEM

DIAMOND EDGE ROUNDING
CUTTERS FOR SCM - IDM
WITH AIR SYSTEM

Per raggiare bordi incollati di
legni massicci, legni teneri o duri
e materie plastiche su macchine
bordatrici SCM - IDM C1/C2 CON
AIR SYSTEM.

For rounding solid wood, veneer
and plastic edge bands for SCM -
IDM C1/C2 CON AIR SYSTEM.

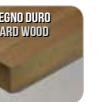
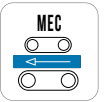
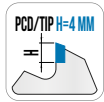
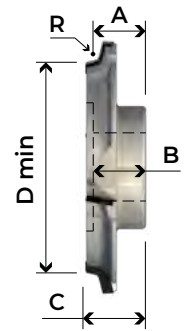
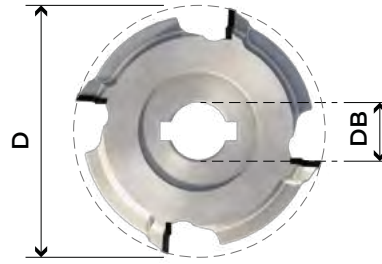

DIMENSIONI		DIMENSIONS		MACCHINA							ARTICOLI ITEMS		PREZZI €
D	Dmin	R	Z EFF	DB	DKN	H PCD	A	B	C	MACHINE BRANDS	SX / LH	DX / RH	PRICE €
DIAMETER	MIN DIAM.	RADIUS	ACTUAL TEETH	HOLE DIAM.		PCD HEIGHT	THICK.	THICK.	THICK.		CODICE / SKU	CODICE / SKU	
70	60	0,5	4	16	2	4	14	14	16	SCM - IDM	FFS5009001	FFS5009002	
70	60	1	4	16	2	4	14	14	16	SCM - IDM	FFS5009003	FFS5009004	
70	60	1,5	4	16	2	4	14	14	16	SCM - IDM	FFS5009005	FFS5009006	
70	60	2	4	16	2	4	14	14	16	SCM - IDM	FFS5009007	FFS5009008	
70	60	2,5	4	16	2	4	14	14	16	SCM - IDM	FFS5009009	FFS5009010	
70	60	3	4	16	2	4	14	14	16	SCM - IDM	FFS5009011	FFS5009012	

FFS5010 BIESSE

FRESA PER RAGGIARE Z6
MACCHINA BIESSE ERGHO
AKRON

DIAMOND EDGE Z6 ROUNDING
CUTTERS FOR BIESSE ERGHO
AKRON

Per raggiare bordi incollati di
legni massicci, legni teneri o duri
e materie plastiche su macchine
bordatrici BIESSE ERGHO
AKRON.

For rounding solid wood, veneer
and plastic edge bands for
BIESSE ERGHO AKRON.

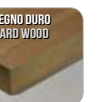
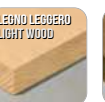
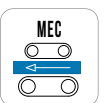
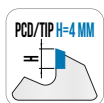
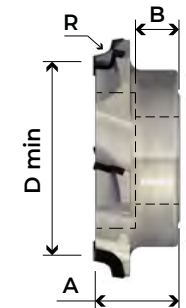
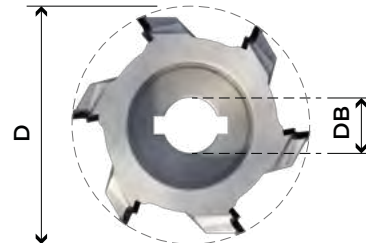

DIMENSIONI		DIMENSIONS		MACCHINA							ARTICOLI ITEMS		PREZZI €
D	Dmin	R	Z EFF	DB	DKN	H PCD	B	A		MACHINE BRANDS	SX / LH	DX / RH	PRICE €
DIAMETER	DIAMETER	RADIUS	ACTUAL TEETH	HOLE DIAM.		PCD HEIGHT	THICK.	THICK.			CODICE / SKU	CODICE / SKU	
68	60	0,5	6	16	2	4	11	22		BIESSE ERGHO AKRON	FFS5010001	FFS5010002	
68	60	1	6	16	2	4	11	22		BIESSE ERGHO AKRON	FFS5010003	FFS5010004	
68	60	1,5	6	16	2	4	11	22		BIESSE ERGHO AKRON	FFS5010005	FFS5010006	
68	60	2	6	16	2	4	11	22		BIESSE ERGHO AKRON	FFS5010007	FFS5010008	
68	60	2,5	6	16	2	4	11	22		BIESSE ERGHO AKRON	FFS5010009	FFS5010010	
68	60	3	6	16	2	4	11	22		BIESSE ERGHO AKRON	FFS5010011	FFS5010012	

FFS5011 BIESSE

FRESA PER RAGGIARE Z6
MACCHINA BIESSE

DIAMOND EDGE ROUNDING Z6
CUTTERS FOR BIESSE

Per raggiare bordi incollati di legni massicci, legni teneri o duri e materie plastiche su macchine bordatrici BIESSE.

For rounding solid wood, veneer and plastic edge bands for BIESSE.

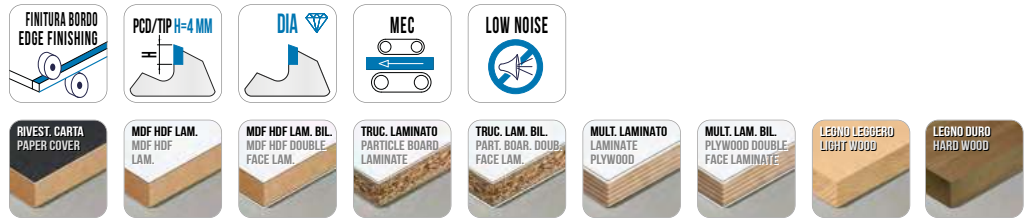
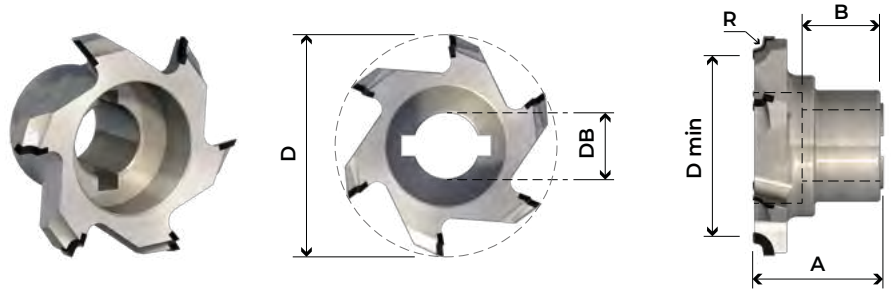

DIMENSIONI DIMENSIONS					MACCHINA				ARTICOLI ITEMS		PREZZI €
D	Dmin	R	Z EFF	DB	H PCD	B	A	MACHINE BRANDS	SX / LH	DX / RH	PRICE €
DIAMETER	DIAMETER	RADIUS	ACTUAL TEETH	HOLE DIAM.	PCD HEIGHT	THICK.	THICK.		CODICE / SKU	CODICE / SKU	
67	60	0,5	6	20	2	4	25,5	BIESSE	FFS5011001	FFS5011002	
67	60	1	6	20	2	4	25,5	BIESSE	FFS5011003	FFS5011004	
67	60	1,5	6	20	2	4	25,5	BIESSE	FFS5011005	FFS5011006	
68	60	2	6	20	2	4	25,5	BIESSE	FFS5011007	FFS5011008	
68	60	2,5	6	20	2	4	25,5	BIESSE	FFS5011009	FFS5011010	
70	60	3	6	20	2	4	25,5	BIESSE	FFS5011011	FFS5011012	

FFS5012 HOMAG IMA

FRESA PER RAGGIARE
MACCHINA HOMAG FF - IMA

DIAMOND EDGE ROUNDING
CUTTERS FOR HOMAG FF - IMA

Per raggiare bordi incollati di legni massicci, legni teneri o duri e materie plastiche su macchine bordatrici HOMAG FF - IMA.

For rounding solid wood, veneer and plastic edge bands for HOMAG FF - IMA.

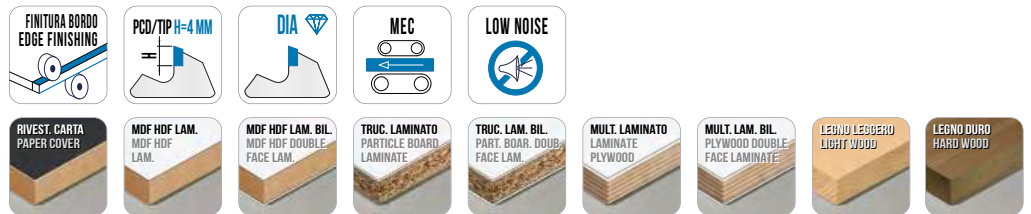
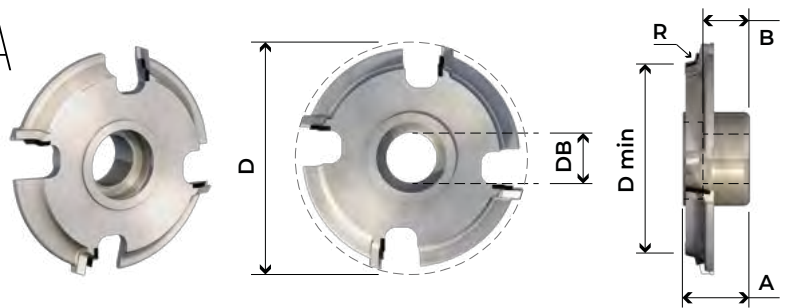

DIMENSIONI DIMENSIONS					MACCHINA				ARTICOLI ITEMS		PREZZI €
D	Dmin	R	Z EFF	DB	H PCD	B	A	MACHINE BRANDS	SX / LH	DX / RH	PRICE €
DIAMETER	DIAMETER	RADIUS	ACTUAL TEETH	HOLE DIAM.	PCD HEIGHT	THICKNESS	THICKNESS		CODICE / SKU	CODICE / SKU	
84	70	0,5	4	HSK25R	4	15	23	HOMAG - IMA	FFS5012001	FFS5012002	
84	70	1	4	HSK25R	4	15	23	HOMAG - IMA	FFS5012003	FFS5012004	
84	70	1,5	4	HSK25R	4	15	23	HOMAG - IMA	FFS5012005	FFS5012006	
84	70	2	4	HSK25R	4	15	23	HOMAG - IMA	FFS5012007	FFS5012008	
84	70	2,5	4	HSK25R	4	15	23	HOMAG - IMA	FFS5012009	FFS5012010	
84	70	3	4	HSK25R	4	15	23	HOMAG - IMA	FFS5012011	FFS5012012	
84	70	0,5	6	HSK25R	4	15	23	HOMAG - IMA	FFS5012013	FFS5012014	
84	70	1	6	HSK25R	4	15	23	HOMAG - IMA	FFS5012015	FFS5012016	
84	70	1,5	6	HSK25R	4	15	23	HOMAG - IMA	FFS5012017	FFS5012018	
84	70	2	6	HSK25R	4	15	23	HOMAG - IMA	FFS5012019	FFS5012020	
84	70	2,5	6	HSK25R	4	15	23	HOMAG - IMA	FFS5012021	FFS5012022	
84	70	3	6	HSK25R	4	15	23	HOMAG - IMA	FFS5012023	FFS5012024	

RICAMBI PARTS			
DESCRIZIONE	DIMENSIONI	ARTICOLI	PREZZO
DESCRIPTION	DIMENSIONS	ITEMS	PRICE
VITE PER HSK25 - INSERT SCREW FOR HSK25	M10X20X35	RIC9007059	
SEGER PER HSK25	25,8X1,2	RIC9014008	
ANELLO PER HSK25	SPESSORE - THICKNESS 24,7X18X1	RIC9009015	

FFS50 13 HOMAG IMA

FRESA PER SMUSSARE HSK32
MACCHINA HOMAG

DIAMOND EDGE CHAMFERING
CUTTERS FOR HOMAG

Per smussare bordi incollati di legni massicci, legni teneri o duri e materie plastiche su macchine bordatrici HOMAG.

For chamfering solid wood, veneer and plastic edge bands for HOMAG.

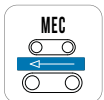
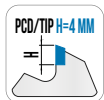
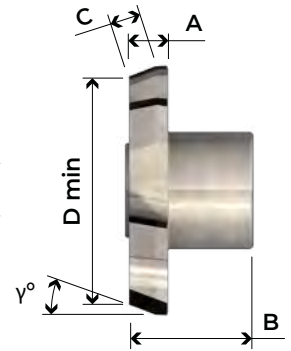
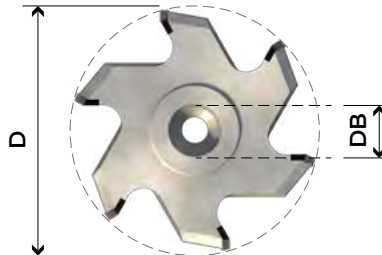

DIMENSIONI		DIMENSIONS			MACCHINA					ARTICOLI ITEMS		PREZZI €
D	Dmin	γ°	Z EFF	DB	H PCD	A	B	C	MACHINE BRANDS	SX / LH	DX / RH	PRICE €
DIAMETER	DIAMETER	Range	ACTUAL TEETH	HOLE DIAM.	PCD HEIGHT	THICK.	THICK.	THICK.		CODICE / SKU	CODICE / SKU	
63,4	62	5	4	HSK32	4	10	34	8	HOMAG - IMA	FFS5013001	FFS5013002	
64,8	62	10	4	HSK32	4	10	34	8	HOMAG - IMA	FFS5013003	FFS5013004	
67,5	62	20	4	HSK32	4	10	34	8	HOMAG - IMA	FFS5013005	FFS5013006	
70	62	30	4	HSK32	4	10	34	8	HOMAG - IMA	FFS5013007	FFS5013008	
73,3	62	45	4	HSK32	4	10	34	8	HOMAG - IMA	FFS5013009	FFS5013010	
63,4	62	5	6	HSK32	4	10	34	8	HOMAG - IMA	FFS5013011	FFS5013012	
64,8	62	10	6	HSK32	4	10	34	8	HOMAG - IMA	FFS5013013	FFS5013014	
67,5	62	20	6	HSK32	4	10	34	8	HOMAG - IMA	FFS5013015	FFS5013016	
70	62	30	6	HSK32	4	10	34	8	HOMAG - IMA	FFS5013017	FFS5013018	
73,3	62	45	6	HSK32	4	10	34	8	HOMAG - IMA	FFS5013019	FFS5013020	
63,4	62	5	8	HSK32	4	10	34	8	HOMAG - IMA	FFS5013021	FFS5013022	
64,8	62	10	8	HSK32	4	10	34	8	HOMAG - IMA	FFS5013023	FFS5013024	
67,5	62	20	8	HSK32	4	10	34	8	HOMAG - IMA	FFS5013025	FFS5013026	
70	62	30	8	HSK32	4	10	34	8	HOMAG - IMA	FFS5013027	FFS5013028	
73,3	62	45	8	HSK32	4	10	34	8	HOMAG - IMA	FFS5013029	FFS5013030	

RICAMBI PARTS			
DESCRIZIONE	DIMENSIONI	ARTICOLI	PREZZO
DESCRIPTION	DIMENSIONS	ITEMS	PRICE
VITE PER HSK32 - INSERT SCREW FOR HSK32	M6X35X40	RIC9007058	
SEGER PER HSK32	16X1	RIC9014007	
ANELLO PER HSK32	SPESSORE - THICKNESS 13,8X8X1	RIC9009016	

FFS50 14

FRESA PER RAGGIARE HSK32
MACCHINA HOMAG

DIAMOND EDGE ROUNDING
CUTTERS FOR HOMAG

Per raggiare bordi incollati di legni massicci, legni teneri o duri e materie plastiche su macchine bordatrici HOMAG.

For rounding solid wood, veneer and plastic edge bands for HOMAG.

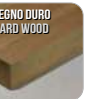
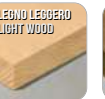
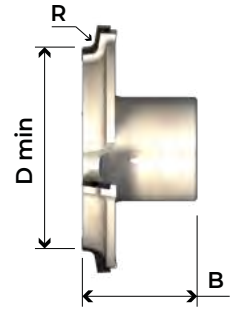
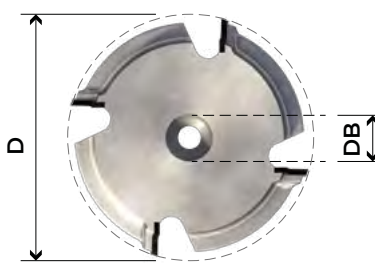

DIMENSIONI DIMENSIONS				MACCHINA			ARTICOLI ITEMS		PREZZI €	
Dmin DIAMETER	D DIAMETER	R RADIUS	Z EFF ACTUAL TEETH	DB HOLE DIAM.	H PCD PCD HEIGHT	B THICKNESS	MACHINE BRANDS	SX / LH CODICE / SKU	DX / RH CODICE / SKU	PRICE €
62	74	0,5	4	HSK32R	4	34	HOMAG	FFS5014001	FFS5014002	
62	74	1	4	HSK25R	4	34	HOMAG	FFS5014003	FFS5014004	
62	74	1,5	4	HSK25R	4	34	HOMAG	FFS5014005	FFS5014006	
62	74	2	4	HSK25R	4	34	HOMAG	FFS5014007	FFS5014008	
62	74	1,5	4	HSK25R	4	34	HOMAG	FFS5014009	FFS5014010	
62	74	3	4	HSK25R	4	34	HOMAG	FFS5014011	FFS5014012	
62	74	3,5	4	HSK25R	4	34	HOMAG	FFS5014013	FFS5014014	
62	74	4	4	HSK25R	4	34	HOMAG	FFS5014015	FFS5014016	
62	74	5	4	HSK25R	4	34	HOMAG	FFS5014017	FFS5014018	
62	74	0,5	6	HSK32R	4	34	HOMAG	FFS5014019	FFS5014020	
62	74	1	6	HSK25R	4	34	HOMAG	FFS5014021	FFS5014022	
62	74	1,5	6	HSK25R	4	34	HOMAG	FFS5014023	FFS5014024	
62	74	2	6	HSK25R	4	34	HOMAG	FFS5014025	FFS5014026	
62	74	1,5	6	HSK25R	4	34	HOMAG	FFS5014027	FFS5014028	
62	74	3	6	HSK25R	4	34	HOMAG	FFS5014029	FFS5014030	
62	74	3,5	6	HSK25R	4	34	HOMAG	FFS5014031	FFS5014032	
62	74	4	6	HSK25R	4	34	HOMAG	FFS5014033	FFS5014034	
62	74	5	6	HSK25R	4	34	HOMAG	FFS5014035	FFS5014036	
62	74	0,5	8	HSK32R	4	34	HOMAG	FFS5014037	FFS5014038	
62	74	1	8	HSK25R	4	34	HOMAG	FFS5014039	FFS5014040	
62	74	1,5	8	HSK25R	4	34	HOMAG	FFS5014041	FFS5014042	
62	74	2	8	HSK25R	4	34	HOMAG	FFS5014043	FFS5014044	
62	74	1,5	8	HSK25R	4	34	HOMAG	FFS5014045	FFS5014046	
62	74	3	8	HSK25R	4	34	HOMAG	FFS5014047	FFS5014048	
62	74	3,5	8	HSK25R	4	34	HOMAG	FFS5014049	FFS5014050	
62	74	4	8	HSK25R	4	34	HOMAG	FFS5014051	FFS5014052	
62	74	5	8	HSK25R	4	34	HOMAG	FFS5014053	FFS5014054	

RICAMBI PARTS			
DESCRIZIONE DESCRIPTION	DIMENSIONI DIMENSIONS	ARTICOLI ITEMS	PREZZO PRICE
VITE PER HSK32 - INSERT SCREW FOR HSK32	M6X35X40	RIC9007058	
SEGER PER HSK32	16X1	RIC9014007	
ANELLO PER HSK32	SPESSORE - THICKNESS 13,8X8X1	RIC9009016	

JOINT CUT 2 FFS5016

NEW

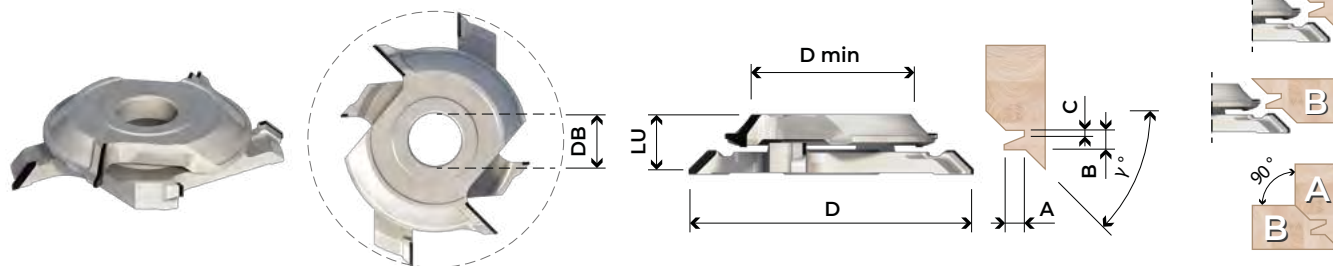

FRESA REGOLABILE PER GIUNZIONI CON FORO
AJUSTABLE CUTTER FOR JOINTING

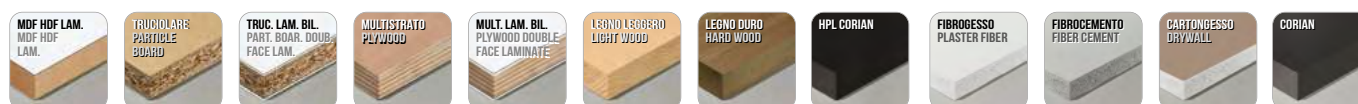

DIMENSIONI DIMENSIONS											ARTICOLI ITEMS		PREZZI €	
D	Dmin	Z EFF	LU	DB	DKN	H PCD	β°	A	B	C	γ°	SX / LH	DX / RH	PRICE €
DIAMETER	DIAMETER	A. TEETH	U. LENGHT	HOLE DIAM.		PCD HEIGHT	AXIAL ANGLE	THICK.	THICK.	THICK.	AXIAL ANGLE	CODICE / SKU	CODICE / SKU	
170	106	2	32	30	2	4,5	0°	10	10	3	45°	FFS5016001	FFS5016002	
170	106	2	32	35	2	4,5	0°	10	10	3	45°	FFS5016003	FFS5016004	
170	106	2	32	40	2	4,5	0°	10	10	3	45°	FFS5016005	FFS5016006	
170	106	3	32	30	2	4,5	0°	10	10	3	45°	FFS5016007	FFS5016008	
170	106	3	32	35	2	4,5	0°	10	10	3	45°	FFS5016009	FFS5016010	
170	106	3	32	40	2	4,5	0°	10	10	3	45°	FFS5016011	FFS5016012	
170	80	2	45	30	2	4,5	0°	10	10	3	45°	FFS5016013	FFS5016014	
170	80	2	45	35	2	4,5	0°	10	10	3	45°	FFS5016015	FFS5016016	
170	80	2	45	40	2	4,5	0°	10	10	3	45°	FFS5016017	FFS5016018	
170	80	3	45	30	2	4,5	0°	10	10	3	45°	FFS5016019	FFS5016020	
170	80	3	45	35	2	4,5	0°	10	10	3	45°	FFS5016021	FFS5016022	
170	80	3	45	40	2	4,5	0°	10	10	3	45°	FFS5016023	FFS5016024	

FFS5017

NEW

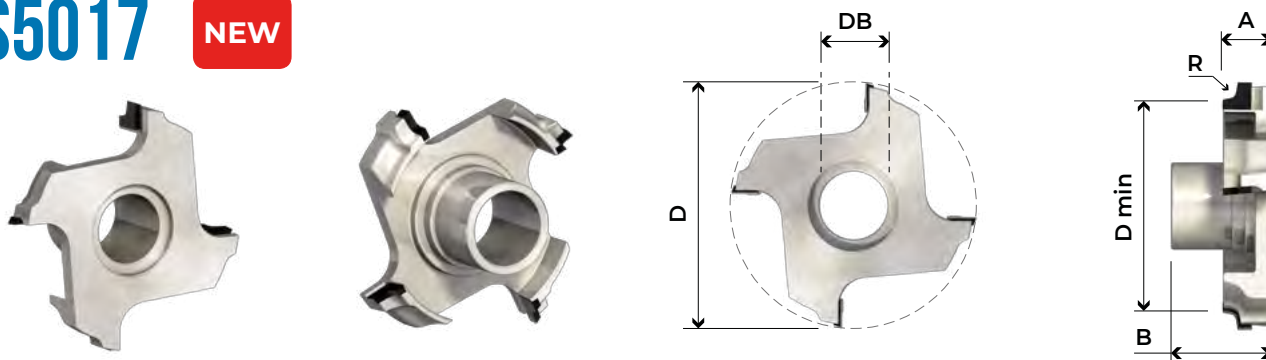

FRESA RAGGIATRICE Z4 CON COPIATORE
PCD RADIUS CUTTER WITH COPIER

Fresa bordatrice in diamante per raggiare utilizzabile su macchine con copiatore.
PCD radius cutter with copier to be used on edgebander.



DIMENSIONI DIMENSIONS										ARTICOLI ITEMS		PREZZI €
D	Dmin	R	Z EFF	DB	H PCD	A	B	SX / LH	DX / RH	PRICE €		
DIAMETER	DIAMETER	RADIUS	A. TEETH	HOLE DIAM.	PCD HEIGHT	THICKNESS	THICKNESS	CODICE / SKU	CODICE / SKU			
57,5	50	0,5	4	16	4	11,5	23,5	FFS5017001	FFS5017002			
57,5	50	1	4	16	4	11,5	23,5	FFS5017003	FFS5017004			
57,5	50	1,5	4	16	4	11,5	23,5	FFS5017005	FFS5017006			
58	50	2	4	16	4	11,5	23,5	FFS5017007	FFS5017008			
58	50	2,5	4	16	4	11,5	23,5	FFS5017009	FFS5017010			
58	50	3	4	16	4	11,5	23,5	FFS5017011	FFS5017012			

V CUT 8 FFS5015

NEW

FRESA CON FORO PER
SMUSSARE PANNELLI A
45° CON ANGOLO ASSIALE
POSITIVO NEGATIVO

HOLE CUTTER WITH HOLE FOR
CUTTING PANELS AT 45° WITH
POSITIVE NEGATIVE AXIAL
ANGLE

Fresa con foro per smussare pannelli a 45° con angolo assiale positivo negativo per ottime finiture superficiali. Da montare su toupie, macchine bordatrici o squadratrici.

Cutter with hole for chamfering panels at 45° with positive negative axial angle for excellent surface finishes. To be applied on spindle moulders, edge banding or squaring machines.

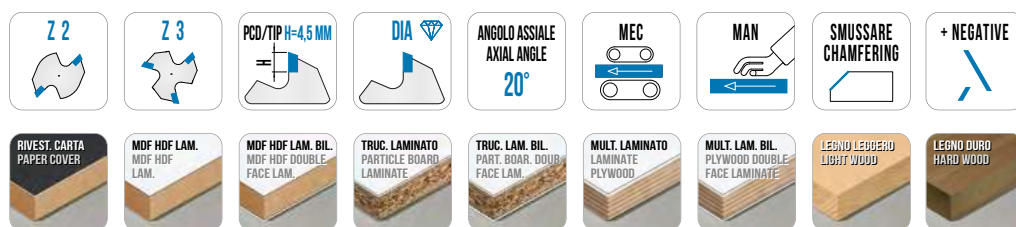
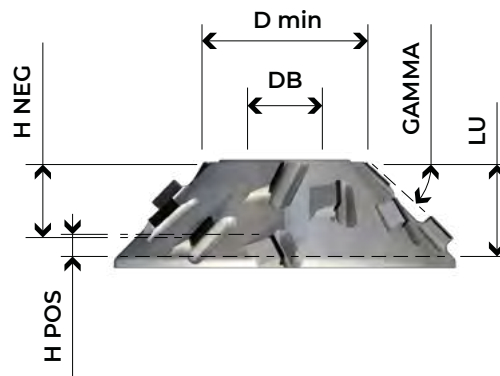
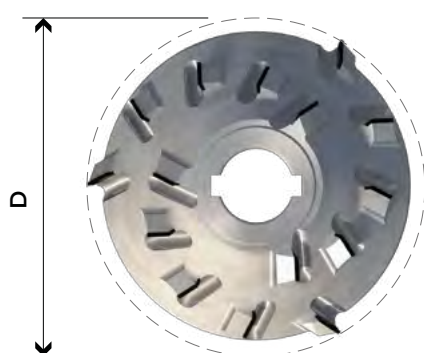

ARTICOLI ITEMS											PREZZI €	
D	Dmin	LU	Z EFF	DB	DKN	H PCD	GAMMA	Z TOT	BETA	SX / LH	DX / RH	PRICE €
DIAMETER	DIAMETER	U. LENGHT	ACTUAL TEETH	HOLE DIAM.		PCD HEIGHT		TOT. TEETH		CODICE / SKU	CODICE / SKU	
160	96	32	2	30	2	4,5	45°	8	20°	FFS5015001	FFS5015002	
160	96	32	2	35	2	4,5	45°	8	20°	FFS5015003	FFS5015004	
160	96	32	2	40	2	4,5	45°	8	20°	FFS5015005	FFS5015006	
160	96	32	3	30	2	4,5	45°	12	20°	FFS5015007	FFS5015008	
160	96	32	3	35	2	4,5	45°	12	20°	FFS5015009	FFS5015010	
160	96	32	3	40	2	4,5	45°	12	20°	FFS5015011	FFS5015012	
160	80	40	2	30	2	4,5	45°	10	20°	FFS5015013	FFS5015014	
160	80	40	2	35	2	4,5	45°	10	20°	FFS5015015	FFS5015016	
160	80	40	2	40	2	4,5	45°	10	20°	FFS5015017	FFS5015018	
160	80	40	3	30	2	4,5	45°	15	20°	FFS5015019	FFS5015020	
160	80	40	3	35	2	4,5	45°	15	20°	FFS5015021	FFS5015022	
160	80	40	3	40	2	4,5	45°	15	20°	FFS5015023	FFS5015024	



FRESE PANTOGRAFO DRITTE

STRAIGHT SHANK CUTTERS



FULLCUT 1 EC1H FPD2001

FRESA DIAMANTE TAGLIENTE
DRITTO Z1 CON CORPO HW
PCD SHANK CUTTER STRAIGHT
CUT Z1 HW BODY

94
PAG.



FULLCUT 4 EC2HN FPD2006

FRESA DIAMANTE TAGLIENTE
NEGATIVO Z2 CON CORPO HW
PCD SHANK CUTTER NEGATIVE
CUT Z2 HW BODY

95
PAG.



FULLCUT 2 EC1HN FPD2003

FRESA DIAMANTE TAGLIENTE
NEGATIVO Z1 CON CORPO HW
PCD SHANK CUTTER NEGATIVE
CUT Z1 HW BODY

94
PAG.



FULLCUT 5 EC2A FPD2009

FRESA DIAMANTE TAGLIENTE
DRITTO Z2 CORPO IN ACCIAIO
PCD SHANK CUTTER STRAIGHT
CUT Z2 STEEL BODY

96
PAG.



FULLCUT 3 EC2H FPD2004

FRESA DIAMANTE TAGLIENTE
DRITTO Z2 CON CORPO HW
PCD SHANK CUTTER STRAIGHT
CUT Z2 HW BODY

95
PAG.



FULLCUT 6 EC2AN FPD2010

FRESA DIAMANTE TAGLIENTE
NEG. Z2 CORPO IN ACCIAIO
PCD SHANK CUTTER negative
CUT Z2 STEEL BODY

97
PAG.



FULLCUT 7 EC2HPN FPD2046

FRESA PER RIFILARE
IN DIAMANTE

DIA ROUTER BIT
WITH COPYNG BEARING

98
PAG.



ECOCUT PLUS 2 RC4 FPD2016

FRESA ELICOIDALE IN DIAMANTE
Z2+2 CORPO IN ACCIAIO PCD H4,5 MM

PCD HELICOIDAL SHANK CUTTER
Z2+2 STEEL BODY PCD H4,5 MM

103
PAG.



REFILCUT 1 RIFILATORE FPD2055

FRESA PER RIFILARE
IN DIAMANTE

DIA ROUTER BIT
WITH COPYNG BEARING

98
PAG.



ECOCUT 8 EC4S FPD2017

FRESA ELICOIDALE IN DIAMANTE Z1+1
/2+2 CORPO IN ACCIAIO PCD H2,5 MM

PCD HELICOIDAL SHANK CUTTER
Z1+1 /2+2 STEEL BODY PCD H 2,5 MM

104
PAG.



POWERCUT 2 FPD2038

FRESA DIAMANTE TAGLIENTE ALTER.
POS / NEG Z4 ROMPIRUCIOLO CORPO
METALLO PESANTE

PCD SHANK CUTTER WITH ALTERNATE
CUT POS./NEG. Z4 HDM BODY WITH
ROUGH/FINISCHING CUTTING TIPS

99
PAG.



REFILCUT 2 EC3EB FPD2014

FRESA ELICOIDALE IN DIAMANTE CON
CUSCINETTO Z1+1 CORPO IN ACCIAIO
PCD H2,5 MM

PCD HELICOIDAL SHANK CUTTER Z1+1
WITH COPY BEARING STEEL BODY
PCD H2,5 MM

104
PAG.



POWERCUT 3 FPD2039

FRESA DIAMANTE TAGLIENTE ALTER.
CORPO METALLO PESANTE

PCD SHANK CUTTER WITH ALTERNATE
CUT POS./NEG. Z4 HDM BODY WITH
ROUGH/FINISCHING CUTTING TIPS

99
PAG.



ECX3 FPD2020

FRESA ELICOIDALE IN DIAMANTE
Z2+2 CORPO IN ACCIAIO PCD H2,5 MM

PCD HELICOIDAL SHANK CUTTER
Z2+2 STEEL BODY PCD H2,5 MM

105
PAG.



ECOCUT 1 EC2E FPD2011

FRESA ELICOIDALE
IN DIAMANTE Z1+1 PCD H2,5 MM

PCD HELICOIDAL SHANK
UTTER Z1+1 PCD H2,5 MM

100
PAG.



RX3 FPD2021

FRESA ELICOIDALE IN DIAMANTE
Z2+2 CORPO IN ACCIAIO PCD H4,5 MM

PCD HELICOIDAL SHANK CUTTER
Z2+2 STEEL BODY PCD H4,5 MM

105
PAG.



ECOCUT 2 EC2EH HDM FPD2053

FRESA ELICOIDALE
IN DIAMANTE Z1+1 PCD H2,5 MM

PCD HELICOIDAL SHANK
CUTTER Z1+1 PCD H2,5 MM

100
PAG.



ULTRACUT 1 UL FPD2024

FRESA ELICOIDALE IN DIAMANTE Z3+3
CORPO IN ACCIAIO PCD H4,5 MM

PCD HELICOIDAL SHANK CUTTER
Z3+3 STEEL BODY PCD H4,5 MM

106
PAG.



ECOCUT 3 EC3E FPD2012

FRESA ELICOIDALE IN DIAMANTE Z1+1
CORPO IN ACCIAIO PCD H2,5 MM

PCD HELICOIDAL SHANK CUTTER
Z1+1 STEEL BODY PCD H2,5 MM

101
PAG.



ULTRACUT 2 ULC FPD2025

FRESA ELICOIDALE IN DIAMANTE Z3+3
CORPO IN ACCIAIO PCD H4,5 MM

PCD HELICOIDAL SHANK CUTTER
Z3+3 STEEL BODY PCD H4,5 MM

106
PAG.



ECOCUT PLUS 1 RC3 FPD2013

FRESA ELICOIDALE IN DIAMANTE Z1+1
CORPO IN ACCIAIO PCD H4,5 MM

PCD HELICOIDAL SHANK CUTTER
Z1+1 STEEL BODY PCD H4,5 MM

101
PAG.



STARCUT 1 RX4 FPD2028

FRESA ELICOIDALE IN DIAMANTE Z2+2
ASSIALE 30° CORPO IN ACCIAIO
PCD H4,5 MM

PCD HELICOIDAL SHANK CUTTER
Z2+2 CUTTING ANGLE 30°
STEEL BODY PCD H4,5 MM

107
PAG.



ECOCUT 5 EC3H FPD2045

FRESA ELICOIDALE IN DIAMANTE Z1+1
CORPO IN ACCIAIO PCD H4,5 MM

PCD HELICOIDAL SHANK CUTTER
Z1+1 STEEL BODY PCD H4,5 MM

102
PAG.



STARCUT 2 RX4 FPD2057

FRESA ELICOIDALE DIA Z2+2 ASSIALE
30° CORPO IN ACCIAIO PCD H4,5
CON PRIMO PCD POSITIVO DI 5 MM

PCD HELICOIDAL SHANK CUTTER Z2+2
CUTTING ANGLE 30° STEEL BODY PCD
H4,5 MM FIRST PCD TIP POSITIVE 5 MM

108
PAG.



ECOCUT 6 EC4E FPD2015

RESA ELICOIDALE IN DIAMANTE
Z2+2 CORPO IN ACCIAIO PCD H2,5 MM

PCD HELICOIDAL SHANK CUTTER
Z2+2 STEEL BODY PCD H2,5 MM

102
PAG.



STARCUT 3 RX4C FPD2029

FRESA ELICOIDALE IN DIAMANTE
Z2+2 ASSIALE 30° CORPO IN ACCIAIO
PCD H4,5 MM

PCD HELICOIDAL SHANK CUTTER
Z2+2 CUTTING ANGLE 30° STEEL BODY
PCD H4,5 MM

108
PAG.



STARCUT 4 RX4S FPD2033

FRESA ELICOIDALE IN DIAMANTE Z2+2
ASSIALE 45° CORPO IN ACCIAIO
PCD H4,5 MM
PCD HELICOIDAL SHANK CUTTER Z2+2
CUTTING ANGLE 45° STEEL BODY
PCD H4,5 MM

109
PAG.



POWERCUT 8N FPD2059

FRESA NESTING ELICOIDALE
IN DIAMANTE Z2+2
CORPO IN METALLO PESANTE
PCD HELICOIDAL SHANK CUTTER
FOR NESTING Z2+2
HDM BODY

116
PAG.



STARCUT 5 RX4SC FPD2034

FRESA ELICOIDALE IN DIAMANTE
Z2+2 ASSIALE 45° CORPO IN ACCIAIO
PCD H4,5 MM
PCD HELICOIDAL SHANK CUTTER
Z2+2 CUTTING ANGLE 45° STEEL BODY
PCD H4,5 MM

110
PAG.



POWERCUT 6N FPD2043

FRESA NESTING ELICOIDALE
IN DIAMANTE Z3+3 CORPO IN HDM
PREVALENTEMENTE NEGATIVA
PCD HELICOIDAL SHANK CUTTER FOR
NESTING Z3+3 HDM BODY
PCD H3,5 MM, MAINLY NEGATIVE

117
PAG.



STARCUT 8 FPD2064

NEW

FRESA ELICOIDALE IN DIAMANTE
ROMPIRUCIOLO Z2+2 ASSIALE 30°
CORPO IN METALLO PESANTE PCD H4,5
PCD HELICOIDAL CHIP BREAKER
SHANK CUTTER Z2+2 AXIAL 30° HDM
BODY

111
PAG.



STARCUT 6 RX4B FPD2048

FRESA ELICOIDALE DOPPIA
ROTAZIONE IN DIAMANTE Z2+2

PCD HELICOIDAL SHANK CUTTERS
Z2+2 DOUBLE ROTATION

118
PAG.



EXTREME 1 REX2 FPD2036

FRESA ELICOIDALE IN DIAMANTE Z2+2
ASSIALE 54,9° CORPO IN ACCIAIO
PCD H4,5 MM
PCD HELICOIDAL SHANK CUTTER Z2+2
CUTTING ANGLE 54,9° STEEL BODY
PCD H4,5 MM

112
PAG.



ULTRACUT 3 ULB FPD2049

FRESA ELICOIDALE DOPPIA
ROTAZIONE IN DIAMANTE Z3+3

PCD HELICOIDAL SHANK CUTTERS
Z3+3 DOUBLE ROTATION

118
PAG.



AIRCUT 1 RX6 FPD2030

FRESA ELICOIDALE IN DIAMANTE
Z3+3 ASSIALE 30° CORPO IN ACCIAIO
PCD H4,5 MM
PCD HELICOIDAL SHANK CUTTER
Z3+3 CUTTING ANGLE 30° STEEL BODY
PCD H4,5 MM

113
PAG.



STARCUT 7 TRPE FPD2050

FRESA DA RETTIFICA ELICOIDALE
IN DIAMANTE Z4+4 ASSIALE 40°

PCD RECTIFYING SHANK CUTTERS
Z4+4 CUTTING ANGLE 40°

119
PAG.



POWERCUT 5 FPD2040

FRESA ELICOIDALE IN DIAMANTE
Z2+2 ASSIALE 25° CORPO IN METALLO
PESANTE PCD H3,5 MM
PCD HELICOIDAL SHANK CUTTER Z2+2
CUTTING ANGLE 25° HDM BODY
PCD H3,5 MM

114
PAG.



EXTREME 2 TRPX FPD2060

FRESA DA RETTIFICA ELICOIDALE
IN DIAMANTE Z3+3 ASSIALE 54,9°

PCD RECTIFY SHANK CUTTERS
Z3+3 CUTTING ANGLE 54,9°

120
PAG.



POWERCUT 5A FPD2054

FRESA ELICOIDALE IN DIAMANTE Z2+2
ASSIALE 25° CORPO IN ACCIAIO
PCD H3,5 MM
PCD HELICOIDAL SHANK CUTTER Z2+2
CUTTING ANGLE 25° STEEL BODY
PCD H3,5 MM

114
PAG.



STARCUT 9 FPD2063

NEW

FRESA DA RETTIFICA ELICOIDALE
IN DIAMANTE PREVALENTEMENTE
NEGATIVA CON TAGLIANTE IN TESTA
PCD HELICOIDAL SHANK CUTTER
MAINLY NEGATIVE AND TIP AT THE
BOTTOM

121
PAG.



POWERCUT 4N FPD2041

FRESA NESTING ELICOIDALE
IN DIAMANTE Z3+3
CORPO IN METALLO PESANTE
PCD HELICOIDAL SHANK CUTTER
FOR NESTING Z3+3
HDM BODY

115
PAG.



SPACE 1 HW FPD2517

FRESA A COLTELLINI PER SPIANARE
E PER BATTUTE A COLTELLINI

INSERT KNIFE SHANK CUTTER
FOR PLANNING PANEL

122
PAG.



POWERCUT 4NA FPD2058

FRESA NESTING ELICOIDALE
IN DIAMANTE Z3+3
CORPO IN ACCIAIO
PCD HELICOIDAL SHANK CUTTER
FOR NESTING Z3+3
STEEL BODY

115
PAG.



SPACE 2 FPD2056

FRESA IN DIAMANTE PER
SPIANARE E PER BATTUTE

DIA FLY CUTTER

123
PAG.



POWERCUT 4P FPD2042

FRESA NESTING ELICOIDALE
IN DIAMANTE Z3+3
CORPO IN METALLO PESANTE
PCD HELICOIDAL SHANK CUTTER
FOR NESTING Z3+3 PCD H3,5 mm
HDM BODY

116
PAG.























SPACE 3 FPD2061

FRESA IN DIAMANTE
PER SPIANARE,
FORARE E PER BATTUTE

DIA FLY CUTTER

123
PAG.

	AVANTECH 1 FPD2052 FRESA IN DIAMANTE Z2+2 PER CAVE SERRATURE DI PORTE CORPO IN METALLO PESANTE PCD HELICOIDAL SHANK CUTTERS Z2+2 FOR MACHINING DOOR LOCKS, HDM (HIGH DENSITY METAL) BODY	124 PAG.
	AVANTECH 2 FPD2518 FRESA ELICOIDALE PER CAVE SERRATURE DI PORTE IN HW POSITIVA ROMPITRUCIOLO Z3 CON PARTE NEGATIVA DI FINITURA PER LAVORAZIONE PIASTRINA HW POSITIVE SHANK CUTTER TO WORK DOOR LOCK SLOT-CHIP BREAKER Z3 WITH NEGATIVE PART FOR BETTER FINISHING OF PLATE HOUSE	134 PAG.
	AVANTECH 3 FPD2062 NEW FRESA IN DIAMANTE Z2+2 PER CAVE SERRATURE DI PORTE CORPO IN DENSIMET PCD HELICOIDAL SHANK CUTTERS Z2+2 FOR MACHINING DOOR LOCKS HDM (HIGH DENSITY METAL) BODY	125 PAG.
	RAPTOR 2 FPD2508 FRESA ELICOIDALI IN HW NEGATIVA Z3 CON ROMPITRUCIOLO HW MILLING CUTTERS Z3 POSITIVE	135 PAG.
	FINISH 1 FPD2501 FRESA ELICOIDALE IN HW POSITIVA Z1 HW MILLING CUTTERS Z1 POSITIVE	126 PAG.
	FINISH 7 FPD2509 FRESE ELICOIDALI IN HW POSITIVA Z3 PER CAVE SERRATURE DI PORTE HW MILLING CUTTERS Z3 POSITIVE FOR MACHINING DOOR LOCKS	136 PAG.
	FINISH 2 FPD2502 FRESA ELICOIDALE IN HW NEGATIVA Z1 HW MILLING CUTTERS Z1 NEGATIVE	127 PAG.
	RAPTOR 3 FPD2510 FRESA ELICOIDALE IN HW POSITIVA Z3 CON ROMPITRUCIOLO PER CAVE SERRATURE DI PORTE HW MILLING CUTTERS FOR MACHINING DOOR LOCKS FOR ROUGHING Z3 POSITIVE	136 PAG.
	FINISH 3 FPD2503 FRESA ELICOIDALE IN HW POSITIVA Z2 HW MILLING CUTTERS Z2 POSITIVE	128 PAG.
	FINISH 8 FPD2511 FRESE ELICOIDALI IN HW NEGATIVA Z3 PER CAVE SERRATURE DI PORTE HW MILLING CUTTERS Z3 NEGATIVE FOR MACHINING DOOR LOCKS	137 PAG.
	FINISH 4 FPD2504 FRESA ELICOIDALI IN HW NEGATIVA Z2 HW MILLING CUTTERS Z2 NEGATIVE	129 PAG.
	RAPTOR 4 FPD2512 FRESA ELICOIDALE IN HW NEGATIVA Z3 CON ROMPITRUCIOLO PER CAVE SERRATURE DI PORTE HW MILLING CUTTERS FOR MACHINING DOOR LOCKS FOR ROUGHING Z3 NEGATIVE	137 PAG.
	FINISH 5 FPD2505 FRESA ELICOIDALI IN HW POSITIVA Z3 HW MILLING CUTTERS Z3 POSITIVE	130 PAG.
	FINISH 9 FPD2514 FRESA ELICOIDALE IN HW UP-DOWN POSITIVA / NEGATIVA Z2+2 HW DOUBLE ACTION MILLING CUTTERS Z2+2 POSITIVE / NEGATIVE	138 PAG.
	RAPTOR 1 FPD2506 FRESA ELICOIDALI IN HW POSITIVA Z3 CON ROMPITRUCIOLO HW MILLING CUTTERS Z3 POSITIVE	131 PAG.
	POWERCUT 7W FPD2516 FRESA ELICOIDALE PER NESTING IN HW RIVESTITA UP-DOWN POSITIVA/NEGATIVA Z2+2 HW DOUBLE ACTION MILLING CUTTERS FOR HIGH SPEED NESTING Z2+2 POSITIVE/NEGATIVE	139 PAG.
	FINISH 6 FPD2507 FRESA ELICOIDALE IN HW NEGATIVA Z3 HW MILLING CUTTERS Z3 NEGATIVE	132 PAG.
	FINISH 11 FPD2519 NEW FRESA ELICOIDALE IN HW POSITIVA Z2 SFERICA DI FINITURA HELICOIDAL HW SHANK CUTTER Z2 SPHERICAL FINISHING	140 PAG.
	AVANTECH 4 FPD2521 NEW FRESA A COLTELLINI PER SCASSI SERRATUREPORTE CORPO HDM HEAVY STEEL CUTTER FOR LOCK-SET	133 PAG.
	FINISH 12 FPD2520 NEW FRESA ELICOIDALE IN HW POSITIVA Z3 CON ROMPITRUCIOLO DI FINITURA HELICOIDAL HW SHANK CUTTER Z3 POSITIVE WITH FINISHING CHIPS BREAKERS	141 PAG.

FULLCUT 1 EC1H

FPD2001

FRESA DIAMANTE TAGLIANTE DRITTO Z1 CON CORPO HW
PCD SHANK CUTTER STRAIGHT CUT Z1 HW BODY

Fresa in diamante con tagliente dritto Z1, corpo fresa in HW integrale. Ottima per lavorazione di pannelli in truciolare, MDF, multistrato, legni senza nodi e materiali polimerici.

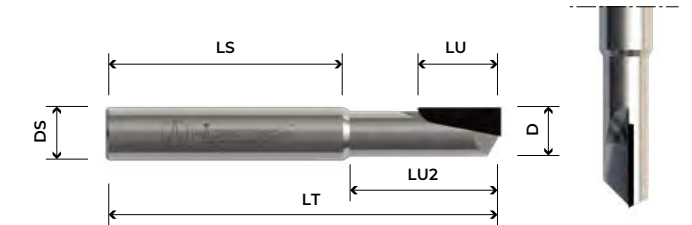

PCD shank cutter with straight cut Z1 carbide body. Suitable for working on chipboard panels, plywood, laminated, solid wood, corian-polymers and MDF.



DIMENSIONI DIMENSIONS							ARTICOLI ITEMS		PREZZI €
D	LU	LU2	DS	LS	LT	β°	Z EFF	DX / RH	PRICE €
DIAMETER	USEFUL LENGTH	USEFUL LENGTH	SHANK DIAMETER	SHANK LENGTH	TOTAL LENGTH	AXIAL ANGLE	ACTUAL TEETH	CODICE / SKU	
4	10	13	6	45	60	0°	1	FPD2001050	
5	10	13	6	45	60	0°	1	FPD2001004	
6	12	18	6	40	60	0°	1	FPD2001008	
6	15	18	6	40	60	0°	1	FPD2001052	
8	12	24	8	45	70	0°	1	FPD2001012	
8	12	24	12	45	70	0°	1	FPD2001014	
8	20	24	8	45	70	0°	1	FPD2001020	
10	15	28	10	45	75	0°	1	FPD2001034	
10	20	28	10	45	75	0°	1	FPD2001040	
12	20	28	12	45	75	0°	1	FPD2001048	

FULLCUT 2 EC1HN

FPD2003

FRESA DIAMANTE TAGLIANTE NEGATIVO Z1 CON CORPO HW
PCD SHANK CUTTER NEGATIVE CUT Z1 HW BODY

Fresa in diamante con tagliente negativo Z1, corpo fresa in HW integrale. Ottima per esecuzione di canali con massima finitura del pannello superficiale. Ideale per lavorazione di pannelli in truciolare rivestito, laminati, MDF rivestito e multistrato rivestito.

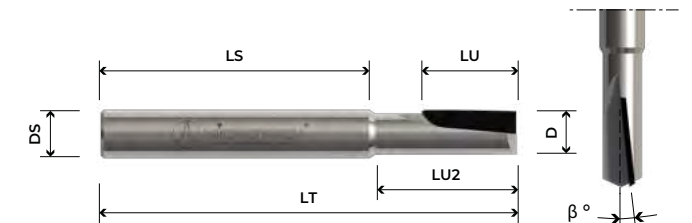

PCD shank cutter with negative cut Z1 carbide body. Suitable for working on chipboard panel, laminated and MDF.



DIMENSIONI DIMENSIONS							ARTICOLI ITEMS		PREZZI €
D	LU	LU2	DS	LS	LT	β°	Z EFF	DX / RH	PRICE €
DIAMETER	USEFUL LENGTH	USEFUL LENGTH	SHANK DIAMETER	SHANK LENGTH	TOTAL LENGTH	AXIAL ANGLE	ACTUAL TEETH	CODICE / SKU	
4	10	12	6	47	60	2°-	1	FPD2003046	
5	10	12	6	47	60	3°-	1	FPD2003044	
6	12	14	6	40	60	3°-	1	FPD2003002	
8	12	23	8	45	70	6°-	1	FPD2003006	
8	15	23	8	45	70	6°-	1	FPD2003010	
8	20	23	8	45	70	6°-	1	FPD2003014	
10	15	28	10	45	75	8°-	1	FPD2003026	
12	20	28	12	45	75	8°-	1	FPD2003042	

FULLCUT 3 EC2H

FPD2004

FRESA DIAMANTE TAGLIANTE DRITTO Z2 CON CORPO HW
PCD SHANK CUTTER STRAIGHT CUT Z2 HW BODY

Fresa in diamante con taglienti dritti Z2, corpo fresa in HW integrale. Ottima per lavorazione di pannelli in truciolare, MDF, multistrato, legni duri senza nodi e materiali polimerici.

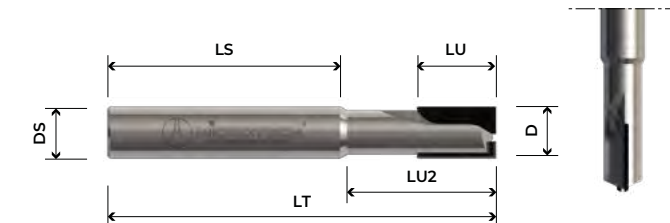

PCD shank cutter with straight cut Z2 carbide body. Suitable for working on chipboard panels, plywood, laminated, solid wood, corian-polymers and MDF.



DIMENSIONI DIMENSIONS							ARTICOLI ITEMS		PREZZI €
D	LU	LU2	DS	LS	LT	β°	Z EFF	DX / RH	PRICE €
DIAMETER	USEFUL LENGTH	USEFUL LENGTH	SHANK DIAMETER	SHANK LENGTH	TOTAL LENGTH	AXIAL ANGLE	ACTUAL TEETH	CODICE / SKU	
6	12	14	6	45	60	0°	2	FPD2004030	
8	12	24	8	45	70	0°	2	FPD2004002	
8	15	24	8	45	70	0°	2	FPD2004006	
10	15	28	10	45	75	0°	2	FPD2004016	
10	20	28	10	45	75	0°	2	FPD2004022	
10	25	28	10	45	75	0°	2	FPD2004032	
12	15	28	12	45	75	0°	2	FPD2004026	
12	20	28	12	45	75	0°	2	FPD2004028	
12	25	28	12	45	75	0°	2	FPD2004034	

FULLCUT 4 EC2HN

FPD2006

FRESA DIAMANTE TAGLIANTE NEGATIVO Z2 CON CORPO HW
PCD SHANK CUTTER NEGATIVE CUT Z2 HW BODY

Fresa in diamante con taglienti negativi Z2, corpo fresa in HW integrale. Ottima per esecuzione di canali su pannelli con massima finitura superficiale. Ideale per lavorazione di MDF rivestito, truciolare rivestito e multistrato laminato.

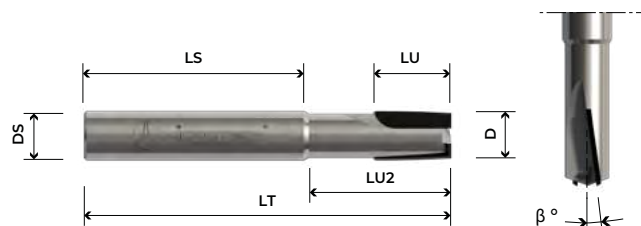

PCD shank cutter with negative cut Z2 carbide body. Suitable for grooving with excellent finishing on the panel surface to be used for working on chipboard panel, laminated and MDF.



DIMENSIONI DIMENSIONS							ARTICOLI ITEMS		PREZZI €
D	LU	LU2	DS	LS	LT	β°	Z EFF	DX / RH	PRICE €
DIAMETER	USEFUL LENGTH	USEFUL LENGTH	SHANK DIAMETER	SHANK LENGTH	TOTAL LENGTH	AXIAL ANGLE	ACTUAL TEETH	CODICE / SKU	
6	15	0	6	45	60	2°-	2	FPD2006036	
8	12	24	8	45	70	6°-	2	FPD2006002	
8	15	24	8	45	70	6°-	2	FPD2006006	
8	20	22	12	45	70	4°-	2	FPD2006030	
10	15	28	10	45	75	8°-	2	FPD2006016	
10	15	28	12	45	75	8°-	2	FPD2006018	
10	20	28	10	45	75	5°-	2	FPD2006022	
10	25	28	10	45	75	5°-	2	FPD2006032	
12	15	28	12	45	75	8°-	2	FPD2006026	
12	20	28	12	45	75	8°-	2	FPD2006028	
12	25	28	12	45	75	6°-	2	FPD2006034	

FULLCUT 5 EC2A

FPD2009

FRESA DIAMANTE TAGLIANTE DRITTO Z2 CORPO IN ACCIAIO
PCD SHANK CUTTER STRAIGHT CUT Z2 STEEL BODY

Fresa in diamante con taglienti dritti Z2, corpo fresa in acciaio. Ottima per lavorazione di pannelli in truciolare, MDF, multistrato, legni duri senza nodi e materiali polimerici.

PCD shank cutter with straight cut Z2 steel body. Suitable for working on chipboard panels, plywood, laminated, solid wood, corian-polymers and MDF.

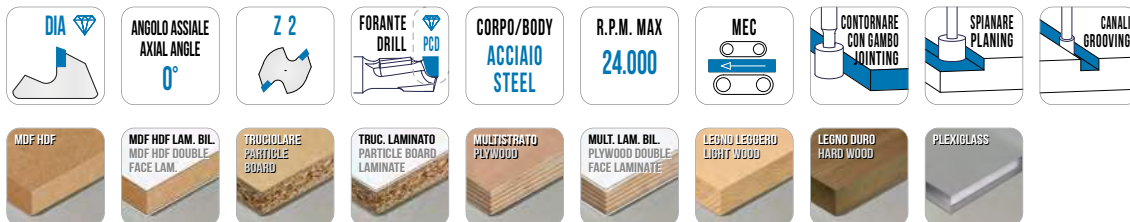
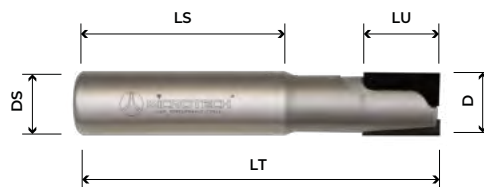

DIMENSIONI DIMENSIONS						ARTICOLI ITEMS			PREZZI €
D	LU	DS	LS	LT	β°	Z EFF	SX / LH	DX / RH	PRICE €
DIAMETER	USEFUL LENGHT	SHANK DIAMETER	SHANK LENGTH	TOT. LENGTH	AXIAL ANGLE	ACTUAL TEETH	CODICE / SKU	CODICE / SKU	
8	12	12	40	60	0	2	FPD2009003	FPD2009004	
10	15	12	40	63	0	2	FPD2009011	FPD2009012	
10	20	12	40	68	0	2	FPD2009071	FPD2009072	
12	15	12	40	63	0	2	FPD2009015	FPD2009016	
12	20	12	40	68	0	2	FPD2009017	FPD2009018	
12	25	12	40	73	0	2	FPD2009019	FPD2009020	
14	15	20	50	73	0	2	FPD2009023	FPD2009024	
16	20	16	50	78	0	2	FPD2009027	FPD2009028	
16	20	20	50	78	0	2	FPD2009029	FPD2009030	
16	25	16	50	83	0	2	FPD2009073	FPD2009074	
16	25	20	50	83	0	2	FPD2009075	FPD2009076	
16	30	16	50	88	0	2	FPD2009031	FPD2009032	
16	30	20	50	88	0	2	FPD2009033	FPD2009034	
18	20	20	50	78	0	2	FPD2009035	FPD2009036	
18	30	20	50	88	0	2	FPD2009037	FPD2009038	
18	35	20	50	93	0	2	FPD2009077	FPD2009078	
20	20	20	50	78	0	2	FPD2009039	FPD2009040	
20	30	20	50	88	0	2	FPD2009041	FPD2009042	
20	35	20	50	93	0	2	FPD2009065	FPD2009066	
20	35	25	55	98	0	2	FPD2009067	FPD2009068	
20	40	20	50	98	0	2	FPD2009043	FPD2009044	
25	25	25	55	88	0	2	FPD2009053	FPD2009054	
25	35	25	55	98	0	2	FPD2009055	FPD2009056	
25	45	25	55	108	0	2	FPD2009057	FPD2009058	
25	55	25	55	118	0	2	FPD2009059	FPD2009060	

FULLCUT 6 EC2AN FPD2010

FRESA DIAMANTE TAGLIENTE NEGATIVO Z2 CORPO IN ACCIAIO
PCD SHANK CUTTER NEGATIVE CUT Z2 STEEL BODY

Fresa in diamante con taglienti negativi Z2, corpo fresa in acciaio. Ottima per lavorazione di pannelli in truciolare, MDF, multistrato, legni duri senza nodi e materiali polimerici.

PCD shank cutter with negative cut Z2 steel body. Suitable for working on chipboard panels, plywood, laminated, solid wood, corian-polymers and MDF.

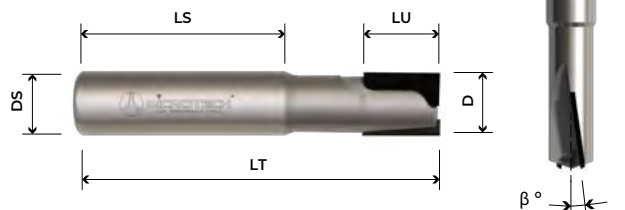

DIMENSIONI DIMENSIONS						ARTICOLI ITEMS			PREZZI €
D	LU	DS	LS	LT	β°	Z EFF	SX / LH	DX / RH	PRICE €
DIAMETER	USEFUL LENGHT	SHANK DIAMETER	SHANK LENGTH	TOT. LENGTH	AXIAL ANGLE	ACTUAL TEETH	CODICE / SKU	CODICE / SKU	
8	12	12	40	65	0	2	FPD2010003	FPD2010004	
10	15	12	40	65	0	2	FPD2010011	FPD2010012	
12	15	12	40	65	0	2	FPD2010015	FPD2010016	
12	20	12	40	70	0	2	FPD2010017	FPD2010018	
16	20	16	50	80	0	2	FPD2010027	FPD2010028	
16	20	20	50	80	0	2	FPD2010029	FPD2010030	
16	30	16	50	90	0	2	FPD2010031	FPD2010032	
16	30	20	50	90	0	2	FPD2010033	FPD2010034	
18	20	20	50	80	0	2	FPD2010035	FPD2010036	
18	30	20	50	90	0	2	FPD2010037	FPD2010038	
20	20	20	50	80	0	2	FPD2010039	FPD2010040	
20	30	20	50	90	0	2	FPD2010041	FPD2010042	
20	40	20	50	100	0	2	FPD2010043	FPD2010044	
20	40	25	50	100	0	2	FPD2010045	FPD2010046	
22	20	20	50	80	0	2	FPD2010047	FPD2010048	
22	30	20	50	90	0	2	FPD2010049	FPD2010050	
22	40	20	50	100	0	2	FPD2010051	FPD2010052	

FULLCUT 7 EC2HPN FPD2046

FRESA DIAMANTE TAGLIANTE ALTERNATO POSITIVO/NEGATIVO Z2 CON CORPO HW

PCD SHANK CUTTER WITH ALTERNATE CUT POSITIVE/NEGATIVE Z2 HW BODY

Fresa in diamante Z2 con assialità dei taglienti alternata, (1 tagliente positivo + 1 tagliente negativo), corpo fresa in HW integrale, forante in diamante. Consigliata per lavorazione di materiale compatti come HDF, HPL, pannelli in fibra di carbonio, tresa e corian.

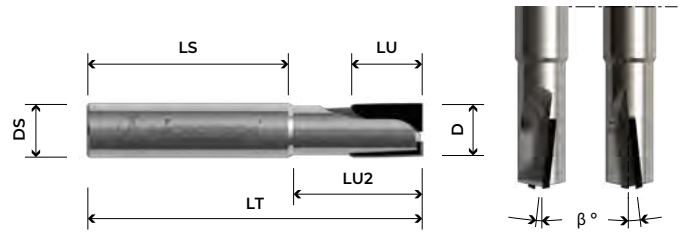

PCD shank cutter with alt. cut Z2 (1 positive cut - 1 negative cut) plung tip in PCD carbide body. Suitable for working on compact material HDF HPL corian carbon fiber and tresa.

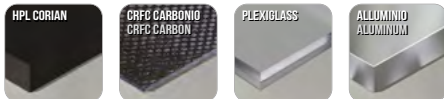
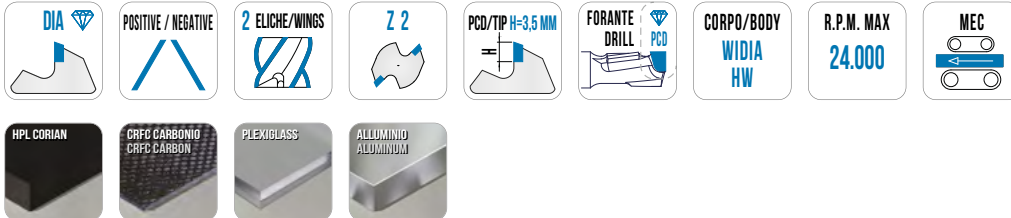

DIMENSIONI DIMENSIONS							ARTICOLI ITEMS	PREZZI €	
D	LU	LU2	DS	LS	LT	β°	Z EFF	DX / RH	PRICE €
DIAMETER	USEFUL LENGHT	USEFUL LENGHT	SHANK DIAMETER	SHANK LENGTH	TOTAL LENGTH	AXIAL ANGLE	ACTUAL TEETH	CODICE / SKU	
8	12	14	8	50	65	3°+/-	2	FPD2046002	
8	15	24	8	45	70	4°+/-	2	FPD2046006	
10	15	24	10	45	75	6°+/-	2	FPD2046016	
10	25	29	10	45	75	4°+/-	2	FPD2046030	
12	15	24	12	45	75	6°+/-	2	FPD2046026	
12	20	24	12	45	75	5°+/-	2	FPD2046028	
12	25	29	12	45	75	4°+/-	2	FPD2046032	

REFILCUT 1 RIFILATORE FPD2055

FRESA PER RIFILARE IN DIAMANTE DIA ROUTER BIT WITH COPYNG BEARING

Fresa per rifilare in diamante con cuscinetto.

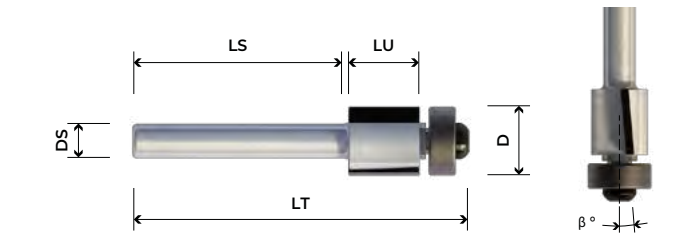

Dia router bit with copyng bearing.



DIMENSIONI DIMENSIONS							ARTICOLI ITEMS	PREZZI €
D	LU	DS	LS	LT	β°	Z EFF	DX / RH	PRICE €
DIAMETER	USEFUL LENGHT	SHANK DIAMETER	SHANK LENGTH	TOTAL LENGTH	AXIAL ANGLE	ACTUAL TEETH	CODICE / SKU	
12,7	13	6	39	58	5°-	2	FPD2055001	
12,7	13	8	39	58	5°-	2	FPD2055003	
12,7	26	8	38	70	5°-	2	FPD2055008	

POWERCUT 2 FPD2038

FRESA DIAMANTE TAGLIANTE ALTERNATO POSITIVO
NEGATIVO Z2 ROMPITRUCIOLO CORPO METALLO PESANTE

PCD SHANK CUTTER WITH ALTERNATE CUT POS./NEG. Z2
HDM BODY WITH ROUGH/FINISHING CUTTING TIPS

Fresa in diamante riaffilabile a tagliente intero, angolo assiale alternato (1 positivo - 1 negativo), tagliente sgrassatore - finitore, altezza PCD 3,0 mm, corpo in metallo pesante HDM, adatta per lavorazioni di nesting su MDF, HDF, HPL, pannelli fibra di carbonio, trespa e corian.

Re-sharpening shank cutter in diamond with full tips, cutting angle (1 positive - 1 negative), rough/finishing cutting tips PCD 3,0 mm, HDM body, tool suitable for nesting operation on MDF, HDF, HPL, panels also in carbon fibre, trespa and corian.

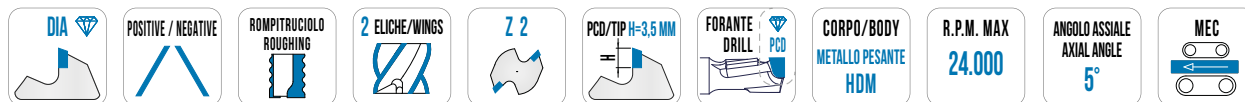
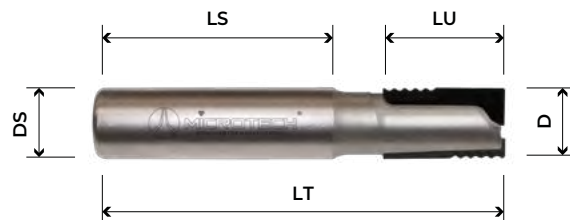

DIMENSIONI DIMENSIONS						ARTICOLI ITEMS			PREZZI €	
D	LU	DS	LS	LT	β°	Z EFF	H PAN	SX / LH	DX / RH	PRICE €
DIAMETER	USEFUL LENGTH	SHANK DIAMETER	SHANK LENGTH	T. LENGTH	AXIAL ANGLE	ACTUAL TEETH	PANEL H WORKED	CODICE / SKU	CODICE / SKU	
12	19	12	40	65	4°+/-	2	DA 12 A 16	FPD2038001	FPD2038002	
12	24	12	40	70	4°+/-	2	DA 16 A 21	FPD2038007	FPD2038008	
12	28	12	40	75	4°+/-	2	DA 22 A 25	FPD2038013	FPD2038014	

POWERCUT 3 FPD2039

FRESA DIAMANTE TAGLIANTE ALTERNATO POSITIVO
NEGATIVO Z4 ROMPITRUCIOLO CORPO METALLO PESANTE

PCD SHANK CUTTER WITH ALTERNATE CUT POS./NEG. Z4
HDM BODY WITH ROUGH/FINISHING CUTTING TIPS

Fresa in diamante riaffilabile a taglienti interi, angolo assiale alternato (2 positivi - 2 negativi), corpo in metallo pesante HDM, taglienti sgrassatori - finitori, altezza PCD 3,0 mm, adatta per lavorazioni di nesting su pannelli di M.D.F., H.D.F., H.P.L., pannelli fibra di carbonio, trespa, corian. Alta velocità di avanzamento, estrazione del truciolo, ottima asportazione, eccellente finitura, bassa rumorosità.

Re-sharpening shank cutter with full tips, cutting angle (2 positive - 2 negative), rough/finishing cutting tips PCD 3,0 mm, HDM body, tool suitable for nesting operation on MDF, HDF, HPL, panels also in carbon fibre, trespa and corian.

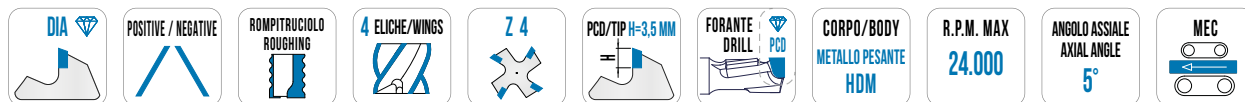
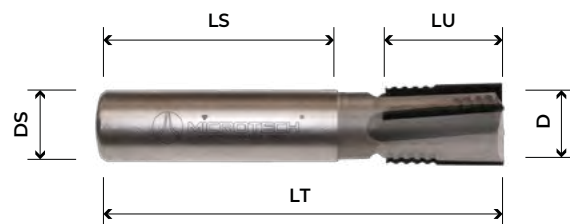

DIMENSIONI DIMENSIONS						ARTICOLI ITEMS			PREZZI €	
D	LU	DS	LS	LT	β°	Z EFF	H PAN	SX / LH	DX / RH	PRICE €
DIAM.	USEFUL L.	SHANK DIAM.	SHANK L.	T. LENGTH	AXIAL ANGLE	ACTUAL TEETH	PANEL H WORKED	CODICE / SKU	CODICE / SKU	
10	12	10	40	60	4°+/-	4	DA 8 A 11	FPD2039019	FPD2039020 NEW	
12	19	12	40	65	4°+/-	4	DA 12 A 16	FPD2039001	FPD2039002	
12	24	12	40	70	4°+/-	4	DA 16 A 21	FPD2039007	FPD2039008	
12	24	20	50	80	4°+/-	4	DA 16 A 21	FPD2039011	FPD2039012	
12	28	12	40	75	4°+/-	4	DA 22 A 25	FPD2039013	FPD2039014	

ECOCUT 1 EC2E FPD2011

FRESA ELICOIDALE IN DIAMANTE Z1+1 PCD H2,5 MM

PCD HELICOIDAL SHANK CUTTER Z1+1 PCD H2,5 MM

Fresa in diamante Z1+1, placchetta in diamante economico H2,5mm riaffilabile massimo 3 volte. 2 divisioni in elica, prima placchetta positiva, il resto negative. Forante in HW e corpo in acciaio o metallo pesante. Ottima per lavorazione di pannelli in truciolare rivestito, pannelli laminati, MDF rivestito e legni duri senza nodi.

PCD shank cutter Z1+1 with eco PCD tips H2,5mm resharpened up to 3 times two helicoidal wing, first tip positive all the others negative, plunge tip in HW steel body or HDM body. Suitable for working on chipboard panels, plywood, laminated, solid wood and MDF.

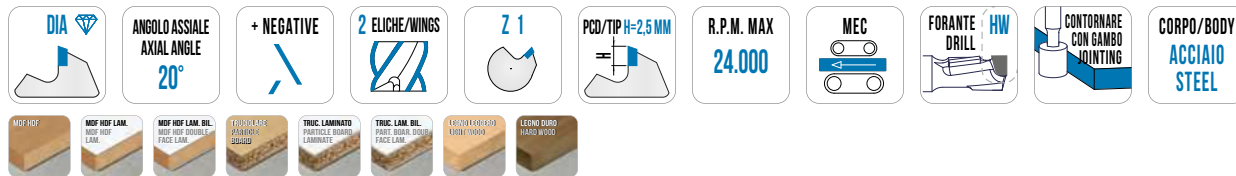
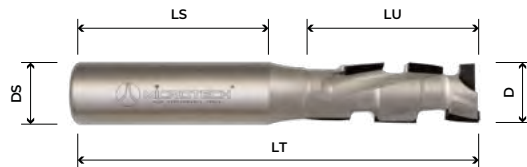

CORPO ACCIAIO / STEEL BODY					DIMENSIONI DIMENSIONS					ARTICOLI ITEMS		PREZZI €
D	LU	DS	LS	LT	β°	DRILLING TYPE	Z TOT	Z EFF	SX / LH	DX / RH	PRICE €	
DIAMETER	USEFUL LENGTH	SHANK DIAM.	SHANK LENGTH	T. LENGTH	AXIAL ANGLE		T. TEETH	ACTUAL TEETH	CODICE / SKU	CODICE / SKU		
8	27	10	40	75	10°	HW	3	1+1	FPD2011123	FPD2011124		
8	27	12	40	75	10°	HW	3	1+1	FPD2011125	FPD2011126		
10	27	12	40	75	10°	HW	3	1+1	FPD2011115	FPD2011116		
12	27	12	40	75	10°	HW	3	1+1	FPD2011033	FPD2011034		
16	27	16	50	85	18°	HW	3	1+1	FPD2011039	FPD2011040		
16	27	20	50	85	18°	HW	3	1+1	FPD2011041	FPD2011042		
16	35	16	50	95	18°	HW	4	1+1	FPD2011045	FPD2011046		
16	35	20	50	95	18°	HW	4	1+1	FPD2011047	FPD2011048		
16	43	16	50	103	18°	HW	5	1+1	FPD2011051	FPD2011052		
16	43	20	50	103	18°	HW	5	1+1	FPD2011053	FPD2011054		

ECOCUT 2 EC2EH HDM FPD2053

FRESA ELICOIDALE IN DIAMANTE Z1+1 PCD H2,5 MM

PCD HELICOIDAL SHANK CUTTER Z1+1 PCD H2,5 MM

Fresa in diamante Z1+1, placchetta in diamante economico H2,5mm riaffilabile massimo 3 volte. 2 divisioni in elica, prima placchetta positiva, il resto delle placchette negative. Forante in diamante e corpo metallo pesante DENSIMET ad alta resistenza per piccoli diametri. Ottima per lavorazione di pannelli in truciolare rivestito, pannelli laminati, MDF rivestito, legni duri senza nodi.

PCD shank cutter Z1+1 with eco PCD tips H2,5mm resharpened up to 3 times two helicoidal wing, first tip positive all the others negative, plunge tip in DIA steel body or HDM body. Suitable for working on chipboard panels, plywood, laminated, solid wood and MDF.

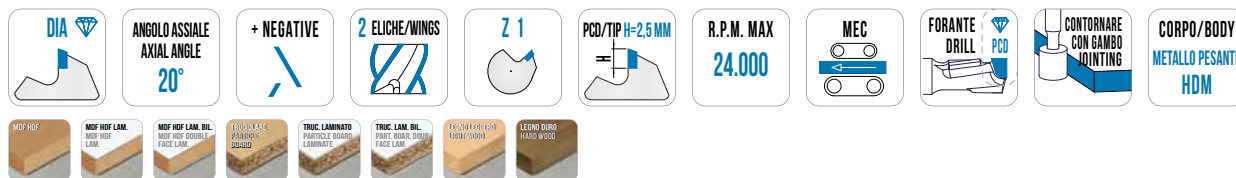
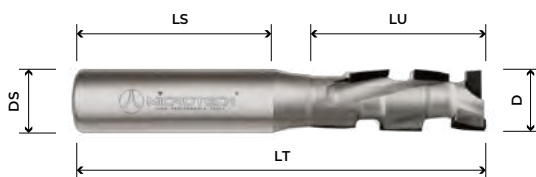

CORPO METALLO PESANTE / HDM BODY					DIMENSIONI DIMENSIONS					ARTICOLI ITEMS		PREZZI €
D	LU	DS	LS	LT	β°	DRILLING TYPE	Z TOT	Z EFF	SX / LH	DX / RH	PRICE €	
DIAMETER	USEFUL LENGTH	SHANK DIAM.	SHANK LENGTH	TOT. LENGTH	AXIAL ANGLE		T. TEETH	ACTUAL TEETH	CODICE / SKU	CODICE / SKU		
8	18	8	40	68	5°	DIA	3	1	FPD2053001	FPD2053002		
8	18	10	40	68	5°	DIA	3	1	FPD2053003	FPD2053004		
8	27	8	40	75	5°	DIA	4	1	FPD2053007	FPD2053008		
8	27	10	40	75	5°	DIA	4	1	FPD2053009	FPD2053010		
8	27	12	40	75	5°	DIA	4	1	FPD2053011	FPD2053012		
8	35	8	40	85	5°	DIA	5	1	FPD2053013	FPD2053014		
8	35	10	40	85	5°	DIA	5	1	FPD2053015	FPD2053016		
8	35	12	40	85	5°	DIA	5	1	FPD2053017	FPD2053018		
10	17	10	40	67	10°	DIA	3	1	FPD2053019	FPD2053020		
10	17	12	40	67	10°	DIA	3	1	FPD2053021	FPD2053022		
10	27	10	40	75	10°	DIA	4	1	FPD2053023	FPD2053024		
10	27	12	40	75	10°	DIA	4	1	FPD2053025	FPD2053026		
10	36	10	40	86	10°	DIA	5	1	FPD2053027	FPD2053028		
10	36	12	40	86	10°	DIA	5	1	FPD2053029	FPD2053030		
12	27	12	40	75	10°	DIA	4	1	FPD2053033	FPD2053034		
12	34	12	40	84	10°	DIA	5	1	FPD2053035	FPD2053036		
12	43	12	40	93	10°	DIA	6	1	FPD2053037	FPD2053038		

ECOCUT 3 EC3E FPD2012

FRESA ELICOIDALE IN DIAMANTE Z1+1 CORPO IN ACCIAIO PCD H2,5 MM

PCD HELICOIDAL SHANK CUTTER Z1+1 STEEL BODY PCD H2,5 MM

Fresa in diamante Z1+1, placchetta in diamante economico H2,5 mm (riaffilabile massimo 3 volte), 3 divisioni in elica, prima placchetta positiva, il resto negative. Forante in HW e corpo in acciaio.

PCD shank cutter Z1+1 with eco PCD tips H2,5 mm resharpened up to 3 times three helicoidal wing, first tip positive all the others negative, plunge tip in HW, steel body.

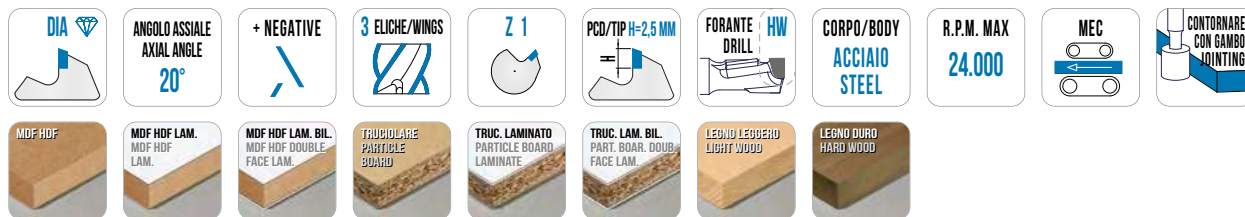
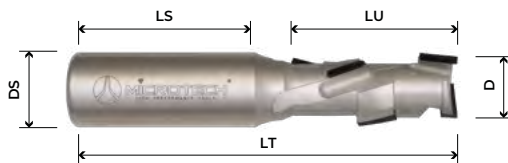

DIMENSIONI DIMENSIONS						ARTICOLI ITEMS				PREZZI €
D	LU	DS	LS	LT	β°	Z TOT	Z EFF	SX / LH	DX / RH	PRICE €
DIAMETER	USEFUL LENGTH	SHANK DIAMETER	SHANK LENGTH	TOT. LENGTH	AXIAL ANGLE	TOT. TEETH	ACTUAL TEETH	CODICE / SKU	CODICE / SKU	
10	27	10	40	75	10°	3	1+1	FPD2012149	FPD2012150	
10	27	12	40	75	10°	3	1+1	FPD2012001	FPD2012002	
12	27	12	40	75	10°	3	1+1	FPD2012009	FPD2012010	
12	34	12	40	84	10°	4	1+1	FPD2012017	FPD2012018	
12	43	12	40	93	10°	5	1+1	FPD2012025	FPD2012026	
16	27	16	50	85	20°	3	1+1	FPD2012057	FPD2012058	
16	27	20	50	85	20°	3	1+1	FPD2012059	FPD2012060	
16	34	16	50	94	20°	4	1+1	FPD2012063	FPD2012064	
16	34	20	50	94	20°	4	1+1	FPD2012065	FPD2012066	
16	43	16	50	103	20°	5	1+1	FPD2012069	FPD2012070	
16	43	20	50	103	20°	5	1+1	FPD2012071	FPD2012072	
18	27	20	50	85	20°	3	1+1	FPD2012081	FPD2012082	
18	34	20	50	94	20°	4	1+1	FPD2012085	FPD2012086	
18	43	20	50	103	20°	5	1+1	FPD2012089	FPD2012090	
20	27	20	50	85	20°	3	1+1	FPD2012101	FPD2012102	
20	35	20	50	95	20°	4	1+1	FPD2012105	FPD2012106	
20	43	20	50	103	20°	5	1+1	FPD2012109	FPD2012110	
20	52	20	50	112	20°	6	1+1	FPD2012113	FPD2012114	
20	61	20	50	121	20°	7	1+1	FPD2012117	FPD2012118	
20	70	20	50	130	20°	8	1+1	FPD2012121	FPD2012122	
25	34	25	55	99	20°	4	1+1	FPD2012133	FPD2012134	
25	43	25	55	108	20°	5	1+1	FPD2012135	FPD2012136	
25	52	25	55	117	20°	6	1+1	FPD2012137	FPD2012138	
25	61	25	55	126	20°	7	1+1	FPD2012139	FPD2012140	
25	76	25	55	126	21°	9	1+1	FPD2012151	FPD2012152	
25	87	25	55	126	22°	10	1+1	FPD2012161	FPD2012162	
25	95	25	55	126	23°	11	1+1	FPD2012155	FPD2012156	
25	105	25	55	126	24°	12	1+1	FPD2012157	FPD2012158	
25	113	25	55	126	25°	13	1+1	FPD2012159	FPD2012160	

ECOCUT PLUS 1 RC3 FPD2013

FRESA ELICOIDALE IN DIAMANTE Z1+1 CORPO IN ACCIAIO PCD H4,5 MM

PCD HELICOIDAL SHANK CUTTER Z1+1 STEEL BODY PCD H4,5 MM

Fresa in diamante Z1+1, placchetta in diamante H4,5 mm (riaffilabile 8 volte), 3 divisioni in elica, prima placchetta positiva, il resto negative. Forante in HW e corpo in acciaio. Ottima per lavorazione di pannelli in truciolare rivestito, laminati, MDF rivestito e legni duri senza nodi.

PCD shank cutter Z1+1 with eco PCD tips H4,5 mm resharpened up to 8 times three helicoidal wing, first tip positive all the others negative, plunge tip in HW steel body. Suitable for working on chipboard panels, plywood, laminated, solid wood and MDF.

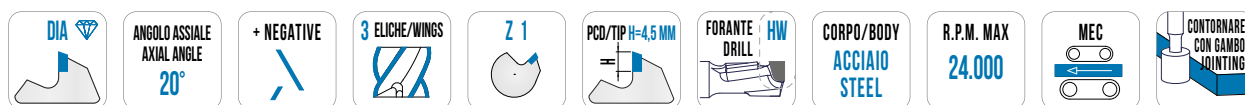
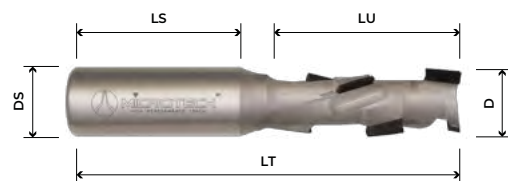

DIMENSIONI DIMENSIONS						ARTICOLI ITEMS				PREZZI €
D	LU	DS	LS	LT	β°	Z TOT	Z EFF	SX / LH	DX / RH	PRICE €
DIAMETER	USEFUL LENGTH	SHANK DIAMETER	SHANK LENGTH	TOT. LENGTH	AXIAL ANGLE	TOT. TEETH	ACTUAL TEETH	CODICE / SKU	CODICE / SKU	
20	27	20	50	85	20°	3	1+1	FPD2013001	FPD2013002	
20	35	20	50	95	20°	4	1+1	FPD2013005	FPD2013006	
20	43	20	50	103	20°	5	1+1	FPD2013009	FPD2013010	
20	52	20	50	112	20°	6	1+1	FPD2013013	FPD2013014	
20	61	20	50	121	20°	7	1+1	FPD2013017	FPD2013018	

ECOCUT 5 EC3H FPD2045

FRESA ELICOIDALE IN DIAMANTE Z1+1 CORPO IN HW PCD H2,5 MM

PCD HELICOIDAL SHANK CUTTER Z1+1 HW BODY PCD H2,5 MM

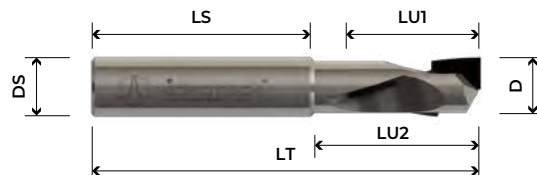

Fresa in diamante Z1+1, placchetta in diamante economico H2,5 mm riaffilabile massimo 3 volte. Tre divisioni in elica, prima placchetta positiva, il resto negative. Forante in diamante e corpo in HW.

PCD shank cutter Z1+1 with eco PCD tips H2,5 mm resharpened up to 3 times three helicoidal wing, first tip positive all the others negative, plunge tip in HW, HW body.

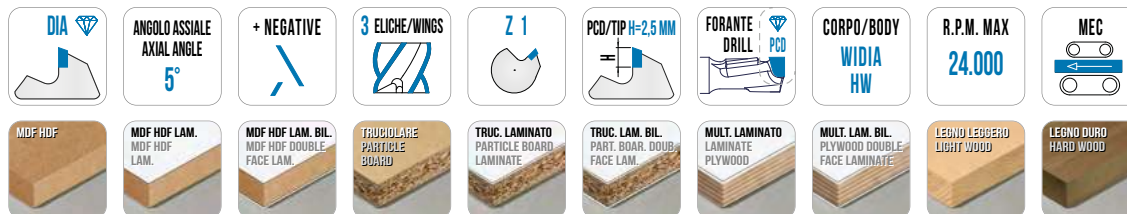

DIMENSIONI DIMENSIONS										ARTICOLI ITEMS		PREZZI €
D	LU	LU2	DS	LS	LT	β°	Z TOT	Z EFF	SX / LH	DX / RH	PRICE €	
DIAM.	USEFUL LENGHT	USEFUL LENGHT	SHANK DIAM.	SHANK LENGTH	TOT. LENGTH	AXIAL ANGLE	TOT. TEETH	ACTUAL TEETH	CODICE / SKU	CODICE / SKU		
6	18	25	8	40	65	8+/-	2	1+1	FPD2045049	FPD2045050		
8	18	25	8	40	65	8+/-	2	1+1	FPD2045047	FPD2045048		
8	27	34	8	40	75	8+/-	3	1+1	FPD2045011	FPD2045012		
8	35	39	8	40	80	8+/-	4	1+1	FPD2045017	FPD2045018		
8	44	49	8	40	90	8+/-	5	1+1	FPD2045045	FPD2045046		
10	18	25	10	40	65	12+/-	2	1+1	FPD2045051	FPD2045052		
10	27	34	10	40	75	12+/-	3	1+1	FPD2045025	FPD2045026		
10	35	39	10	40	80	12+/-	4	1+1	FPD2045029	FPD2045030		
10	44	49	10	40	90	12+/-	5	1+1	FPD2045033	FPD2045034		
12	27	34	12	40	75	15+/-	3	1+1	FPD2045039	FPD2045040		
12	35	39	12	40	80	15+/-	4	1+1	FPD2045041	FPD2045042		
12	44	49	12	40	90	15+/-	5	1+1	FPD2045043	FPD2045044		
14	35	40	14	40	80	15+/-	4	1+1	FPD2045055	FPD2045056		
14	43	49	14	40	90	15+/-	5	1+1	FPD2045053	FPD2045054		

ECOCUT 6 EC4E FPD2015

FRESA ELICOIDALE IN DIAMANTE Z2+2 CORPO IN ACCIAIO PCD H2,5 MM

PCD HELICOIDAL SHANK CUTTER Z2+2 STEEL BODY PCD H2,5 MM

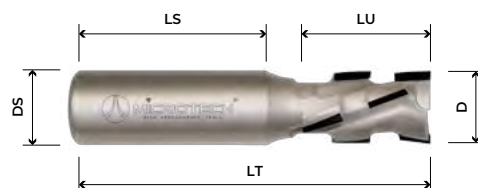

Fresa in diamante Z2+2, con placchetta riaffilabile H2,5 mm, 4 divisioni in elica, prima placchetta positiva traente con il resto delle placchette negative. Forante in HW, angolo assiale di 20+/-.

PCD shank cutter Z2+2 with PCD tips H2,5 mm, 4 helicoidal wing, first tip positive all the others negative, plunge tip in HW steel body cutting angle 20°. Suitable for working on chipboard panels, plywood, laminated, solid wood and MDF.

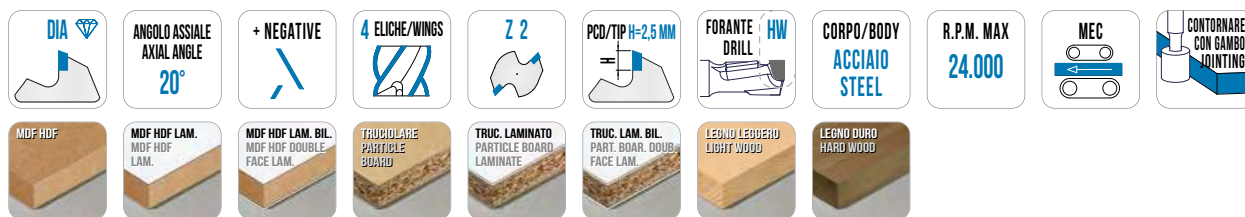

DIMENSIONI DIMENSIONS										ARTICOLI ITEMS		PREZZI €
D	LU	DS	LS	LT	β°	Z TOT	Z EFF	SX / LH	DX / RH	PRICE €		
DIAMETER	USEFUL LENGHT	SHANK DIAMETER	SHANK LENGTH	TOT. LENGTH	AXIAL ANGLE	TOT. TEETH	ACTUAL TEETH	CODICE / SKU	CODICE / SKU			
12	27	12	40	75	10°	6	2+2	FPD2015001	FPD2015002			
12	34	12	40	84	10°	8	2+2	FPD2015007	FPD2015008			
16	27	16	50	85	18°	6	2+2	FPD2015031	FPD2015032			
16	27	20	50	85	18°	6	2+2	FPD2015033	FPD2015034			
16	34	16	50	94	18°	8	2+2	FPD2015037	FPD2015038			
16	34	20	50	94	18°	8	2+2	FPD2015039	FPD2015040			
18	27	20	50	85	20°	6	2+2	FPD2015055	FPD2015056			
18	34	20	50	94	20°	8	2+2	FPD2015059	FPD2015060			
18	43	20	50	103	20°	10	2+2	FPD2015063	FPD2015064			
20	25	20	50	85	20°	6	2+2	FPD2015075	FPD2015076			
20	34	20	50	94	20°	8	2+2	FPD2015079	FPD2015080			
20	43	20	50	103	20°	10	2+2	FPD2015083	FPD2015084			
20	52	20	50	112	20°	12	2+2	FPD2015087	FPD2015088			
20	61	20	50	121	20°	14	2+2	FPD2015091	FPD2015092			
20	70	20	50	130	20°	16	2+2	FPD2015095	FPD2015096			

ECOCUT PLUS 2 RC4 FPD2016

FRESA ELICOIDALE IN DIAMANTE Z2+2
CORPO IN ACCIAIO PCD H4,5 MM

PCD HELICOIDAL SHANK CUTTER Z2+2
STEEL BODY PCD H4,5 MM

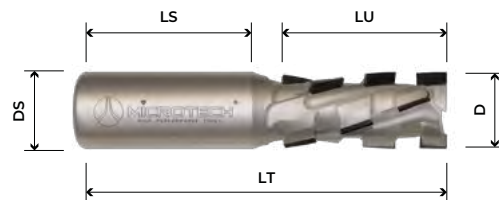

Fresa in diamante Z2+2, con placchetta H4,5 mm (max 8 riaffilature), 4 divisioni in elica, prima placchetta positiva con il resto delle placchette negative. Forante in HW, angolo assiale 20°+/-.
Corpo fresa in acciaio speciale. Ottima per lavorazione di pannelli in truciolare rivestivo, pannelli laminati, nobilitati, MDF rivestivi, multistrati rivestiti, legni duri senza nodi e materiali polimerici.

PCD shank cutter Z2+2 with PCD tips H4,5 mm resharpened up to 8 times four helicoidal wing, first tip positive all the others negative, plunge tip in HW steel body cutting angle 20°.
Suitable for working on chipboard panels, plywood, laminated, solid wood, MDF and polymers.



DIMENSIONI DIMENSIONS					ARTICOLI ITEMS		PREZZI €			
D	LU	DS	LS	LT	β°	Z TOT	Z EFF	SX / LH	DX / RH	PRICE €
DIAMETER	USEFUL LENGHT	SHANK DIAMETER	SHANK LENGTH	TOT. LENGTH	AXIAL ANGLE	TOT. TEETH	ACTUAL TEETH	CODICE / SKU	CODICE / SKU	
18	27	20	50	85	20°	6	2+2	FPD2016001	FPD2016002	
18	34	20	50	95	20°	8	2+2	FPD2016005	FPD2016006	
20	27	20	50	85	20°	6	2+2	FPD2016013	FPD2016014	
20	34	20	50	95	20°	8	2+2	FPD2016017	FPD2016018	
20	43	20	50	103	20°	10	2+2	FPD2016021	FPD2016022	
20	52	20	50	112	20°	12	2+2	FPD2016025	FPD2016026	
25	27	25	55	90	20°	6	2+2	FPD2016037	FPD2016038	
25	34	25	55	100	20°	8	2+2	FPD2016039	FPD2016040	
25	43	25	55	108	20°	10	2+2	FPD2016041	FPD2016042	
25	52	25	55	117	20°	12	2+2	FPD2016043	FPD2016044	
25	61	25	55	126	20°	14	2+2	FPD2016045	FPD2016046	
25	70	25	55	135	20°	16	2+2	FPD2016047	FPD2016048	
25	75	25	55	140	20°	18	2+2	FPD2016049	FPD2016050	
25	87	25	55	152	20°	20	2+2	FPD2016051	FPD2016052	
25	105	25	55	170	20°	24	2+2	FPD2016053	FPD2016054	
25	112	25	55	177	20°	26	2+2	FPD2016055	FPD2016056	

ECOCUT 8 EC4S FPD2017

FRESA ELICOIDALE IN DIAMANTE Z1+1 / 2+2
CORPO IN ACCIAIO PCD H2,5 MM

PCD HELICOIDAL SHANK CUTTER Z1+1 / 2+2
STEEL BODY PCD H 2,5 MM

Fresa in diamante Z2+2 nella parte di taglio superiore e inferiore, Z1+1 nella parte centrale, con placchetta economica H2,5 mm (max 3 riaffilature), 4 divisioni in elica, prima placchetta positiva con il resto delle placchette negative. Forante in HW, angolo assiale 20°+/- . Corpo fresa in acciaio speciale, ottima per lavorazione di pannelli in truciolare rivestito, pannelli laminati, nobilitati, MDF rivestiti, legni duri senza nodi, materiali polimerici.

PCD shank cutter Z2+2 on top and bottom part Z1+1 in the middle part with PCD tips H2,5 mm resharpened up to 3 times four helicoidal wing, first tip positive all the others negative, plunge tip in HW, steel body cutting angle 20°. Suitable for working on chipboard panels, plywood, laminated, solid wood, MDF and polymers.

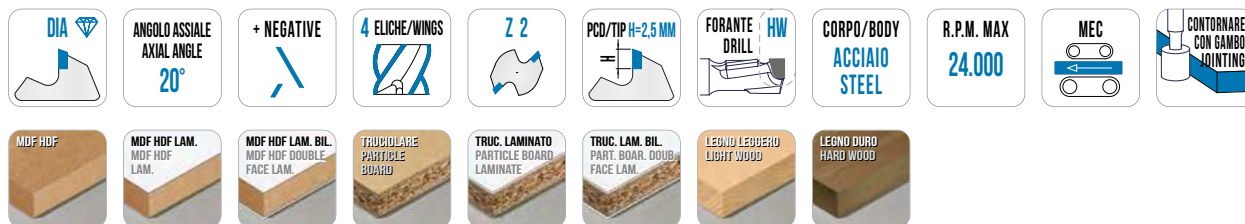
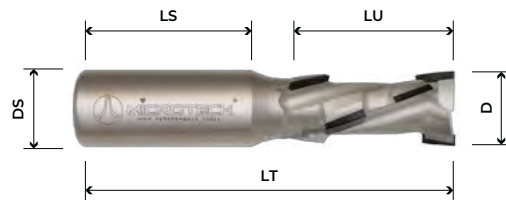

DIMENSIONI DIMENSIONS						ARTICOLI ITEMS		PREZZI €		
D	LU	DS	LS	LT	β°	Z TOT	Z EFF	SX / LH	DX / RH	PRICE €
DIAMETER	USEFUL LENGHT	SHANK DIAMETER	SHANK LENGTH	TOT. LENGTH	AXIAL ANGLE	TOT. TEETH	ACTUAL TEETH	CODICE / SKU	CODICE / SKU	
12	35	12	40	80	20°	6	2+2 / 1+1	FPD2017003	FPD2017004	
16	26	16	50	86	18°	5	2+2 / 1+1	FPD2017005	FPD2017006	
16	35	16	50	95	18°	6	2+2 / 1+1	FPD2017011	FPD2017012	
18	35	20	50	95	20°	6	2+2 / 1+1	FPD2017027	FPD2017028	
18	43	20	50	103	20°	7	2+2 / 1+1	FPD2017031	FPD2017032	
20	35	20	50	95	20°	6	2+2 / 1+1	FPD2017043	FPD2017044	
20	43	20	50	103	20°	7	2+2 / 1+1	FPD2017047	FPD2017048	
20	52	20	50	112	20°	8	2+2 / 1+1	FPD2017051	FPD2017052	

REFILCUT 2 EC3EB FPD2014

FRESA ELICOIDALE IN DIAMANTE CON CUSCINETTO Z1+1
CORPO IN ACCIAIO PCD H2,5 MM

PCD HELICOIDAL SHANK CUTTER Z1+1
WITH COPY BEARING STEEL BODY PCD H2,5 MM

Fresa in diamante Z1+1 con cuscinetto di battuta, placchetta in diamante economico H2,5 mm (riaffilabile massimo 3 volte), 3 divisioni in elica, prima placchetta positiva, il resto delle placchette negative. Ottima per lavorazione di refilatura e contornatura di pannelli in truciolare rivestito, pannelli laminati, MDF rivestito e legni duri senza nodi.

PCD shank cutter Z1+1 with copy bearing, eco PCD tips H2,5 mm resharpened up to 3 times three helicoidal wing, first tip positive all the others negative. Suitable for working on chipboard panels, plywood, laminated, solid wood and MDF.

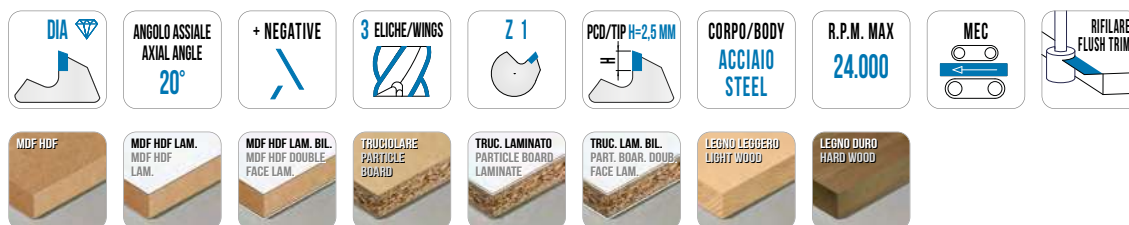
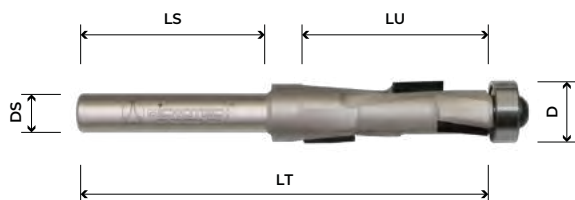

DIMENSIONI DIMENSIONS						ARTICOLI ITEMS		PREZZI €		
D	LU	DS	LS	LT	β°	Z TOT	Z EFF	SX / LH	DX / RH	PRICE €
DIAMETER	USEFUL LENGHT	SHANK DIAMETER	SHANK LENGTH	TOT. LENGTH	AXIAL ANGLE	TOT. TEETH	ACTUAL TEETH	CODICE / SKU	CODICE / SKU	
12,7	27	8	40	81	10°	3	1+1	FPD2014001	FPD2014002	
12,7	27	12	40	81	10°	3	1+1	FPD2014003	FPD2014004	
12,7	34	8	40	90	10°	4	1+1	FPD2014005	FPD2014006	
12,7	34	12	40	90	10°	4	1+1	FPD2014007	FPD2014008	
12,7	43	12	40	99	10°	5	1+1	FPD2014011	FPD2014012	
24	27	12	51	80	10°	3	1+1	FPD2014013	FPD2014014	
24	35	12	51	88	10°	4	1+1	FPD2014015	FPD2014016	
24	43	12	40	99	10°	5	1+1	FPD2014017	FPD2014018	

ECX3 FPD2020

FRESA ELICOIDALE IN DIAMANTE Z2+2
CORPO IN ACCIAIO PCD H2,5 MM

PCD HELICOIDAL SHANK CUTTER Z2+2
STEEL BODY PCD H2,5 MM

Fresa in diamante Z2+2, con placchetta economica H2,5 mm (max 3 riaffilature), 3 divisioni in elica, prima placchetta positiva traente con il resto delle placchette negative. Forante in HW, angolo assiale 20°+/-, corpo in acciaio speciale. Ottima per lavorazione di pannelli in truciolare rivestivo, pannelli laminati, nobilitati, MDF rivestivi, legni duri senza nodi e materiali polimerici.

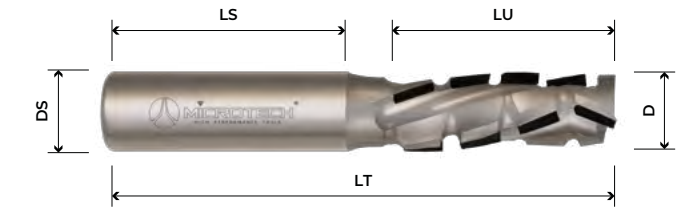

PCD shank cutter Z2+2 with eco PCD tips H2,5 mm resharpened up to 3 times three helicoidal wing, first tip positive all the others negative, plunge tip in HW, cutting angle 20° steel body. Suitable for working on chipboard panels, laminated, solid wood, MDF and polymers.

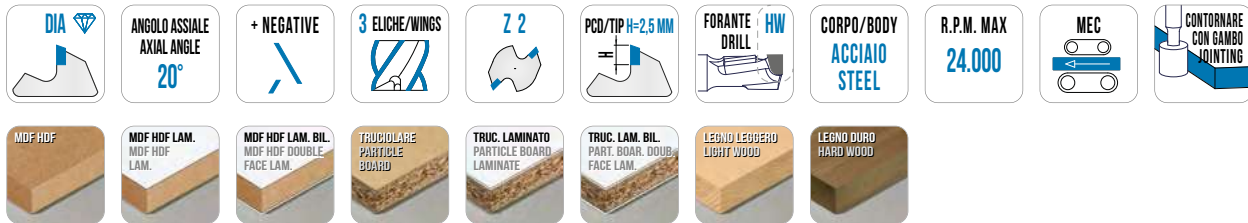

DIMENSIONI DIMENSIONS					ARTICOLI ITEMS		PREZZI €			
D	LU	DS	LS	LT	β°	Z TOT	Z EFF	SX / LH	DX / RH	PRICE €
DIAMETER	USEFUL LENGHT	SHANK DIAMETER	SHANK LENGTH	TOT. LENGTH	AXIAL ANGLE	TOT. TEETH	ACTUAL TEETH	CODICE / SKU	CODICE / SKU	
16	35	16	50	95	20°	9	2+2	FPD2020005	FPD2020006	
16	35	20	50	95	20°	9	2+2	FPD2020007	FPD2020008	
16	46	16	50	106	20°	12	2+2	FPD2020009	FPD2020010	
16	46	20	50	106	20°	12	2+2	FPD2020011	FPD2020012	
18	35	20	50	95	20°	9	2+2	FPD2020021	FPD2020022	
18	46	20	50	106	20°	12	2+2	FPD2020025	FPD2020026	

RX3 FPD2021

FRESA ELICOIDALE IN DIAMANTE Z2+2
CORPO IN ACCIAIO PCD H4,5 MM

PCD HELICOIDAL SHANK CUTTER Z2+2
STEEL BODY PCD H4,5 MM

Fresa in diamante Z2+2, con placchetta H4,5 mm (max 8 riaffilature), 3 divisioni in elica, prima placchetta positiva traente con il resto delle placchette negative. Forante in diamante, angolo assiale 20°+/-, corpo in acciaio speciale. Ottima per lavorazione di pannelli in truciolare rivestivo, pannelli laminati, nobilitati, MDF rivestivi, legni duri senza nodi e materiali polimerici.

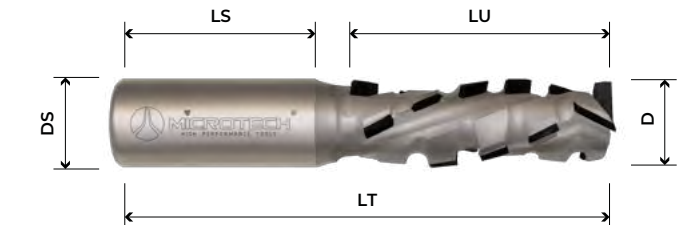

PCD shank cutter Z2+2 with PCD tips H4,5 mm resharpened up to 8 times three helicoidal wing, first tip positive all the others negative, plunge tip in PCD, cutting angle 20° steel body. Suitable for working on chipboard panels, laminated, solid wood, MDF and polymers.

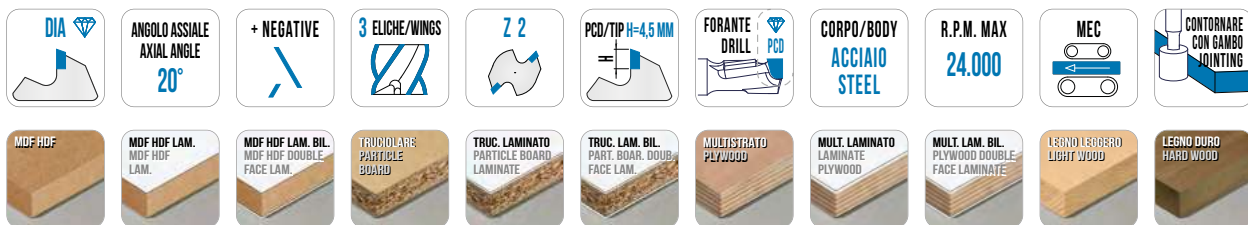

DIMENSIONI DIMENSIONS					ARTICOLI ITEMS		PREZZI €			
D	LU	DS	LS	LT	β°	Z TOT	Z EFF	SX / LH	DX / RH	PRICE €
DIAMETER	USEFUL LENGHT	SHANK DIAMETER	SHANK LENGTH	TOT. LENGTH	AXIAL ANGLE	TOT. TEETH	ACTUAL TEETH	CODICE / SKU	CODICE / SKU	
20	44	20	50	104	20°	10	2+2	FPD2021009	FPD2021010	
20	53	20	50	113	20°	12	2+2	FPD2021013	FPD2021014	
22	44	20	50	104	22°	10	2+2	FPD2021029	FPD2021030	
22	53	20	50	113	22°	12	2+2	FPD2021033	FPD2021034	

ULTRACUT 1 UL FPD2024

FRESA ELICOIDALE IN DIAMANTE Z3+3 CORPO IN ACCIAIO PCD H4,5 MM

PCD HELICOIDAL SHANK CUTTER Z3+3 STEEL BODY PCD H4,5 MM

Fresa in diamante Z3+3, con placchetta riaffilabile H4,5 mm (max 8 riaffilature), 3 divisioni in elica, prima placchetta positiva traente con il resto delle placchette negative. Forante in diamante, angolo assiale da 20°+/- . Corpo in acciaio speciale. Ottima per lavorazione di pannelli in truciolare rivestito, MDF rivestito, laminati, nobilitati e legni duri senza nodi.

PCD shank cutter Z3+3 with PCD tips H4,5 mm resharpened up to 8 times three helicoidal wing, first tip positive all the others negative, plunge tip in PCD, cutting angle 20° steel body. Suitable for working on chipboard panels, laminated, solid wood and MDF.



DIMENSIONI DIMENSIONS						ARTICOLI ITEMS				PREZZI €
D	LU	DS	LS	LT	β°	Z TOT	Z EFF	SX / LH	DX / RH	PRICE €
DIAMETER	USEFUL LENGHT	SHANK DIAMETER	SHANK LENGTH	TOT. LENGTH	AXIAL ANGLE	TOT. TEETH	ACTUAL TEETH	CODICE / SKU	CODICE / SKU	
18	25	20	50	85	20°	11	3+3	FPD2024019	FPD2024020	
18	30	20	50	90	20°	14	3+3	FPD2024023	FPD2024024	
20	25	20	50	85	20°	11	3+3	FPD2024035	FPD2024036	
20	30	20	50	90	20°	14	3+3	FPD2024039	FPD2024040	
20	35	20	50	95	20°	17	3+3	FPD2024043	FPD2024044	
20	45	20	50	105	20°	23	3+3	FPD2024051	FPD2024052	
22	35	20	50	95	22°	17	3+3	FPD2024063	FPD2024064	
22	45	20	50	105	22°	23	3+3	FPD2024071	FPD2024072	
25	30	25	55	95	25°	14	3+3	FPD2024081	FPD2024082	
25	45	25	55	110	25°	23	3+3	FPD2024087	FPD2024088	
25	50	25	55	115	25°	26	3+3	FPD2024089	FPD2024090	
25	55	20	50	115	25°	29	3+3	FPD2024097	FPD2024098	

ULTRACUT 2 ULC FPD2025

FRESA ELICOIDALE IN DIAMANTE Z3+3 CORPO IN ACCIAIO PCD H4,5 MM

PCD HELICOIDAL SHANK CUTTER Z3+3 STEEL BODY PCD H4,5 MM

Fresa in diamante Z3+3, con placchetta riaffilabile H4,5 mm (max 8 riaffilature), 3 divisioni in elica, assialità della fresa prevalentemente positiva per un ottima estrazione del truciolare verso l'attacco. Forante in diamante, angolo assiale da 20°+/- . Corpo in acciaio speciale. Ottima per lavorazione di pannelli in truciolare rivestito, MDF rivestito.

PCD shank cutter Z3+3 with PCD tips H4,5 mm resharpened up to 8 times three helicoidal wing, tip mainly positive for better evaquaton of wooden chips, plunge tip in PCD, cutting angle 20° steel body. Suitable for working on chipboard panels, laminated and MDF.

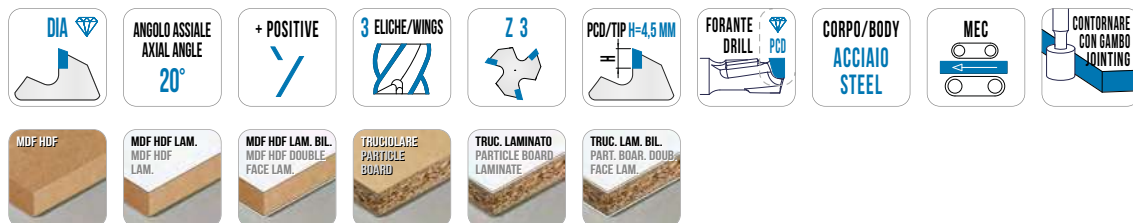
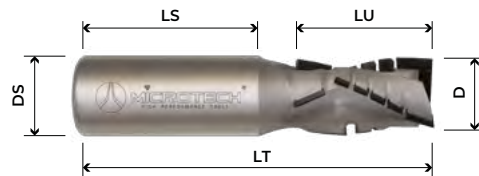

DIMENSIONI DIMENSIONS						ARTICOLI ITEMS				PREZZI €
D	LU	DS	LS	LT	β°	Z TOT	Z EFF	SX / LH	DX / RH	PRICE €
DIAMETER	USEFUL LENGHT	SHANK DIAMETER	SHANK LENGTH	TOT. LENGTH	AXIAL ANGLE	TOT. TEETH	ACTUAL TEETH	CODICE / SKU	CODICE / SKU	
20	25	20	50	85	20°	9	3+3	FPD2025001	FPD2025002	
20	30	20	50	90	20°	12	3+3	FPD2025005	FPD2025006	
20	35	20	50	95	20°	15	3+3	FPD2025009	FPD2025010	
20	45	20	50	105	20°	25	3+3	FPD2025017	FPD2025018	
22	35	20	50	95	22°	15	3+3	FPD2025029	FPD2025030	
22	45	20	50	105	22°	21	3+3	FPD2025037	FPD2025038	
25	30	25	55	95	25°	12	3+3	FPD2025043	FPD2025044	
25	45	25	55	110	25°	21	3+3	FPD2025049	FPD2025050	
25	50	25	55	115	25°	24	3+3	FPD2025051	FPD2025052	
25	55	25	55	120	25°	27	3+3	FPD2025053	FPD2025054	

STARCUT 1 RX4 FPD2028

FRESA ELICOIDALE IN DIAMANTE Z2+2 ASSIALE 30°
CORPO IN ACCIAIO PCD H4,5 MM

PCD HELICOIDAL SHANK CUTTER Z2+2 CUTTING ANGLE 30°
STEEL BODY PCD H4,5 MM

Fresa in diamante Z2+2, con placchetta riaffilabile H4,5mm (max 8 riaffilature), 4 divisioni in elica, prima placchetta positiva traente con il resto delle placchette negative. Forante in diamante, corpo in acciaio speciale, angolo assiale da 30° per ottenere ottime finiture sul pannello. Ottima per lavorazione di pannelli in trucolare rivestito, MDF rivestito, multistrato rivestito, legni duri senza nodi.

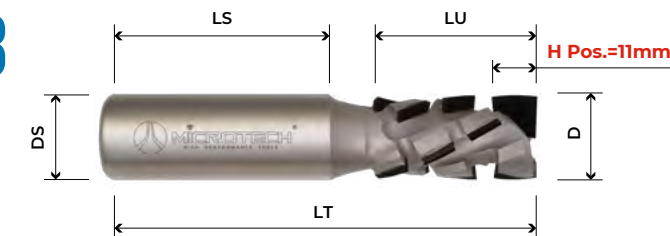

PCD shank cutter Z2+2 with PCD tips H4,5 mm resharpened up to 8 times four helicoidal wing, first tip positive all the others negative, plunge tip in PCD, cutting angle 30° steel body. Suitable for working on chipboard panels, plywood, laminated, solid wood and MDF.



DIMENSIONI DIMENSIONS						ARTICOLI ITEMS		PREZZI €			
D	LU	DS	LS	LT	β°	H	Z TOT	Z EFF	SX / LH	DX / RH	PRICE €
DIAMETER	USEFUL LENGHT	SHANK DIAMETER	SHANK LENGTH	TOT. LENGTH	AXIAL ANGLE	POS	TOT. TEETH	ACTUAL TEETH	CODICE / SKU	CODICE / SKU	
16	26	16	50	85	30°	11	9	2+2	FPD2028079	FPD2028080	
16	31	16	50	91	30°	11	11	2+2	FPD2028081	FPD2028082	
16	36	16	50	96	30°	11	13	2+2	FPD2028083	FPD2028084	
18	26	20	50	85	30°	11	9	2+2	FPD2028001	FPD2028002	
20	26	20	50	85	30°	11	9	2+2	FPD2028009	FPD2028010	
20	31	20	50	91	30°	11	11	2+2	FPD2028013	FPD2028014	
20	36	20	50	96	30°	11	13	2+2	FPD2028017	FPD2028018	
20	43	20	50	101	30°	11	15	2+2	FPD2028021	FPD2028022	
20	47	20	50	107	30°	11	17	2+2	FPD2028025	FPD2028026	
22	26	20	50	85	30°	11	9	2+2	FPD2028029	FPD2028030	
22	36	20	50	96	30°	11	13	2+2	FPD2028037	FPD2028038	
22	43	20	50	101	30°	11	15	2+2	FPD2028041	FPD2028042	
22	47	20	50	107	30°	11	17	2+2	FPD2028045	FPD2028046	
22	57	20	50	117	30°	11	21	2+2	FPD2028053	FPD2028054	
25	26	25	55	90	30°	11	9	2+2	FPD2028061	FPD2028062	
25	31	25	55	96	30°	11	11	2+2	FPD2028063	FPD2028064	
25	36	25	55	101	30°	11	13	2+2	FPD2028065	FPD2028066	
25	43	25	55	106	30°	11	15	2+2	FPD2028067	FPD2028068	
25	47	25	55	112	30°	11	17	2+2	FPD2028069	FPD2028070	
25	52	25	55	117	30°	11	19	2+2	FPD2028071	FPD2028072	
25	57	25	55	122	30°	11	21	2+2	FPD2028073	FPD2028074	
25	63	25	55	128	30°	11	23	2+2	FPD2028075	FPD2028076	
25	68	25	55	133	30°	11	25	2+2	FPD2028077	FPD2028078	
25	72	25	55	133	30°	11	27	2+2	FPD2028085	FPD2028086	
25	84	25	55	133	30°	11	31	2+2	FPD2028087	FPD2028088	

STARCUT 2 RX4 FPD2057

FRESA ELICOIDALE IN DIAMANTE Z2+2 ASSIALE 30° CORPO IN ACCIAIO
PCD H4,5 CON PRIMO PCD POSITIVO DI 5MM PER PANNELLI DI BASSO SPESSORE

PCD HELICOIDAL SHANK CUTTER Z2+2 CUTTING ANGLE 30° STEEL BODY
PCD H4,5 MM FIRST PCD TIP POSITIVE 5 MM FOR SMALL THICKNESS

Fresa in diamante Z2+2, con placchetta riaffilabile H4,5mm (max 8 riaffilature), 4 divisioni in elica, prima placchetta positiva traente con il resto delle placchette negative. Forante in diamante, corpo in acciaio speciale, angolo assiale da 30° per ottenere ottime finiture sul pannello. Ottima per lavorazione di pannelli in truciolare rivestito, MDF rivestito, multistrato rivestito, legni duri senza nodi.

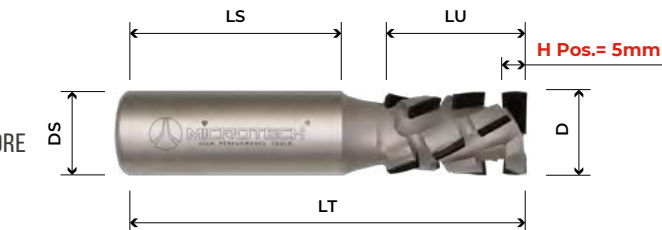

PCD shank cutter Z2+2 with PCD tips H4,5 mm resharpened up to 8 times four helicoidal wing, first tip positive all the others negative, plunge tip in PCD, cutting angle 30° steel body. Suitable for working on chipboard panels, plywood, laminated, solid wood and MDF.



DIMENSIONI DIMENSIONS							ARTICOLI ITEMS				PREZZI €
D	LU	DS	LS	LT	β°	H	Z TOT	Z EFF	SX / LH	DX / RH	PRICE €
DIAMETER	USEFUL LENGHT	SHANK DIAM.	SHANK LENGTH	TOT. LENGTH	AXIAL ANGLE	POS	TOT. TEETH	ACTUAL TEETH	CODICE / SKU	CODICE / SKU	
18	26	20	50	85	30°	5	11	2+2	FPD2057003	FPD2057004	
20	26	20	50	85	30°	5	11	2+2	FPD2057001	FPD2057002	
20	36	20	50	85	30°	5	14	2+2	FPD2057005	FPD2057006	
20	46	20	50	85	30°	5	18	2+2	FPD2057007	FPD2057008	

STARCUT 3 RX4C FPD2029

FRESA ELICOIDALE IN DIAMANTE Z2+2 ASSIALE 30°
CORPO IN ACCIAIO PCD H4,5 MM

PCD HELICOIDAL SHANK CUTTER Z2+2 CUTTING ANGLE 30°
STEEL BODY PCD H4,5 MM

Fresa in diamante Z2+2, con placchetta riaffilabile H4,5 mm (max 8 riaffilature), 4 divisioni in elica, assilità dei taglianti prevalentemente positiva per favorire l'estrazione de truciolo verso l'attacco. Forante in diamante, corpo in acciaio speciale, angolo assiale da 30° per ottenere ottime finiture sul pannello. Ottima per lavorazione di pannelli in truciolare rivestito, MDF rivestito, multistrato rivestito e legni duri senza nodi.

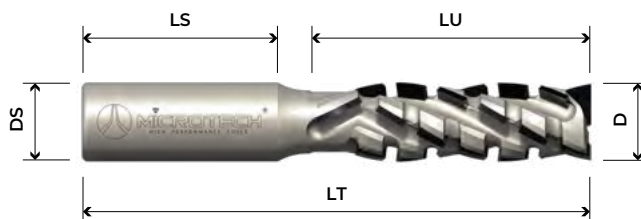

PCD shank cutter Z2+2 with PCD tips H4,5 mm resharpened up to 8 times four helicoidal wing, tip mainly positive for better evaquaton of wooden chips, plunge tip in PCD, cutting angle 30° steel body. Suitable for working on chipboard panels, plywood, laminated, solid wood and MDF.



DIMENSIONI DIMENSIONS							ARTICOLI ITEMS				PREZZI €
D	LU	DS	LS	LT	β°	Z TOT	Z EFF	SX / LH	DX / RH	PRICE €	
DIAMETER	USEFUL LENGHT	SHANK DIAMETER	SHANK LENGTH	TOT. LENGTH	AXIAL ANGLE	TOT. TEETH	ACTUAL TEETH	CODICE / SKU	CODICE / SKU		
20	25	20	50	85	30°	9	2+2	FPD2029009	FPD2029010		
20	31	20	50	91	30°	11	2+2	FPD2029013	FPD2029014		
20	36	20	50	96	30°	13	2+2	FPD2029017	FPD2029018		
20	41	20	50	101	30°	15	2+2	FPD2029021	FPD2029022		
20	47	20	50	107	30°	17	2+2	FPD2029025	FPD2029026		
22	25	20	50	85	30°	9	2+2	FPD2029029	FPD2029030		
22	36	20	50	96	30°	13	2+2	FPD2029037	FPD2029038		
22	47	20	50	107	30°	17	2+2	FPD2029045	FPD2029046		
22	52	20	50	112	30°	19	2+2	FPD2029049	FPD2029050		
25	36	25	55	101	30°	13	2+2	FPD2029061	FPD2029062		
25	41	25	55	106	30°	15	2+2	FPD2029063	FPD2029064		
25	47	25	55	112	30°	17	2+2	FPD2029065	FPD2029066		
25	52	25	55	117	30°	19	2+2	FPD2029067	FPD2029068		
25	57	25	55	122	30°	21	2+2	FPD2029069	FPD2029070		
25	63	25	55	128	30°	23	2+2	FPD2029071	FPD2029072		
25	68	25	55	133	30°	25	2+2	FPD2029073	FPD2029074		

STARCUT 4 RX4S FPD2033

FRESA ELICOIDALE IN DIAMANTE Z2+2 ASSIALE 45°
CORPO IN ACCIAIO PCD H4,5 MM

PCD HELICOIDAL SHANK CUTTER Z2+2 CUTTING ANGLE 45°
STEEL BODY PCD H4,5 MM

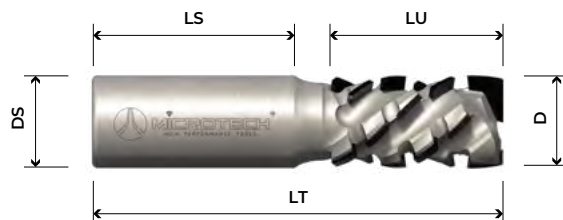

Fresa in diamante Z2+2, con placchetta riaffilabile H4,5 mm (max 8 riaffilature), 4 divisioni in elica, prima placchetta positiva traente con il resto delle placchette negative.

Forante in diamante, corpo in acciaio speciale, angolo assiale da 45° per ottenere ottime finiture sul pannello.

Ottima per lavorazione di pannelli in truciolare rivestito, MDF rivestito, multistrato rivestito e legni duri senza nodi.

PCD shank cutter Z2+2 with PCD tips H4,5 mm resharpened up to 8 times four helicoidal wing, first tip positive all the others negative, plunge tip in PCD, cutting angle 45° steel body.

Suitable for working on chipboard panels, plywood, laminated, solid wood and MDF.

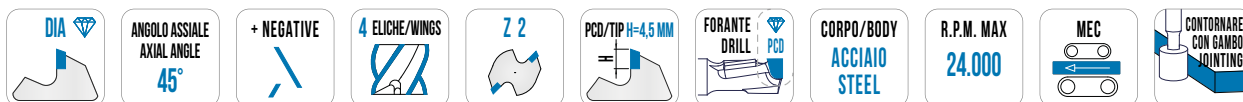

DIMENSIONI DIMENSIONS							ARTICOLI ITEMS		PREZZI €	
D	LU	DS	LS	LT	β°	Z TOT	Z EFF	SX / LH	DX / RH	PRICE €
DIAMETER	USEFUL LENGTH	SHANK DIAMETER	SHANK LENGTH	TOT. LENGTH	AXIAL ANGLE	TOT. TEETH	ACTUAL TEETH	CODICE / SKU	CODICE / SKU	
20	26	20	50	86	45°	11	2+2	FPD2033005	FPD2033006	
20	35	20	50	95	45°	15	2+2	FPD2033009	FPD2033010	
20	44	20	50	104	45°	19	2+2	FPD2033013	FPD2033014	
22	26	20	50	86	45°	11	2+2	FPD2033021	FPD2033022	
22	35	20	50	95	45°	15	2+2	FPD2033025	FPD2033026	
22	44	20	50	104	45°	19	2+2	FPD2033029	FPD2033030	
22	53	20	50	113	45°	23	2+2	FPD2033033	FPD2033034	
25	26	25	55	91	45°	11	2+2	FPD2033039	FPD2033040	
25	35	25	55	100	45°	15	2+2	FPD2033041	FPD2033042	
25	44	25	55	109	45°	19	2+2	FPD2033043	FPD2033044	
25	53	25	55	118	45°	23	2+2	FPD2033045	FPD2033046	
25	62	25	55	127	45°	27	2+2	FPD2033047	FPD2033048	
25	71	25	55	136	45°	31	2+2	FPD2033049	FPD2033050	

STARCUT 5 RX4SC FPD2034

FRESA ELICOIDALE IN DIAMANTE Z2+2 ASSIALE 45°
CORPO IN ACCIAIO PCD H4,5 MM

PCD HELICOIDAL SHANK CUTTER Z2+2 CUTTING ANGLE 45°
STEEL BODY PCD H4,5 MM

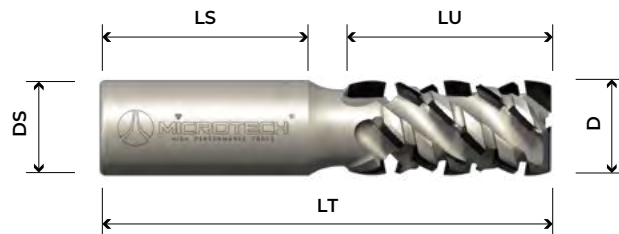

Fresa in diamante Z2+2, con placchetta riaffilabile H4,5mm (max 8 riaffilature), 4 divisioni in elica, assilità dei taglienti prevalentemente positiva per favorire l'estrazione de truciolo verso l'attacco. Forante in diamante, corpo in acciaio speciale, angolo assiale da 45° per ottenere ottime finiture sul pannello. Ottima per lavorazione di pannelli in truciolare rivestito, MDF rivestito, multistrato rivestito, legni duri senza nodi.

PCD shank cutter Z2+2 with PCD tips H4,5 mm reshaped up to 8 times four helicoidal wing, tip mainly positive for better evaquaton of wooden chips, plunge tip in PCD, cutting angle 30° steel body. Suitable for working on chipboard panels, plywood, laminated, solid wood and MDF.

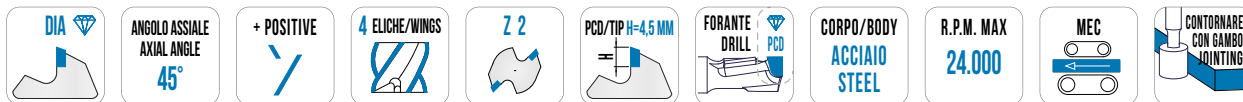

DIMENSIONI		DIMENSIONS		ARTICOLI		ITEMS		PREZZI €		
D	LU	DS	LS	LT	β°	Z TOT	Z EFF	SX / LH	DX / RH	PRICE €
DIAMETER	USEFUL LENGTH	SHANK DIAM.	SHANK LENGTH	TOT. LENGTH	AXIAL ANGLE	TOT. TEETH	ACTUAL TEETH	CODICE / SKU	CODICE / SKU	
20	17	20	50	77	45°	7	2+2	FPD2034001	FPD2034002	
20	17	25	55	82	45°	7	2+2	FPD2034003	FPD2034004	
20	26	20	50	86	45°	11	2+2	FPD2034005	FPD2034006	
20	26	25	55	91	45°	11	2+2	FPD2034007	FPD2034008	
20	35	20	50	95	45°	15	2+2	FPD2034009	FPD2034010	
20	35	25	55	100	45°	15	2+2	FPD2034011	FPD2034012	
20	44	20	50	104	45°	19	2+2	FPD2034013	FPD2034014	
20	44	25	55	109	45°	19	2+2	FPD2034015	FPD2034016	
22	17	20	50	77	45°	7	2+2	FPD2034017	FPD2034018	
22	17	25	55	82	45°	7	2+2	FPD2034019	FPD2034020	
22	26	20	50	86	45°	11	2+2	FPD2034021	FPD2034022	
22	26	25	55	91	45°	11	2+2	FPD2034023	FPD2034024	
22	35	20	50	95	45°	15	2+2	FPD2034025	FPD2034026	
22	35	25	55	100	45°	15	2+2	FPD2034027	FPD2034028	
22	44	20	50	104	45°	19	2+2	FPD2034029	FPD2034030	
22	44	25	55	109	45°	19	2+2	FPD2034031	FPD2034032	
22	53	20	50	113	45°	23	2+2	FPD2034033	FPD2034034	
22	53	25	55	118	45°	23	2+2	FPD2034035	FPD2034036	
25	17	25	55	82	45°	7	2+2	FPD2034037	FPD2034038	
25	26	25	55	91	45°	11	2+2	FPD2034039	FPD2034040	
25	35	25	55	100	45°	15	2+2	FPD2034041	FPD2034042	
25	44	25	55	109	45°	19	2+2	FPD2034043	FPD2034044	
25	53	25	55	118	45°	23	2+2	FPD2034045	FPD2034046	
25	62	25	55	127	45°	27	2+2	FPD2034047	FPD2034048	
25	71	25	55	136	45°	31	2+2	FPD2034049	FPD2034050	
25	80	25	55	145	45°	35	2+2	FPD2034051	FPD2034052	

STARCUT 8 FPD2064

NEW

FRESA ELICOIDALE IN DIAMANTE
ROMPITRUCIOLO Z2+2 ASSIALE 30°
CORPO IN METALLO PESANTE PCD H4,5

PCD HELICOIDAL CHIP BREAKER SHANK
CUTTER Z 2+2 AXIAL 30° HDM BODY

ROMPITRUCIOLO AFFILATO CON LASER
RIAFFILATURA CON MACCHINE
STANDARD
VOLLMER E WALTER

CHIP BRACKER SHARP WITH LASER
RESHARPENING WITH STANDARD
MACHINE
VOLLMER / WALTER

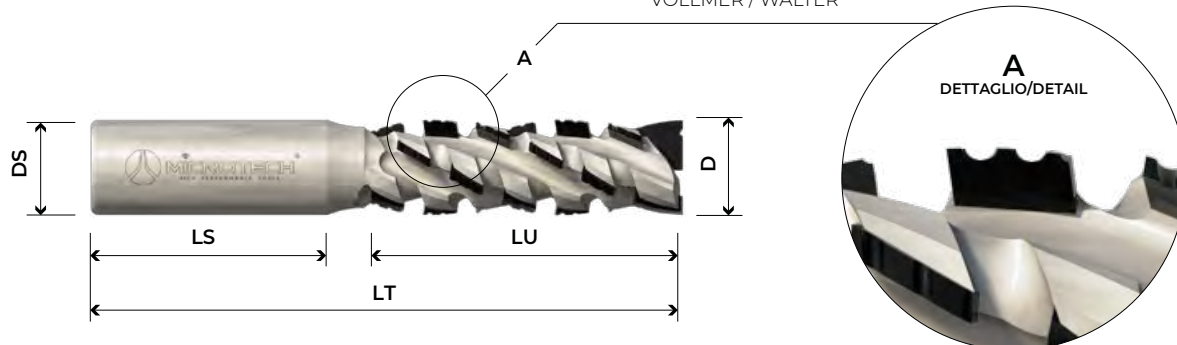

Fresa in diamante Z2+2, con placchetta riaffilabile, 4 divisioni in elica, tutta positiva con rompitrucilo eseguito al laser. Forante in diamante, corpo in metallo pesante, angolo assiale da 30°. Ottima per sgrossare pannelli di MDF rivestito, multistrato rivestito, legni duri senza nodi in sostituzione delle classiche frese rompitrucilo elicoidali.

PCD Shank cutter Z2+2, with resharpenable tips, 4 helix divisions, all positive with chip breaker made by laser machine. Diamond plung tip, heavy metal body, 30 ° axial angle. Excellent for roughing coated MDF panels, coated multilayer, hardwoods without knots to replace the classic helical chipbreaker cutters.



DIMENSIONI					DIMENSIONS			ARTICOLI		ITEMS	PREZZI €
D	LU	DS	LS	LT	β°	Z TOT	Z EFF	SX / LH	DX / RH		PRICE €
DIAMETER	USEFUL LENGHT	SHANK DIAM.	SHANK LENGTH	TOT. LENGTH	AXIAL ANGLE	TOT. TEETH	ACTUAL TEETH	CODICE / SKU	CODICE / SKU		
16	36	16	50	95	30°	13	2+2	FPD2064001	FPD2064002		
16	43	16	50	102	30°	17	2+2	FPD2064003	FPD2064004		
20	36	20	50	95	30°	13	2+2	FPD2064005	FPD2064006		
20	47	20	50	106	30°	17	2+2	FPD2064007	FPD2064008		
20	65	20	50	124	30°	23	2+2	FPD2064019	FPD2064020		
25	47	25	55	111	30°	17	2+2	FPD2064009	FPD2064010		
25	57	25	55	121	30°	21	2+2	FPD2064011	FPD2064012		
25	63	25	55	127	30°	23	2+2	FPD2064013	FPD2064014		
25	72	25	55	136	30°	27	2+2	FPD2064015	FPD2064016		
25	84	25	55	148	30°	31	2+2	FPD2064017	FPD2064018		

EXTREME 1 REX2 FPD2036

FRESA ELICOIDALE IN DIAMANTE Z2+2 ASSIALE 54,9°
CORPO IN ACCIAIO PCD H4,5 MM

PCD HELICOIDAL SHANK CUTTER Z2+2 CUTTING ANGLE 54,9°
STEEL BODY PCD H4,5 MM

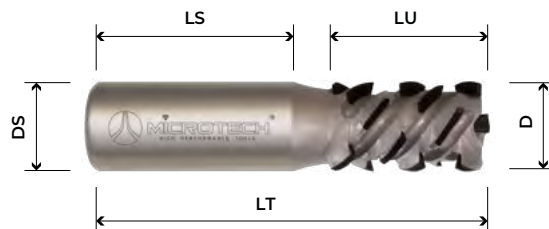

Fresa in diamante Z2+2 mm, con placchetta riaffilabile H4,5 mm (max 8 riaffilature), 4 divisioni in elica, prima placchetta positiva traente con il resto delle placchette negative.
Forante in diamante, corpo in acciaio speciale, angolo assiale da 54,9° per ottenere ottime finiture sul pannello.
Ottima per lavorazione di pannelli con rivestimento in carta, superfici verniciate, legni duri senza nodi lungo e controvena, truciolare rivestito, MDF rivestito e multistrato rivestito.

PCD shank cutter Z2+2 mm with PCD tips H4,5 mm resharpened up to 8 times four helicoidal wing, first tip positive all the others negative, plunge tip in PCD, cutting angle 54,9° steel body.
Suitable for working high-performance jointing and sizing of solid woods (free of knots) along and across the grain, jointing of melamine, paper, HPL laminated, foiled and veneered panels and lacquered surfaces, on chipboard, plywood, laminated and MDF.

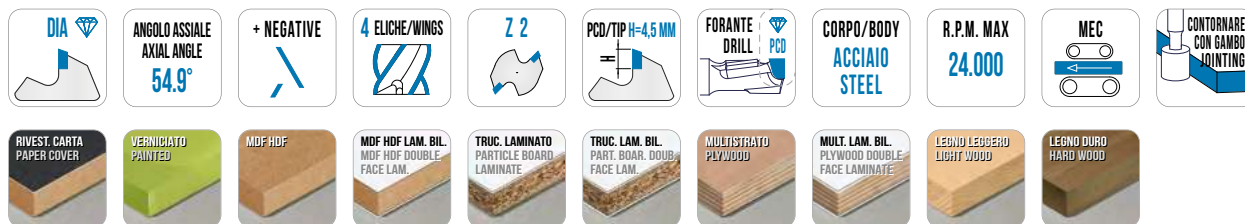

DIMENSIONI DIMENSIONS								ARTICOLI ITEMS		PREZZI €
D	LU	DS	LS	LT	β°	Z TOT	Z EFF	SX / LH	DX / RH	PRICE €
DIAMETER	USEFUL LENGTH	SHANK DIAM.	SHANK LENGTH	TOT. LENGTH	AXIAL ANGLE	TOT. TEETH	ACTUAL TEETH	CODICE / SKU	CODICE / SKU	
20	25	20	50	90	54,9°	11	2+2	FPD2036009	FPD2036010	
20	30	20	50	95	54,9°	13	2+2	FPD2036013	FPD2036014	
20	35	20	50	100	54,9°	15	2+2	FPD2036017	FPD2036018	
20	40	20	50	105	54,9°	17	2+2	FPD2036021	FPD2036022	
20	45	20	50	110	54,9°	19	2+2	FPD2036025	FPD2036026	
22	25	20	50	90	54,9°	11	2+2	FPD2036037	FPD2036038	
22	30	20	50	95	54,9°	13	2+2	FPD2036041	FPD2036042	
22	35	20	50	100	54,9°	15	2+2	FPD2036045	FPD2036046	
22	40	20	50	105	54,9°	17	2+2	FPD2036049	FPD2036050	
22	45	20	50	110	54,9°	19	2+2	FPD2036053	FPD2036054	
25	25	25	55	95	54,9°	11	2+2	FPD2036065	FPD2036066	
25	30	25	55	100	54,9°	13	2+2	FPD2036067	FPD2036068	
25	35	25	55	105	54,9°	15	2+2	FPD2036069	FPD2036070	
25	40	25	55	110	54,9°	17	2+2	FPD2036071	FPD2036072	
25	45	25	55	115	54,9°	19	2+2	FPD2036073	FPD2036074	
25	50	25	55	120	54,9°	21	2+2	FPD2036075	FPD2036076	
25	55	25	55	125	54,9°	23	2+2	FPD2036077	FPD2036078	
25	60	25	55	130	54,9°	25	2+2	FPD2036079	FPD2036080	
25	65	25	55	135	54,9°	27	2+2	FPD2036081	FPD2036082	

AIRCUT 1 RX6 FPD2030

FRESA ELICOIDALE IN DIAMANTE Z3+3 ASSIALE 30°
CORPO IN ACCIAIO PCD H4,5 MM

PCD HELICOIDAL SHANK CUTTER Z3+3 CUTTING ANGLE 30°
STEEL BODY PCD H4,5 MM

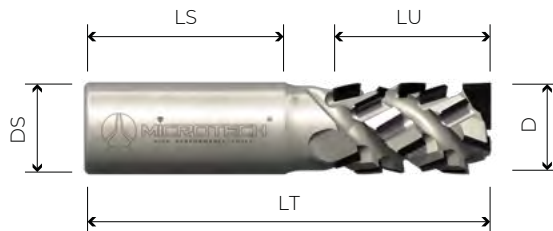

Fresa in diamante Z3+3, con placchetta riaffilabile H4,5 mm (max 8 riaffilature), 3 divisioni in elica, prima placchetta positiva traente con il resto delle placchette negative.

Forante in diamante, corpo in acciaio speciale, angolo assiale da 30° per ottenere ottime finiture sul pannello.

Ottima per lavorazione di pannelli in truciolare rivestito, MDF rivestito, multistrato rivestito e legni duri senza nodi.

PCD shank cutter Z3+3 with PCD tips H4,5 mm resharpened up to 8 times four helicoidal wing, first tip positive all the others negative, plunge tip in PCD, cutting angle 30° steel body.

Suitable for working on chipboard panels, plywood, laminated, solid wood and MDF.

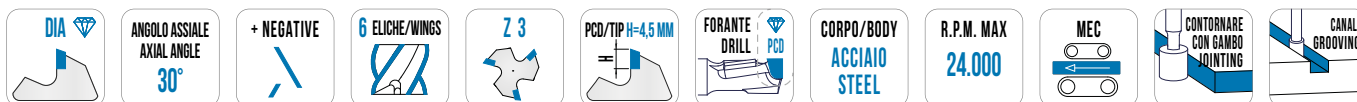

DIMENSIONI DIMENSIONS						ARTICOLI ITEMS				PREZZI €
D	LU	DS	LS	LT	β°	Z TOT	Z EFF	SX / LH	DX / RH	PRICE €
DIAMETER	USEFUL LENGTH	SHANK DIAM.	SHANK LENGTH	TOT. LENGTH	AXIAL ANGLE	TOT. TEETH	ACTUAL TEETH	CODICE / SKU	CODICE / SKU	
20	23	20	50	87	30°	12	3+3	FPD2030023	FPD2030024	
20	29	20	50	93	30°	15	3+3	FPD2030025	FPD2030026	
20	35	20	50	99	30°	18	3+3	FPD2030027	FPD2030028	
20	41	20	50	105	30°	21	3+3	FPD2030029	FPD2030030	
20	47	20	50	111	30°	24	3+3	FPD2030031	FPD2030032	
20	53	20	50	117	30°	27	3+3	FPD2030033	FPD2030034	
22	24	20	50	88	30°	12	3+3	FPD2030035	FPD2030036	
22	30	20	50	94	30°	15	3+3	FPD2030037	FPD2030038	
22	36	20	50	100	30°	18	3+3	FPD2030039	FPD2030040	
22	42	20	50	106	30°	21	3+3	FPD2030041	FPD2030042	
22	48	20	50	112	30°	24	3+3	FPD2030043	FPD2030044	
22	54	20	50	118	30°	27	3+3	FPD2030045	FPD2030046	
25	24	25	55	93	30°	12	3+3	FPD2030001	FPD2030002	
25	30	25	55	99	30°	15	3+3	FPD2030003	FPD2030004	
25	36	25	55	105	30°	18	3+3	FPD2030005	FPD2030006	
25	42	25	55	111	30°	21	3+3	FPD2030007	FPD2030008	
25	48	25	55	117	30°	24	3+3	FPD2030009	FPD2030010	
25	54	25	55	123	30°	27	3+3	FPD2030011	FPD2030012	
25	60	25	55	129	30°	30	3+3	FPD2030013	FPD2030014	
25	66	25	55	135	30°	33	3+3	FPD2030015	FPD2030016	
25	72	25	55	141	30°	36	3+3	FPD2030017	FPD2030018	
25	78	25	55	147	30°	39	3+3	FPD2030019	FPD2030020	
25	85	25	55	154	30°	42	3+3	FPD2030021	FPD2030022	

POWERCUT 5 FPD2040

FRESA ELICOIDALE IN DIAMANTE Z2+2 ASSIALE 25°
CORPO IN METALLO PESANTE PCD H3,5 MM

PCD HELICOIDAL SHANK CUTTER Z2+2 HDM BODY PCD H3,5 MM

Fresa PCD Z2+2 in metallo pesante e acciaio. Ottima per lavorazione di pannelli in truciolare rivestito, MDF rivestito, multistrato rivestito, legni duri senza nodi. Ideale per lavorazione nesting, angolo assiale 25°, 2 eliche, PCD H3,5 mm. Consigliata per lavorazione del multistrato grazie all'elevato canale di scarico.

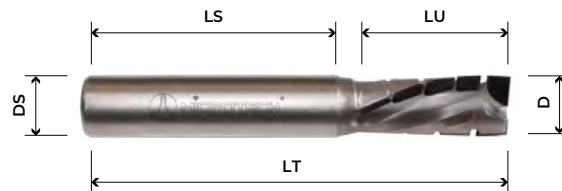

PCD shank cutter Z2+2 for nesting, with PCD tips H3,5 mm resharpened up to 3 times, two helicoidal wing, first tip positive all the others negative, plunge tip in PCD, cutting angle 25°, HDM (High density metal) and steel body.



CORPO METALLO PESANTE / HDM BODY

D		LU	DS	LS	LT	β°	H	Z TOT	Z EFF	H	SX / LH	DX / RH	PREZZI €
DIAM.	USEFUL LENGHT	SHANK DIAM.	SHANK LENGTH	TOT. LENGTH	AXIAL ANG.	POS	TOT. TEETH	ACT. TEETH	PAN	CODICE / SKU	CODICE / SKU	PRICE €	
8	18	10	40	65	25°	7,5	6	2+2	DA 10 A 15	FPD2040049	FPD2040050		
8	18	12	40	65	25°	7,5	6	2+2	DA 10 A 15	FPD2040043	FPD2040044		
8	22	10	40	70	25°	7,5	7	2+2	DA 10 A 19	FPD2040053	FPD2040054		
8	22	12	40	70	25°	7,5	7	2+2	DA 10 A 19	FPD2040045	FPD2040046		
10	18	10	40	65	25°	7,5	6	2+2	DA 10 A 15	FPD2040051	FPD2040052		
10	18	12	40	65	25°	7,5	6	2+2	DA 10 A 15	FPD2040025	FPD2040026		
10	22	12	40	70	25°	7,5	7	2+2	DA 15 A 19	FPD2040029	FPD2040030		
10	25	12	40	75	25°	7,5	8	2+2	DA 15 A 22	FPD2040031	FPD2040032		
10	28	12	40	75	25°	7,5	9	2+2	DA 18 A 25	FPD2040027	FPD2040028		
12	18	12	40	70	25°	7,5	6	2+2	DA 10 A 15	FPD2040001	FPD2040002		
12	25	12	40	70	25°	7,5	8	2+2	DA 12 A 22	FPD2040007	FPD2040008		
12	28	12	40	75	25°	7,5	9	2+2	DA 18 A 25	FPD2040013	FPD2040014		
12	34	12	40	80	25°	7,5	11	2+2	DA 25 A 30	FPD2040019	FPD2040020		
14	25	16	50	75	25°	7,5	8	2+2	DA 12 A 22	FPD2040035	FPD2040036		
14	34	16	50	90	25°	7,5	11	2+2	DA 25 A 30	FPD2040037	FPD2040038		
16	25	16	50	75	25°	7,5	8	2+2	DA 12 A 22	FPD2040039	FPD2040040		
16	34	16	50	90	25°	7,5	11	2+2	DA 25 A 30	FPD2040041	FPD2040042		
16	43	16	50	100	25°	7,5	13	2+2	DA 30 A 40	FPD2040047	FPD2040048		

POWERCUT 5A FPD2054

FRESA ELICOIDALE IN DIAMANTE Z2+2 ASSIALE 25°
CORPO IN ACCIAIO PCD H3,5 MM

PCD HELICOIDAL SHANK CUTTER Z2+2 CUTTING ANGLE 25°
STEEL BODY PCD H3,5 MM

Fresa in diamante Z2+2, corpo fresa in acciaio. Ottima per lavorazione di pannelli in truciolare rivestito, MDF rivestito, multistrato rivestito, legni duri senza nodi. Ideale per lavorazione nesting, angolo assiale 25°, 2 eliche, PCD H3,5 mm. Consigliata per lavorazione del multistrato grazie all'elevato canale di scarico.

PCD shank cutter Z2+2 for nesting, with PCD tips H3,5 mm resharpened up to 3 times, two helicoidal wing, first tip positive all the others negative, plunge tip in PCD, cutting angle 25°, steel body.

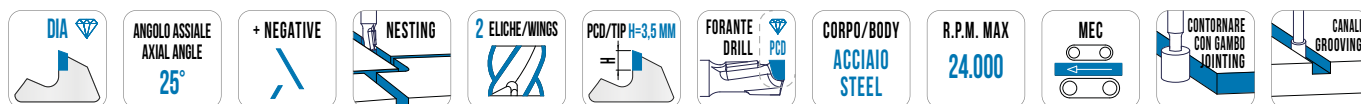
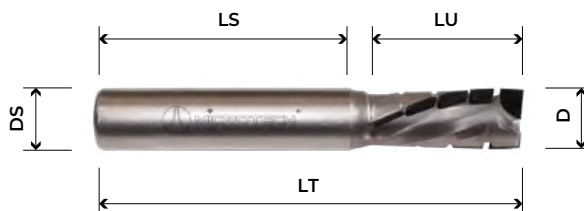

CORPO ACCIAIO / STEEL BODY

D		LU	DS	LS	LT	β°	Z TOT	H	SX / LH	DX / RH	PREZZI €
DIAMETER	USEFUL LENGHT	SHANK DIAMETER	SHANK LENGTH	TOT. LENGTH	AXIAL ANG.	TOT. TEETH	PAN	CODICE / SKU	CODICE / SKU	PRICE €	
10	18	12	40	64	25°	6	DA 10 A 15	FPD2054025	FPD2054026		
10	22	12	40	70	25°	7	DA 15 A 19	FPD2054021	FPD2054022		
12	18	12	40	64	25°	6	DA 10 A 15	FPD2054001	FPD2054002		
12	25	12	40	71	25°	8	DA 12 A 22	FPD2054007	FPD2054008		
12	28	12	40	74	25°	9	DA 18 A 25	FPD2054013	FPD2054014		
14	25	16	50	75	25°	8	DA 12 A 22	FPD2054023	FPD2054024		
14	34	16	50	90	25°	11	DA 25 A 30	FPD2054019	FPD2054020		
16	25	16	50	75	25°	8	DA 12 A 22	FPD2054027	FPD2054028		
16	34	16	50	90	25°	11	DA 25 A 30	FPD2054029	FPD2054030		

POWERCUT 4N FPD2041

FRESA NESTING ELICOIDALE IN DIAMANTE Z3+3
CORPO IN METALLO PESANTE

PCD HELICOIDAL SHANK CUTTER FOR NESTING Z3+3 HDM BODY

Fresa in diamante riaffilabile ad elica interrotta con tre divisioni, tre taglienti in presa, lato superiore ed inferiore, elica prevalentemente negativa, corpo in HDM, altezza PCD H3,5 mm. Adatta per lavorazioni di nesting, taglienti positivi/negativi, alta velocità di avanzamento, estrazione del truciolo, buona finitura e bassa rumorosità.

Re-sharpening shank cutter with split tips on three helicoidal wings, three engaged cutters on top and bottom parts, mainly negative helix, HDM body, PCD H3,5 mm. Tool suitable for nesting operation, cutters positive/negative, high working speed, good evacuation of chips, excellent finishing and low noise.

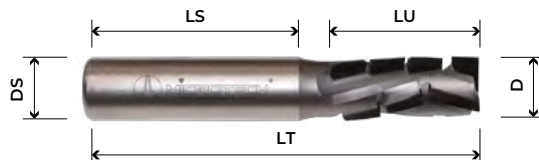

CORPO METALLO PESANTE / HDM BODY		DIMENSIONI DIMENSIONS		ARTICOLI ITEMS		PREZZI €						
D DIAM.	LU USEFUL LENGTH	DS SHANK DIAM.	LS SHANK LENGTH TOT.	LT LENGTH TOT.	β° AXIAL ANG.	Z TOT TOT. TEETH	H POS	H NEG	H PAN	SX / LH CODICE / SKU	DX / RH CODICE / SKU	PRICE €
10	23	12	40	70	20°	9	9,6	13,4	DA 18 A 21	FPD2041041	FPD2041042	
12	21	12	40	70	20°	8	9,6	11,4	DA 16 A 18	FPD2041001	FPD2041002	
12	25	12	40	75	20°	10	9,6	15,4	DA 19 A 22	FPD2041007	FPD2041008	
12	27	12	40	75	20°	11	9,6	17,4	DA 19 A 25	FPD2041013	FPD2041014	
12	32	12	40	80	20°	13	9,6	22,4	DA 25 A 30	FPD2041019	FPD2041020	
14	27	16	50	85	20°	11	9,6	17,4	DA 19 A 25	FPD2041025	FPD2041026	
14	32	16	50	90	20°	13	9,6	22,4	DA 19 A 30	FPD2041029	FPD2041030	
16	27	16	50	85	20°	11	9,6	17,4	DA 19 A 25	FPD2041039	FPD2041040	
16	37	16	50	100	20°	15	9,6	27,4	DA 19 A 35	FPD2041033	FPD2041034	
16	45	16	50	108	20°	19	10,6	34,4	DA 30 A 40	FPD2041037	FPD2041038	

POWERCUT 4NA FPD2058

FRESA NESTING ELICOIDALE IN DIAMANTE Z3+3 CORPO IN ACCIAIO

PCD HELICOIDAL SHANK CUTTER FOR NESTING Z3+3 STEEL BODY

Fresa in diamante riaffilabile ad elica interrotta con tre divisioni, tre taglienti in presa, lato superiore ed inferiore, elica prevalentemente negativa, corpo in ACCIAIO, altezza PCD H3,5 mm. Adatta per lavorazioni di nesting, taglienti positivi/negativi, alta velocità di avanzamento, estrazione del truciolo, buona finitura e bassa rumorosità.

Re-sharpening shank cutter with split tips on three helicoidal wings, three engaged cutters on top and bottom parts, mainly negative helix, STEEL body, PCD H3,5 mm. Tool suitable for nesting operation, cutters positive/negative, high working speed, good evacuation of chips, excellent finishing and low noise.

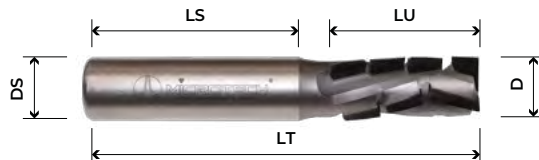

CORPO ACCIAIO / STEEL BODY		DIMENSIONI DIMENSIONS		ARTICOLI ITEMS		PREZZI €						
D DIAM.	LU USEFUL LENGTH	DS SHANK DIAM.	LS SHANK LENGTH TOT.	LT LENGTH TOT.	β° AXIAL ANG.	Z TOT TOT. TEETH	H POS	H NEG	H PAN	SX / LH CODICE / SKU	DX / RH CODICE / SKU	PRICE €
12	21	12	40	70	20°	8	9,6	11,4	DA 16 A 18	FPD2058001	FPD2058002	
12	25	12	40	75	20°	10	9,6	15,4	DA 19 A 22	FPD2058007	FPD2058008	
14	27	16	50	85	20°	11	9,6	17,4	DA 19 A 25	FPD2058025	FPD2058026	
14	27	20	50	85	20°	11	9,6	17,4	DA 19 A 25	FPD2058027	FPD2058028	
14	32	16	50	90	20°	13	9,6	22,4	DA 19 A 30	FPD2058029	FPD2058030	
14	32	20	50	90	20°	13	9,6	22,4	DA 19 A 30	FPD2058031	FPD2058032	
16	27	16	50	85	20°	11	9,6	17,4	DA 19 A 25	FPD2058033	FPD2058034	
16	37	16	50	90	20°	15	9,6	27,4	DA 19 A 35	FPD2058035	FPD2058036	
16	37	20	50	90	20°	15	9,6	27,4	DA 19 A 35	FPD2058037	FPD2058038	
20	27	20	50	85	20°	11	9,6	17,4	DA 19 A 25	FPD2058041	FPD2058042	
20	37	20	50	90	20°	15	9,6	27,4	DA 19 A 35	FPD2058043	FPD2058044	
20	45	20	50	108	20°	19	10,6	34,4	DA 30 A 40	FPD2058045	FPD2058046	

POWERCUT 4P FPD2042

FRESA NESTING ELICOIDALE IN DIAMANTE Z3+3, CORPO IN METALLO PESANTE
PCD HELICOIDAL SHANK CUTTER FOR NESTING Z3+3 PCD H3,5 MM, HDM BODY

Fresa in diamante riaffilabile ad elica interrotta con tre divisioni, tre taglienti in presa, lato superiore ed inferiore, elica prevalentemente positiva, corpo in HDM, altezza PCD H3,5 mm. Adatta per lavorazioni di nesting, taglienti positivi/negativi, alta velocità di avanzamento, estrazione del truciolo, buona finitura e bassa rumorosità.

Re-sharpening shank cutter with split tips on three helicoidal wings, three engaged cutters on top and bottom parts, mainly positive helix, HDM (High density metal) body, PCD H3,5 mm. Tool suitable for nesting, cutters positive/negative, high working speed, good evacuation of chips, excellent finishing and low noise.

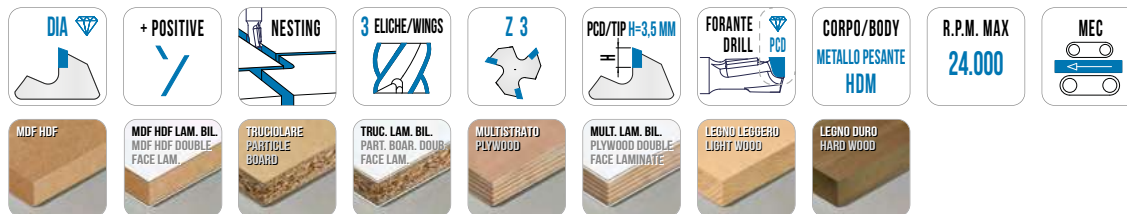
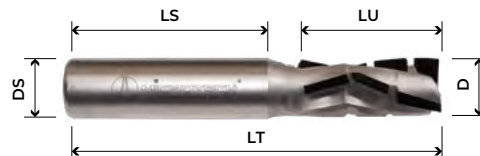

DIMENSIONI DIMENSIONS							ARTICOLI ITEMS		PREZZI €	
D	LU	DS	LS	LT	β°	Z TOT	H	SX / LH	DX / RH	PRICE €
DIAM.	USEFUL LENGTH	SHANK DIAM.	SHANK LENGTH	TOT. LENGTH	AXIAL ANG.	TOT. TEETH	PAN	CODICE / SKU	CODICE / SKU	
12	21	12	40	69	20°	8	DA 18 A 19	FPD2042023	FPD2042024	
12	27	12	40	75	20°	10	DA 22 A 25	FPD2042001	FPD2042002	
12	35	12	40	83	20°	13	DA 30	FPD2042007	FPD2042008	
16	27	16	50	85	20°	10	DA 22 A 25	FPD2042013	FPD2042014	
16	35	16	50	93	20°	13	DA 30	FPD2042017	FPD2042018	

POWERCUT 8N FPD2059

FRESA NESTING ELICOIDALE IN DIAMANTE Z2+2 CORPO IN METALLO PESANTE
PCD HELICOIDAL SHANK CUTTER FOR NESTING Z2+2 HDM BODY

Fresa in diamante riaffilabile ad elica interrotta con quattro divisioni, due taglienti in presa su tutti i livelli, elica prevalentemente negativa, altezza PCD 3,5 mm, corpo in metallo pesante HDM, adatta per lavorazioni di nesting su pannelli nobilitati, rivestiti, laminati, M.D.F. Taglienti positivi/negativi, altissima velocità di avanzamento, estrazione del truciolo, eccellente finitura, bassa rumorosità.

Re-sharpening shank cutter with split tips on six helicoidal wings, three engaged cutters on top and bottom parts, mainly negative helix, HDM (High density metal) body, PCD 3,5 mm. Tool suitable for nesting operation on chipboard panels laminate, coated or on MDF, OSB, cutters positive/negative, high working speed, good evacuation of chips, excellent finishing and low noise.

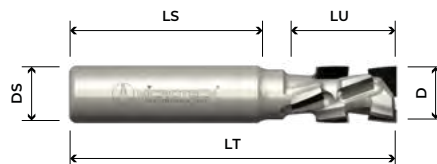

DIMENSIONI DIMENSIONS							ARTICOLI ITEMS		PREZZI €		
D	LU	DS	LS	LT	β°	H	Z TOT	H	SX / LH	DX / RH	PRICE €
DIAMETER	USEFUL LENGTH	SHANK DIAM.	SHANK LENGTH	TOT. LENGTH	AXIAL ANG.	POS	TOT. TEETH	PAN	CODICE / SKU	CODICE / SKU	
10	19	10	40	65	25°	7	6	DA 11 A 16	FPD2059047	FPD2059048	
10	19	12	40	65	25°	7	6	DA 11 A 16	FPD2059049	FPD2059050	
12	19	12	40	65	25°	7	6	DA 11 A 16	FPD2059009	FPD2059010	
12	22	12	40	70	25°	7	8	DA 11 A 19	FPD2059037	FPD2059038	
12	24	12	40	70	25°	7	8	DA 16 A 22	FPD2059017	FPD2059018	
12	29	12	40	75	25°	7	10	DA 24 A 26	FPD2059025	FPD2059026	
14	24	16	50	80	25°	7	8	DA 16 A 22	FPD2059039	FPD2059040	
14	29	16	50	85	25°	7	10	DA 24 A 26	FPD2059033	FPD2059034	
14	35	16	50	91	25°	7	12	DA 24 A 26	FPD2059035	FPD2059036	
16	24	16	50	80	25°	7	8	DA 16 A 22	FPD2059041	FPD2059042	
16	29	16	50	85	25°	7	10	DA 24 A 26	FPD2059043	FPD2059044	
16	35	16	50	91	25°	7	12	DA 24 A 26	FPD2059045	FPD2059046	

POWERCUT 6N FPD2043

FRESA NESTING ELICOIDALE IN DIAMANTE Z3+3 CORPO IN METALLO PESANTE, PREVALENTEMENTE NEGATIVA

PCD HELICOIDAL SHANK CUTTER FOR NESTING Z3+3 HDM (HIGH DENSITY METAL) BODY PCD H3,5 MM, MAINLY NEGATIVE

Fresa in diamante Z3 effettivi, corpo fresa in HDM (metallo pesante), angolo assiale prevalentemente negativo, 6 divisioni, placchetta H3,5 mm.

Ottima per lavorazione di pannelli in truciolare rivestito e MDF rivestito. Ideale per lavorazione nesting ad alte velocità di avanzamento.

Re-sharpening shank cutter with split tips on six helicoidal wings, three engaged cutters on top and bottom parts, mainly negative helix, HDM (High density metal) body, PCD 3,5 mm. Tool suitable for nesting operation on chipboard panels laminate, coated or on MDF, OSB, cutters positive/negative, high working speed, good evauation of chips, excellent finishing and low noise.

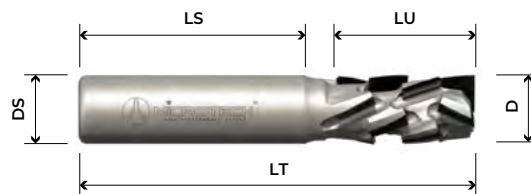

DIA	ANGOLO ASSIALE AXIAL ANGLE 25°	+ NEGATIVE	NESTING	6 ELICHE/WINGS	Z 3	PCD/TIP H=3,5 MM	FORANTE DRILL	CORPO/BODY METALLO PESANTE HDM	R.P.M. MAX 24.000
MDF HDF	MDF HDF LAM. BIL. MDF HDF DOUBLE FACE LAM.	TRUCIOLARE PARTICLE BOARD	TRUC. LAM. BIL. PART. BOAR. DOUB. FACE LAM.	MULTISTRATO PLYWOOD	MULT. LAM. BIL. PLYWOOD DOUBLE FACE LAMINATE				

DIMENSIONI		DIMENSIONS			ARTICOLI		ITEMS		PREZZI €			
D	LU	DS	LS	LT	β°	Z TOT	H POS	H NEG	H PAN	SX / LH CODICE / SKU	DX / RH CODICE / SKU	PRICE €
DIAM.	USEFUL LENGHT	SHANK DIAM.	SHANK LENGTH	TOT. LENGTH	AXIAL ANG.	TOT. TEETH						
12	19	12	40	65	25°	9	7	12	DA 11 A 16	FPD2043009	FPD2043010	
12	22	12	40	70	25°	12	7	15	DA 11 A 20	FPD2043037	FPD2043038	
12	24	12	40	70	25°	12	7	18	DA 16 A 22	FPD2043017	FPD2043018	
12	29	12	40	75	25°	15	7	23	DA 24 A 26	FPD2043025	FPD2043026	
14	24	16	50	80	25°	12	7	18	DA 16 A 22	FPD2043039	FPD2043040	
14	29	16	50	85	25°	15	7	28	DA 24 A 26	FPD2043033	FPD2043034	
14	35	16	50	91	25°	18	7	28	DA 24 A 26	FPD2043035	FPD2043036	
16	24	16	50	80	25°	12	7	18	DA 16 A 22	FPD2043041	FPD2043042	
16	29	16	50	85	25°	15	7	28	DA 24 A 26	FPD2043043	FPD2043044	
16	35	16	50	91	25°	18	7	28	DA 24 A 26	FPD2043045	FPD2043046	

STARCUT 6 RX4B FPD2048

FRESA ELICOIDALE DOPPIA ROTAZIONE IN DIAMANTE Z2+2
PCD HELICOIDAL SHANK CUTTERS Z2+2 DOUBLE ROTATION

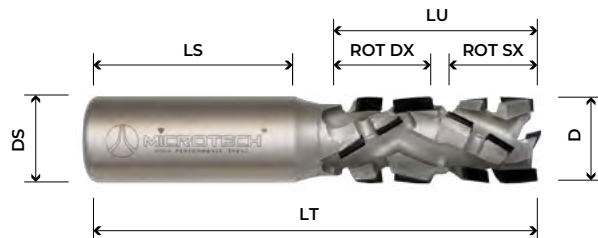

Fresa in diamante Z2+2 doppia rotazione DX/SX, con placchetta riaffilabile H4,5 mm (max 8 riaffilature), 4 divisioni in elica, prima placchetta positiva traente con il resto delle placchette negative. Forante in diamante, corpo in acciaio speciale, angolo assiale di 30° per ottenere ottime finiture sul pannello. Ottima per lavorazione di pannelli in truciolare rivestito, MDF rivestito e multistrato rivestito.

PCD helicoidal shank cutter Z2+2 double rotation LH/RH with PCD tips H4,5 mm resharpened up to 8 times, four helicoidal wing, first tip positive all the others negative, plunge tip in PCD steel body cutting angle 30°.

Suitable for working on laminated chipboard panels, plywood, laminated and laminated MDF.



DIMENSIONI DIMENSIONS							ARTICOLI ITEMS		PREZZI €	
D	LU	DS	LS	LT	β°	Z TOT	Z EFF	SX / LH	DX / RH	PRICE €
DIAMETER	USEFUL LENGHT	SHANK DIAMETER	SHANK LENGTH	TOT. LENGTH	AXIAL ANG.	TOTAL TEETH	ACTUAL TEETH	CODICE / SKU		
25	25+25	25	55	120	30°	17	2+2	FPD2048001		
25	31+31	25	55	132	30°	21	2+2	FPD2048002		
25	36+36	25	55	142	30°	25	2+2	FPD2048003		
25	41+41	25	55	152	30°	29	2+2	FPD2048004		
25	47+47	25	55	164	30°	33	2+2	FPD2048005		
25	52+52	25	55	174	30°	37	2+2	FPD2048006		
25	57+57	25	55	184	30°	41	2+2	FPD2048007		
25	63+63	25	55	196	30°	45	2+2	FPD2048008		
25	68+68	25	55	206	30°	49	2+2	FPD2048009		

ULTRACUT 3 ULB FPD2049

FRESA ELICOIDALE DOPPIA ROTAZIONE IN DIAMANTE Z3+3
PCD HELICOIDAL SHANK CUTTERS Z3+3 DOUBLE ROTATION

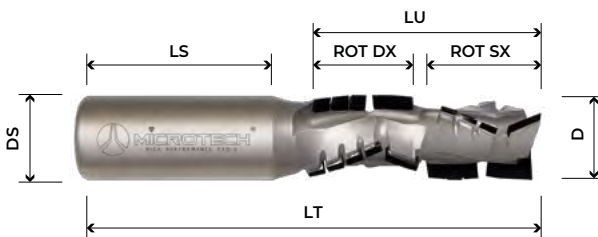

Fresa in diamante Z3+3 doppia rotazione DX/SX, con placchetta riaffilabile H4,5 mm (max 8 riaffilature), 3 divisioni in elica. Forante in diamante, angolo assiale da 20°+/- . Ottima per lavorazione di pannelli in truciolare rivestito e MDF rivestito.

PCD helicoidal shank cutter Z3+3 double rotation LH/RH with PCD tips H4,5 mm resharpened up to 8 times, three helicoidal wing, plunge tip in PCD steel body cutting angle 20°. Suitable for working on laminated chipboard panels and laminated MDF.

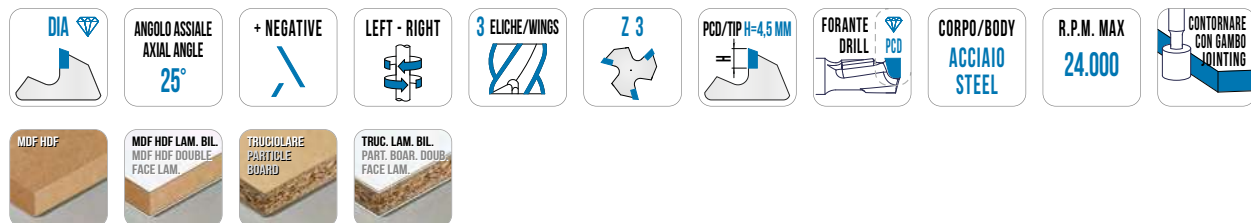

DIMENSIONI DIMENSIONS							ARTICOLI ITEMS		PREZZI €	
D	LU	DS	LS	LT	β°	Z TOT	Z EFF	SX / LH	DX / RH	PRICE €
DIAMETER	USEFUL LENGHT	SHANK DIAMETER	SHANK LENGTH	TOT. LENGTH	AXIAL ANG.	TOTAL TEETH	ACTUAL TEETH	CODICE / SKU		
25	30+30	25	55	95	25°	26		FPD2049001		
25	35+35	25	55	100	25°	32		FPD2049002		
25	40+40	25	55	105	25°	38		FPD2049003		
25	45+45	25	55	110	25°	44		FPD2049004		
25	50+50	25	55	115	25°	50		FPD2049005		
25	55+55	25	55	120	25°	56		FPD2049006		
25	62+62	25	55	127	25°	62		FPD2049007		
25	67+67	25	55	132	25°	68		FPD2049008		

STARCUT 7 TRPE FPD2050

FRESA DA RETTIFICA ELICOIDALE IN DIAMANTE
Z4+4 ASSIALE 40°

PCD RECTIFYING SHANK CUTTERS
Z4+4 CUTTING ANGLE 40°

Fresa in diamante Z4+4, con placchetta riaffilabile H4,5 mm (max 8 riaffilature), 8 divisioni in elica, assialità confluyente al centro, angolo assiale da 40° per ottenere ottime finiture sul pannello. Ideale per lavorazione di bordatura di pannelli in truciolare rivestito, MDF rivestito e multistrato rivestito.

PCD rectifying shank cutter Z4+4 with PCD tips H4,5 mm resharpened up to 8 times, eight helicoidal wing, cutting angle 40°. Suitable for working on laminated chipboard panels, laminated MDF and laminated plywood.

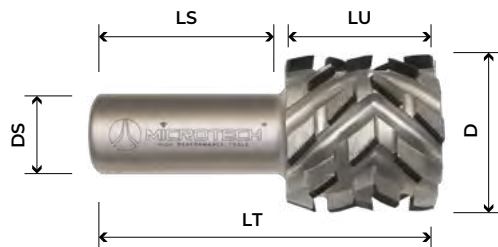

DIMENSIONI DIMENSIONS						ARTICOLI ITEMS		PREZZI €		
D	LU	DS	LS	LT	β°	Z TOT	Z EFF	SX / LH	DX / RH	PRICE €
DIAMETER	USEFUL LENGHT	SHANK DIAMETER	SHANK LENGTH	TOT. LENGTH	AXIAL ANG.	TOTAL TEETH	ACTUAL TEETH	CODICE / SKU	CODICE / SKU	
50	25	20	50	85	40°	16	4+4	FPD2050001	FPD2050002	
50	25	25	60	90	40°	16	4+4	FPD2050003	FPD2050004	
50	35	20	50	95	40°	24	4+4	FPD2050005	FPD2050006	
50	35	25	60	95	40°	24	4+4	FPD2050007	FPD2050008	
50	45	20	50	105	40°	28	4+4	FPD2050009	FPD2050010	
50	45	25	60	105	40°	28	4+4	FPD2050011	FPD2050012	
50	55	20	50	115	40°	40	4+4	FPD2050013	FPD2050014	
50	55	25	60	115	40°	40	4+4	FPD2050015	FPD2050016	
60	50	20	50	125	40°	32	4+4	FPD2050017	FPD2050018	
60	50	25	60	125	40°	32	4+4	FPD2050019	FPD2050020	

EXTREME 2 TRPX FPD2060

FRESA DA RETTIFICA ELICOIDALE
IN DIAMANTE Z3+3 ASSIALE 54,9°

PCD RECTIFY SHANK CUTTERS Z3+3
CUTTING ANGLE 54,9°

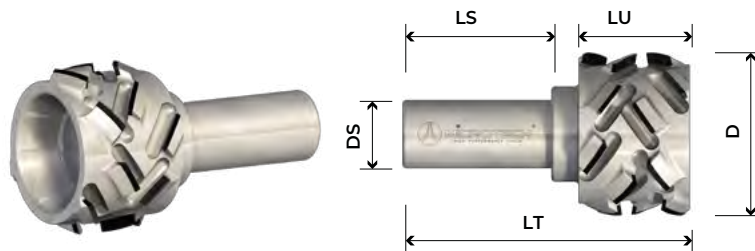

Fresa in diamante Z3+3, con placchetta riattivabile H4,5 mm (max 8 riaffilature), 6 divisioni in elica, angolo assiale da 54,9° per ottenere ottime finiture sul pannello.
Ideale per lavorazione di bordatura di pannelli in truciolare rivestito, MDF rivestito e multistrato rivestito.

PCD rectifying shank cutter Z3+3 with PCD tips H4,5 mm resharpened up to 6 times, cutting angle 54,9°. Suitable for working on laminated chipboard panels, laminated MDF and laminated plywood.



DIMENSIONI		DIMENSIONS		ARTICOLI		ITEMS		PREZZI €		
D	LU	DS	LS	LT	β°	Z TOT	Z EFF	SX / LH	DX / RH	PRICE €
DIAMETER	USEFUL LENGTH	SHANK DIAMETER	SHANK LENGTH	TOT. LENGTH	AXIAL ANG.	TOTAL TEETH	ACTUAL TEETH	CODICE / SKU	CODICE / SKU	
50	25	20	50	85	54,9	12	3+3	FPD2060001	FPD2060002	
50	25	25	60	90	54,9	12	3+3	FPD2060003	FPD2060004	
50	35	20	50	95	54,9	18	3+3	FPD2060005	FPD2060006	
50	35	25	60	100	54,9	18	3+3	FPD2060007	FPD2060008	
50	45	20	50	105	54,9	24	3+3	FPD2060009	FPD2060010	
50	45	25	60	110	54,9	24	3+3	FPD2060011	FPD2060012	
60	25	20	50	85	54,9	12	3+3	FPD2060013	FPD2060014	
60	25	25	60	90	54,9	12	3+3	FPD2060015	FPD2060016	
60	35	20	50	95	54,9	18	3+3	FPD2060017	FPD2060018	
60	35	25	60	100	54,9	18	3+3	FPD2060019	FPD2060020	
60	45	20	50	105	54,9	24	3+3	FPD2060021	FPD2060022	
60	45	25	60	110	54,9	24	3+3	FPD2060023	FPD2060024	
60	50	20	50	110	54,9	27	3+3	FPD2060025	FPD2060026	
60	50	25	60	115	54,9	27	3+3	FPD2060027	FPD2060028	
80	25	20	50	85	54,9	12	3+3	FPD2060029	FPD2060030	
80	25	25	60	90	54,9	12	3+3	FPD2060031	FPD2060032	
80	35	20	50	95	54,9	18	3+3	FPD2060033	FPD2060034	
80	35	25	60	100	54,9	18	3+3	FPD2060035	FPD2060036	
80	45	20	50	105	54,9	24	3+3	FPD2060037	FPD2060038	
80	45	25	60	110	54,9	24	3+3	FPD2060039	FPD2060040	
80	50	20	50	110	54,9	27	3+3	FPD2060041	FPD2060042	
80	50	25	60	115	54,9	27	3+3	FPD2060043	FPD2060044	

STARCUT 9 TAGLIENTE IN TESTA FPD2063

NEW

FRESA DA RETTIFICA ELICOIDALE
IN DIAMANTE PREVALENTEMENTE
NEGATIVA CON TAGLIANTE IN TESTA

PCD HELICOIDAL SHANK CUTTER
MAINLY NEGATIVE
AND TIP AT THE BOTTOM

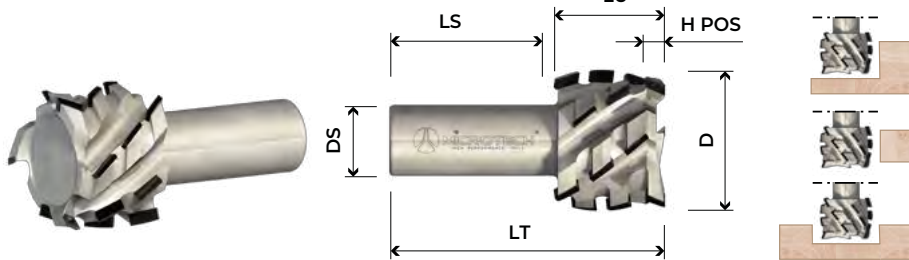

Fresa in diamante con placchetta riaffilabile H4,5mm (max 8 riaffilature), assialita' prevalentemente negativa ottima per fare battute e lavorare in spinatura grazie al tagliante in testa. Angolo assiale da 40°. Ideale anche per lavorazione di bordatura di pannelli in truciolare rivestito, MDF rivestito, multistrato rivestito.

Diamond shank cutter with H4.5mm resharpenable tips (max 8 regrindings), predominantly negative axiality excellent for making rebating thanks to the cutting edge tips at the bottom. 40 ° axial angle. Also ideal for rectifying the edges of coated chipboard panels, coated MDF, coated plywood.



D		LU		DS		LS		LT		β°		Z TOT		Z EFF		SX / LH		DX / RH		PREZZI €
DIAMETER		USEFUL LENGTH		SHANK DIAMETER		SHANK LENGTH		TOT. LENGTH		AXIAL ANG.		TOTAL TEETH		ACTUAL TEETH		CODICE / SKU		CODICE / SKU		PRICE €
50	25	20	50	85	40°	3+3	12	FPD2063001	FPD2063002											
50	25	25	55	90	40°	3+3	12	FPD2063003	FPD2063004											
50	38	20	50	98	40°	3+3	18	FPD2063005	FPD2063006											
50	38	25	55	103	40°	3+3	18	FPD2063007	FPD2063008											
50	50	20	50	110	40°	3+3	24	FPD2063009	FPD2063010											
50	50	25	55	115	40°	3+3	24	FPD2063011	FPD2063012											
60	25	20	50	85	40°	3+3	12	FPD2063013	FPD2063014											
60	25	25	55	90	40°	3+3	12	FPD2063015	FPD2063016											
60	38	20	50	98	40°	3+3	18	FPD2063017	FPD2063018											
60	38	25	55	103	40°	3+3	18	FPD2063019	FPD2063020											
60	50	20	50	110	40°	3+3	24	FPD2063021	FPD2063022											
60	50	25	55	115	40°	3+3	24	FPD2063023	FPD2063024											

SPACE 1 HW FPD2517

FRESA A COLTELLINI PER SPIANARE
E PER BATTUTE A COLTELLINI

INSERT KNIFE SHANK CUTTER
FOR PLANNING PANEL

Fresa a coltellini in HW per spianare piani in MDF e per fare battute.
Angolo assiale 0°.

Insert knife shank cutter for planning panel axial single 0.

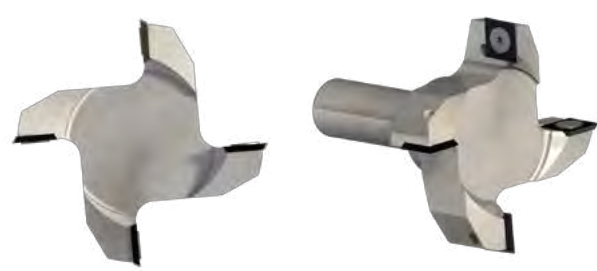
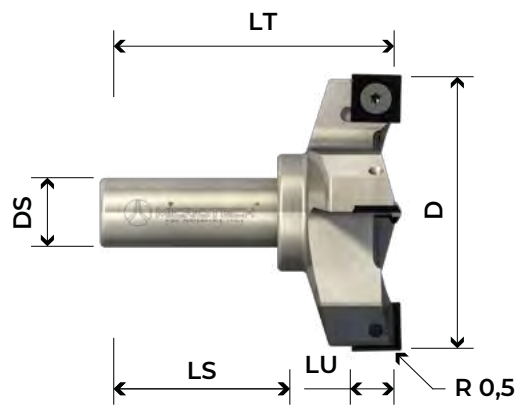
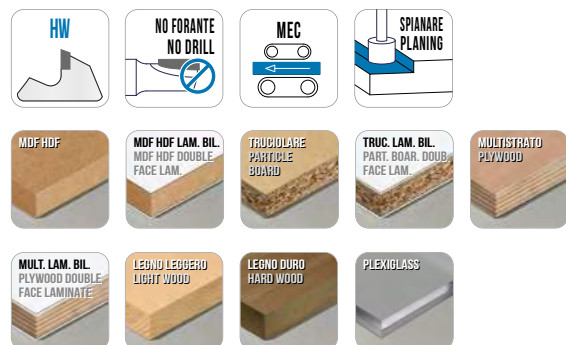

DIMENSIONI DIMENSIONS					ARTICOLI ITEMS		PREZZI €		
D	LU	DS	LS	LT	β°	R	Z EFF	DX / RH	PRICE €
DIAMETER	USEFUL LENGTH	SHANK DIAMETER	SHANK LENGTH	TOTAL LENGTH	AXIAL ANGLE	RADIUS	TOTAL TEETH	CODICE / SKU	
60	14	20	50	80	0°	0,5	4	FPD2517004	
80	14	20	50	80	0°	0,5	4	FPD2517005	
100	14	20	50	85	0°	0,5	4	FPD2517006	
100	14	20	50	85	0°	0,5	6	FPD2517007	

RICAMBI / PARTS

ARTICOLO ITEMS	COLTELLINO INSERTS	PREZZO € PRICE €	VITE INSERT SCREW	PREZZO € PRICE €	CHIAVE WRENCH	PREZZO € PRICE €
FPD2517004	RIC9008028		RIC9007057		RIC9013013	
FPD2517005	RIC9008028		RIC9007057		RIC9013013	
FPD2517006	RIC9008028		RIC9007057		RIC9013013	
FPD2517007	RIC9008028		RIC9007057		RIC9013013	

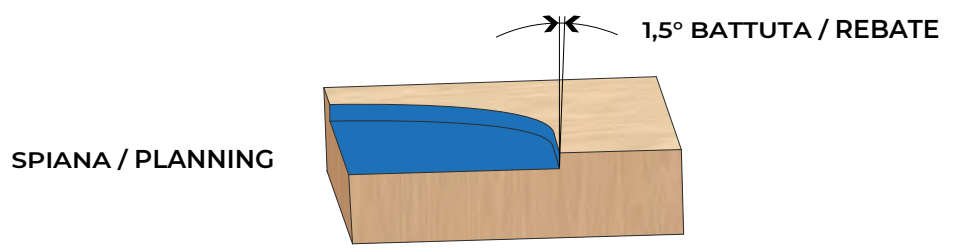
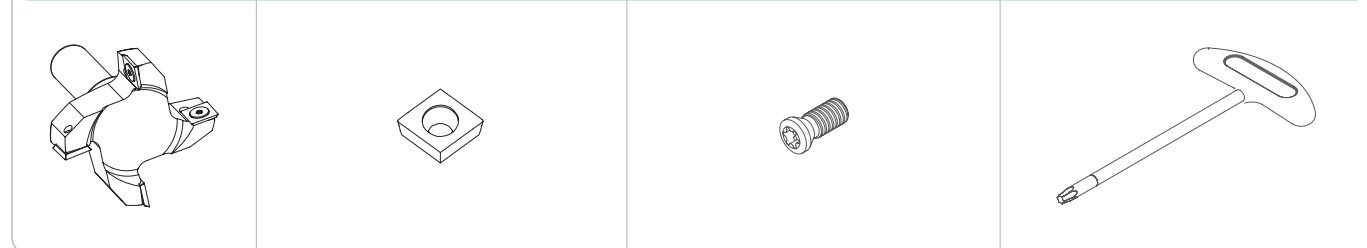

SPACE 2 FPD2056

FRESA IN DIAMANTE PER SPIANARE E PER BATTUTE - DIA FLY CUTTER

Fresa in diamante per spianare piani in MDF e per battute. Angolo assiale 0°, raggio 0,5 sullo spigolo laterale per evitare segni di spianatura.

Re-sharpening fly cutter in PCD, suitable to level out panel surfaces on CNC machines, to perform processing of nesting.

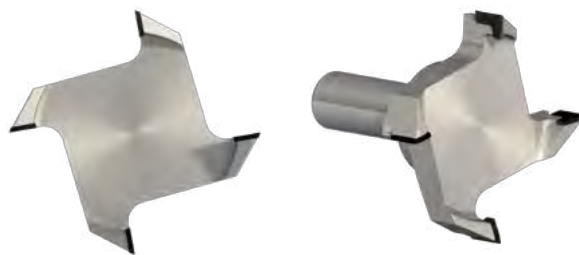
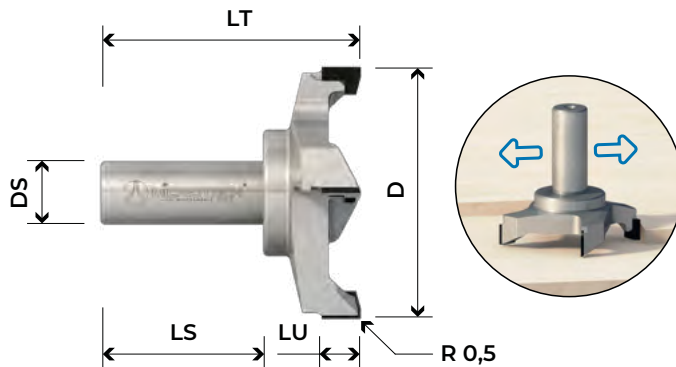

DIMENSIONI DIMENSIONS					ARTICOLI ITEMS		PREZZI €		
D	LU	DS	LS	LT	β°	R	Z TOT	DX / RH	PRICE €
DIAMETER	USEFUL LENGHT	SHANK DIAMETER	SHANK LENGTH	TOTAL LENGTH	AXIAL ANGLE	RADIUS	TOTAL TEETH	CODICE / SKU	
60	12	12	40	75	0°	0,5	3	FPD2056005	
60	12	20	50	80	0°	0,5	4	FPD2056001	
80	12	20	50	80	0°	0,5	4	FPD2056002	
100	12	20	50	85	0°	0,5	4	FPD2056003	
100	12	20	50	85	0°	0,5	6	FPD2056004	

SPACE 3 FPD2061

FRESA IN DIAMANTE PER SPIANARE, FORARE E PER BATTUTE

DIA FLY CUTTER

Fresa in diamante per spianare, forare piani in MDF e battute. Angolo assiale 0°, forante fino in centro, raggio 0,5 sullo spigolo laterale per evitare segni di spianatura.

Re-sharpening fly cutter in PCD, plunche tips, suitable to level out panel surfaces on CNC machines, to perform processing of nesting.

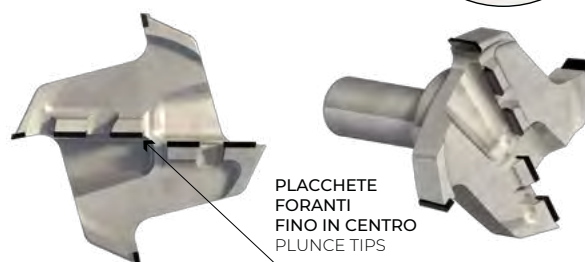
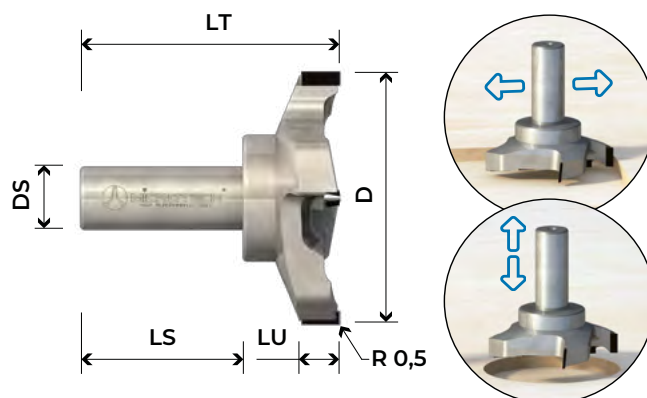
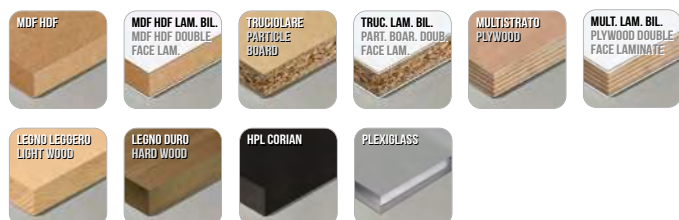

DIMENSIONI DIMENSIONS					ARTICOLI ITEMS		PREZZI €		
D	LU	DS	LS	LT	β°	R	Z TOT	DX / RH	PRICE €
DIAMETER	USEFUL LENGHT	SHANK DIAMETER	SHANK LENGTH	TOTAL LENGTH	AXIAL ANGLE	RADIUS	TOTAL TEETH	CODICE / SKU	
40	20	20	50	85	0°	0,5	7	FPD2061010	NEW
50	20	20	50	85	0°	0,5	7	FPD2061008	NEW
50	20	25	55	90	0°	0,5	7	FPD2061009	NEW
60	12	12	40	75	0°	0,5	6	FPD2061001	
60	12	20	50	80	0°	0,5	7	FPD2061002	
60	22	20	50	92	0°	0,5	7	FPD2061003	
80	12	20	50	80	0°	0,5	8	FPD2061004	
80	22	20	50	92	0°	0,5	8	FPD2061005	
100	12	20	50	85	0°	0,5	8	FPD2061006	
100	22	20	50	98	0°	0,5	8	FPD2061007	

AVANTECH 1 FRESA PER CAVE SERRATURE DI PORTE FPD2052

FRESA IN DIAMANTE Z2+2 PER CAVE
SERRATURE DI PORTE CORPO IN METALLO PESANTE

PCD HELICOIDAL SHANK CUTTERS Z2+2 FOR MACHINING
DOOR LOCKS
HDM (HIGH DENSITY METAL) BODY

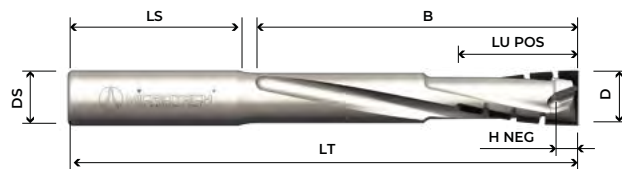

Fresa elica per cave di serrature porte, speciale geometria costruttiva, eccellente finitura nella parte esterna della piastrina e elevata capacità di asportazione all'interno della cava. Corpo in metallo pesante per ridurre notevolmente le vibrazioni aumentando la durata del tagliente, si raccomanda ingresso in interpolazione a rampa.

PCD helicoidal shank cutter Z2+2 for machining door locks with body anti-vibration in HDM (High density metal). The two negative tips give a good finishing during the operation for the slot the others two positive tips with chip breaker help the evacuation of wooden chips from the slot.



DIMENSIONI DIMENSIONS										ARTICOLI ITEMS		PREZZI €
D	B	LU	DS	LS	LT	β°	H	Z TOT	SX / LH	DX / RH	PRICE €	
DIAMETER	THICKNESS	USEFUL LENGTH	SHANK DIAMETER	SHANK LENGTH	TOT. LENGTH	AXIAL ANG.	NEG	TOTAL TEETH	CODICE / SKU	CODICE / SKU		
14	90	22	16	50	150	10°+/-	4	7	FPD2052003	FPD2052004		
16	90	22	16	50	150	10°+/-	4	7	FPD2052005	FPD2052006		
16	110	22	16	50	170	10°+/-	4	7	FPD2052007	FPD2052008		
14	90	34	14	50	150	10°+/-	4	10	FPD2052013	FPD2052014		
14	90	34	16	50	150	10°+/-	4	10	FPD2052015	FPD2052016		
16	90	34	16	50	150	10°+/-	4	10	FPD2052017	FPD2052018		
16	110	34	16	50	170	10°+/-	4	10	FPD2052019	FPD2052020		

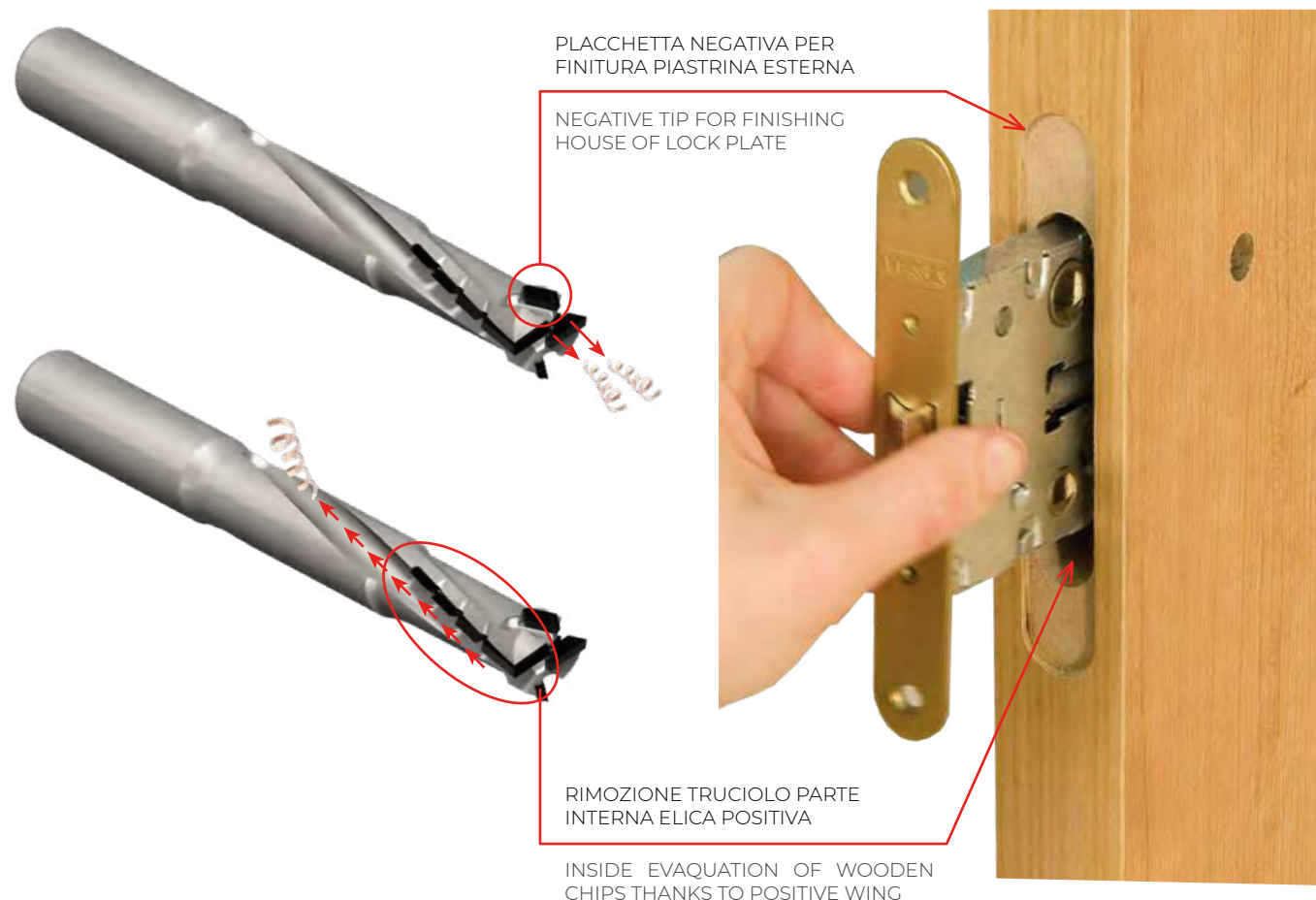

AVANTECH 3 MINI FRESA PER CAVE SERRATURE MINI DI PORTE FPD2062

NEW

FRESA IN DIAMANTE Z2+2
PER CAVE SERRATURE DI PORTE
CORPO IN DENSIMET

PCD HELICOIDAL SHANK CUTTERS Z2+2
FOR MACHINING DOOR LOCKS
HDM (HIGH DENSITY METAL) BODY

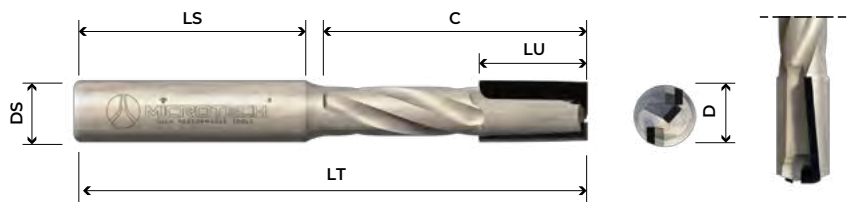

Fresa elica per cave di serrature porte di piccole dimensioni, speciale geometria costruttiva, eccellente finitura nella parte esterna della piastrina e elevata capacità di asportazione all'interno della cava. Corpo in metallo pesante per ridurre notevolmente le vibrazioni aumentando la durata del tagliente, si raccomanda ingresso in interpolazione a rampa.

PCD helicoidal shank cutter Z2+2 for machining door locks with body anti-vibration in HDM (High density metal). The two negative tips give a good finishing during the operation for the slot the others two positive tips with chip breaker help the evacuation of wooden chips from the slot.



DIMENSIONI DIMENSIONS						ARTICOLI ITEMS				PREZZI €	
D	C	LU	DS	LS	LT	β°	Z TOT	Z TOT	SX / LH	DX / RH	PRICE €
DIAMETER	THICKNESS	USEFUL LENGTH	SHANK DIAMETER	SHANK LENGTH	TOT. LENGTH	AXIAL ANG.	T. TEETH	T. TEETH	CODICE / SKU	CODICE / SKU	
12	50	20	12	45	100	5-	2	3	FPD2062001	FPD2062002	
12	70	20	12	45	120	5-	2	3	FPD2062003	FPD2062004	



FINISH 1 FPD2501

FRESA ELICOIDALE IN HW POSITIVA Z1

HW MILLING CUTTERS Z1 POSITIVE

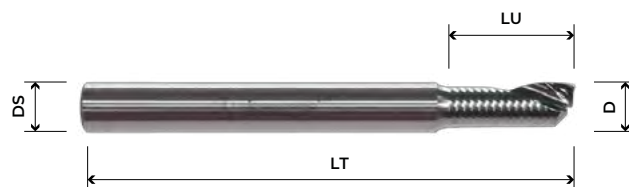

Fresa elicoidale in HW con tagliente positivo Z1. Ideale per contornare, sezionare, e sagomare a misura legno massiccio e derivati, pannelli laminati e materie plastiche.

HW milling cutters Z1 positive. Suitable for routing, cutting and profiling on solid wood, laminated chipboard panels and plastic material.

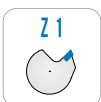

DIMENSIONI DIMENSIONS				ARTICOLI ITEMS			PREZZI €
D DIAMETER	LU USEFUL LENGTH	DS SHANK DIAMETER	LT TOT. LENGTH	Z EFF ACTUAL TEETH	SX / LH CODICE / SKU	DX / RH CODICE / SKU	PRICE €
2	6	6	50	1	FPD2501045	FPD2501046	
3	12	3	50	1	FPD2501001	FPD2501002	
3	12	6	50	1	FPD2501057	FPD2501058	
3	17	6	60	1	FPD2501047	FPD2501048	
4	10	4	50	1	FPD2501049	FPD2501050	
4	15	4	50	1	FPD2501003	FPD2501004	
4	20	4	50	1	FPD2501005	FPD2501006	
5	17	5	50	1	FPD2501007	FPD2501008	
5	22	5	60	1	FPD2501009	FPD2501010	
6	10	8	80	1	FPD2501051	FPD2501052	
6	17	6	60	1	FPD2501011	FPD2501012	
6	22	6	60	1	FPD2501013	FPD2501014	
6	27	6	60	1	FPD2501015	FPD2501016	
8	22	8	70	1	FPD2501017	FPD2501018	
8	25	8	100	1	FPD2501053	FPD2501054	
8	32	8	80	1	FPD2501019	FPD2501020	
10	25	10	100	1	FPD2501055	FPD2501056	
10	32	10	80	1	FPD2501021	FPD2501022	
10	42	10	90	1	FPD2501023	FPD2501024	
10	52	10	90	1	FPD2501025	FPD2501026	
12	32	12	80	1	FPD2501027	FPD2501028	
12	42	12	100	1	FPD2501029	FPD2501030	
12	52	12	100	1	FPD2501031	FPD2501032	
14	42	14	100	1	FPD2501033	FPD2501034	
14	52	14	100	1	FPD2501035	FPD2501036	
16	42	16	100	1	FPD2501037	FPD2501038	
16	52	16	100	1	FPD2501039	FPD2501040	
16	62	16	130	1	FPD2501041	FPD2501042	
16	72	16	130	1	FPD2501043	FPD2501044	

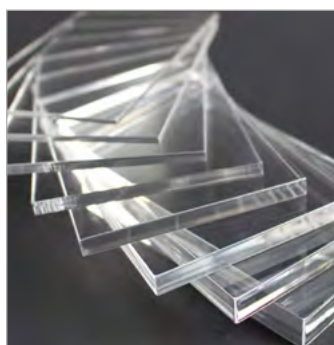

FINISH 2 FPD2502

FRESA ELICOIDALE IN HW NEGATIVA Z1
HW MILLING CUTTERS Z1 NEGATIVE

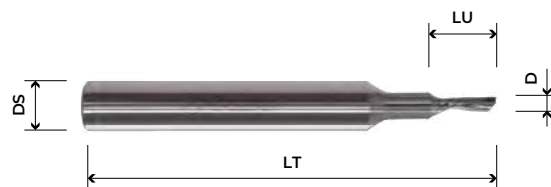

Fresa elicoidale in HW con tagliente negativo Z1. Ideale per contornare, sezionare, e sagomare a misura legno massiccio e derivati, pannelli laminati e materie plastiche.

HW milling cutters Z1 positive. Suitable for routing, cutting and profiling on solid wood, laminated chipboard panels and plastic material.



DIMENSIONI DIMENSIONS				ARTICOLI ITEMS			PREZZI €
D DIAMETER	LU USEFUL LENGHT	DS SHANK DIAMETER	LT TOT. LENGTH	Z EFF ACTUAL TEETH	SX / LH CODICE / SKU	DX / RH CODICE / SKU	PRICE €
2	6	6	50	1	FPD2502045	FPD2502046	
3	12	3	50	1	FPD2502001	FPD2502002	
4	15	4	50	1	FPD2502003	FPD2502004	
4	20	4	50	1	FPD2502005	FPD2502006	
5	17	5	50	1	FPD2502007	FPD2502008	
5	22	5	60	1	FPD2502009	FPD2502010	
6	17	6	60	1	FPD2502011	FPD2502012	
6	22	6	60	1	FPD2502013	FPD2502014	
6	27	6	60	1	FPD2502015	FPD2502016	
8	22	8	70	1	FPD2502017	FPD2502018	
8	32	8	80	1	FPD2502019	FPD2502020	
10	32	10	80	1	FPD2502021	FPD2502022	
10	42	10	90	1	FPD2502023	FPD2502024	
10	52	10	90	1	FPD2502025	FPD2502026	
12	32	12	80	1	FPD2502027	FPD2502028	
12	42	12	100	1	FPD2502029	FPD2502030	
12	52	12	100	1	FPD2502031	FPD2502032	
14	42	14	100	1	FPD2502033	FPD2502034	
14	52	14	100	1	FPD2502035	FPD2502036	
16	42	16	100	1	FPD2502037	FPD2502038	
16	52	16	100	1	FPD2502039	FPD2502040	
16	62	16	130	1	FPD2502041	FPD2502042	
16	72	16	130	1	FPD2502043	FPD2502044	

FINISH 3 FPD2503

FRESA ELICOIDALE IN HW POSITIVA Z2

HW MILLING CUTTERS Z2 POSITIVE

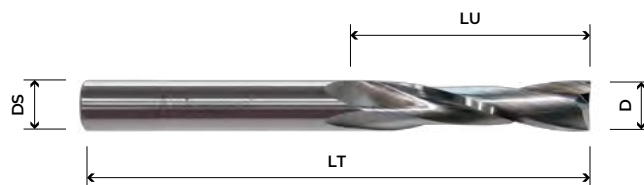

Fresa elicoidale in HW con tagliente positivo Z2. Ideale per contornare, sezionare, e sagomare a misura legno massiccio e derivati, pannelli laminati e materie plastiche.

HW milling cutters Z2 positive. Suitable for routing, cutting and profiling on solid wood, laminated chipboard panels and plastic material.

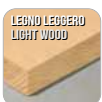

DIMENSIONI DIMENSIONS				ARTICOLI ITEMS			PREZZI €
D DIAMETER	LU USEFUL LENGTH	DS SHANK DIAMETER	LT TOT. LENGTH	Z EFF ACTUAL TEETH	SX / LH CODICE / SKU	DX / RH CODICE / SKU	PRICE €
2	8	6	50	2	FPD2503081	FPD2503082	
3	12	3	50	2	FPD2503001	FPD2503002	
3	12	6	60	2	FPD2503003	FPD2503004	
3	17	6	60	2	FPD2503067	FPD2503068	
3,5	12	6	60	2	FPD2503005	FPD2503006	
3,5	20	6	60	2	FPD2503079	FPD2503080	
4	9	4	50	2	FPD2503069	FPD2503070	
4	15	4	50	2	FPD2503007	FPD2503008	
4	15	6	60	2	FPD2503009	FPD2503010	
5	17	5	50	2	FPD2503011	FPD2503012	
5	17	6	60	2	FPD2503013	FPD2503014	
5	25	6	60	2	FPD2503071	FPD2503072	
5	33	5	100	2	FPD2503077	FPD2503078	
6	17	6	60	2	FPD2503015	FPD2503016	
6	22	6	60	2	FPD2503017	FPD2503018	
6	27	6	70	2	FPD2503019	FPD2503020	
6	27	8	70	2	FPD2503021	FPD2503022	
6	35	6	70	2	FPD2503073	FPD2503074	
7	32	8	80	2	FPD2503023	FPD2503024	
8	22	8	70	2	FPD2503025	FPD2503026	
8	32	8	80	2	FPD2503027	FPD2503028	
8	42	8	90	2	FPD2503029	FPD2503030	
9	32	10	80	2	FPD2503031	FPD2503032	
10	22	10	70	2	FPD2503075	FPD2503076	
10	32	10	70	2	FPD2503033	FPD2503034	
10	42	10	90	2	FPD2503035	FPD2503036	
10	52	10	100	2	FPD2503037	FPD2503038	
12	32	12	80	2	FPD2503039	FPD2503040	
12	42	12	90	2	FPD2503041	FPD2503042	
12	52	12	100	2	FPD2503043	FPD2503044	
14	42	14	100	2	FPD2503045	FPD2503046	
14	52	14	100	2	FPD2503047	FPD2503048	
16	42	16	90	2	FPD2503049	FPD2503050	
16	52	16	100	2	FPD2503051	FPD2503052	
16	62	16	120	2	FPD2503053	FPD2503054	
16	72	16	120	2	FPD2503055	FPD2503056	
18	52	18	100	2	FPD2503057	FPD2503058	
18	72	18	120	2	FPD2503059	FPD2503060	
20	52	20	100	2	FPD2503061	FPD2503062	
20	62	20	110	2	FPD2503063	FPD2503064	
20	72	20	120	2	FPD2503065	FPD2503066	

FINISH 4 FPD2504

FRESA ELICOIDALI IN HW NEGATIVA Z2

HW MILLING CUTTERS Z2 NEGATIVE

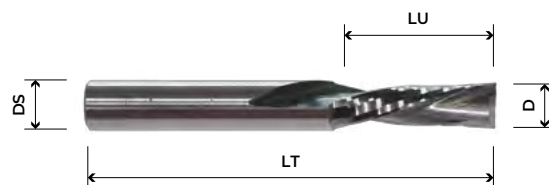

Fresa elicoidale in HW con tagliente negativo Z2. Ideale per contornare, sezionare, e sagomare a misura legno massiccio e derivati, pannelli laminati e materie plastiche.

HW milling cutters Z2 negative. Suitable for routing, cutting and profiling on solid wood, laminated chipboard panels and plastic material.

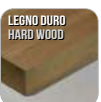

DIMENSIONI DIMENSIONS				ARTICOLI ITEMS			PREZZI €
D DIAMETER	LU USEFUL LENGHT	DS SHANK DIAMETER	LT TOT. LENGTH	Z EFF ACTUAL TEETH	SX / LH CODICE / SKU	DX / RH CODICE / SKU	PRICE €
2	6,5	6	50	2	FPD2504067	FPD2504068	
3	6,5	6	50	2	FPD2504069	FPD2504070	
3	12	3	50	2	FPD2504001	FPD2504002	
3	12	6	60	2	FPD2504003	FPD2504004	
3	17	6	50	2	FPD2504071	FPD2504072	
3,5	12	6	60	2	FPD2504005	FPD2504006	
4	12	4	50	2	FPD2504073	FPD2504074	
4	15	4	50	2	FPD2504007	FPD2504008	
4	15	6	60	2	FPD2504009	FPD2504010	
5	17	5	50	2	FPD2504011	FPD2504012	
5	17	6	60	2	FPD2504013	FPD2504014	
6	17	6	60	2	FPD2504015	FPD2504016	
6	22	6	60	2	FPD2504017	FPD2504018	
6	27	6	70	2	FPD2504019	FPD2504020	
6	27	8	70	2	FPD2504021	FPD2504022	
7	25	8	80	2	FPD2504075	FPD2504076	
7	32	8	80	2	FPD2504023	FPD2504024	
8	22	8	70	2	FPD2504025	FPD2504026	
8	32	8	80	2	FPD2504027	FPD2504028	
8	42	8	90	2	FPD2504029	FPD2504030	
9	32	10	80	2	FPD2504031	FPD2504032	
10	32	10	70	2	FPD2504033	FPD2504034	
10	42	10	90	2	FPD2504035	FPD2504036	
10	52	10	100	2	FPD2504037	FPD2504038	
12	32	12	80	2	FPD2504039	FPD2504040	
12	42	12	90	2	FPD2504041	FPD2504042	
12	52	12	100	2	FPD2504043	FPD2504044	
14	42	14	100	2	FPD2504045	FPD2504046	
14	52	14	100	2	FPD2504047	FPD2504048	
16	42	16	90	2	FPD2504049	FPD2504050	
16	52	16	100	2	FPD2504051	FPD2504052	
16	62	16	120	2	FPD2504053	FPD2504054	
16	72	16	120	2	FPD2504055	FPD2504056	
18	52	18	100	2	FPD2504057	FPD2504058	
18	72	18	120	2	FPD2504059	FPD2504060	
20	52	20	100	2	FPD2504061	FPD2504062	
20	62	20	110	2	FPD2504063	FPD2504064	
20	72	20	120	2	FPD2504065	FPD2504066	

FINISH 5 FPD2505

FRESA ELICOIDALI IN HW POSITIVA Z3
HW MILLING CUTTERS Z3 POSITIVE

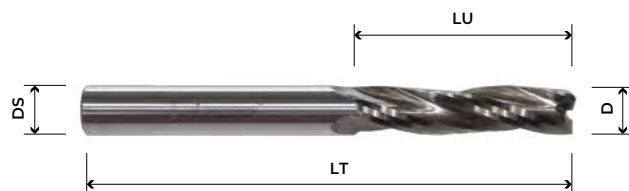

Fresa elicoidale in HW con tagliente positivo Z3. Ideale per contornare, sezionare, e sagomare a misura legno massiccio e derivati, pannelli laminati e materie plastiche.

HW milling cutters Z3 positive. Suitable for routing, cutting and profiling on solid wood, laminated chipboard panels and plastic material.

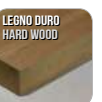
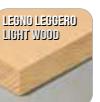

DIMENSIONI DIMENSIONS				ARTICOLI ITEMS			PREZZI €
D DIAMETER	LU USEFUL LENGTH	DS SHANK DIAMETER	LT TOT. LENGTH	Z EFF ACTUAL TEETH	SX / LH CODICE / SKU	DX / RH CODICE / SKU	PRICE €
6	25	6	60	3	FPD2505061	FPD2505062	
8	22	8	70	3	FPD2505001	FPD2505002	
8	32	8	80	3	FPD2505003	FPD2505004	
8	42	8	80	3	FPD2505063	FPD2505064	
10	22	10	70	3	FPD2505065	FPD2505066	
10	32	10	80	3	FPD2505005	FPD2505006	
10	42	10	90	3	FPD2505007	FPD2505008	
10	52	10	100	3	FPD2505009	FPD2505010	
12	32	12	80	3	FPD2505011	FPD2505012	
12	42	12	90	3	FPD2505013	FPD2505014	
12	52	12	100	3	FPD2505015	FPD2505016	
14	32	14	80	3	FPD2505017	FPD2505018	
14	42	14	90	3	FPD2505019	FPD2505020	
14	52	14	100	3	FPD2505021	FPD2505022	
16	42	16	90	3	FPD2505023	FPD2505024	
16	52	16	100	3	FPD2505025	FPD2505026	
16	62	16	110	3	FPD2505027	FPD2505028	
16	72	16	120	3	FPD2505029	FPD2505030	
16	90	16	150	3	FPD2505067	FPD2505068	
18	52	18	100	3	FPD2505031	FPD2505032	
18	72	18	120	3	FPD2505033	FPD2505034	
18	92	18	150	3	FPD2505073	FPD2505074	
18	102	18	150	3	FPD2505035	FPD2505036	
20	42	20	90	3	FPD2505037	FPD2505038	
20	52	20	100	3	FPD2505039	FPD2505040	
20	62	20	110	3	FPD2505041	FPD2505042	
20	72	20	120	3	FPD2505043	FPD2505044	
20	82	20	130	3	FPD2505075	FPD2505076	
20	85	20	140	3	FPD2505045	FPD2505046	
20	102	20	150	3	FPD2505047	FPD2505048	
25	52	25	100	3	FPD2505049	FPD2505050	
25	62	25	110	3	FPD2505051	FPD2505052	
25	72	25	120	3	FPD2505053	FPD2505054	
25	85	25	130	3	FPD2505055	FPD2505056	
25	102	25	150	3	FPD2505057	FPD2505058	
25	115	25	170	3	FPD2505059	FPD2505060	
25	120	25	180	3	FPD2505069	FPD2505070	
25	125	25	180	3	FPD2505071	FPD2505072	
25	130	25	190	3	FPD2505077	FPD2505078	

RAPTOR 1 FPD2506

FRESA ELICOIDALI IN HW POSITIVA Z3 CON ROMPITRUCIOLO
HW MILLING CUTTERS Z3 POSITIVE

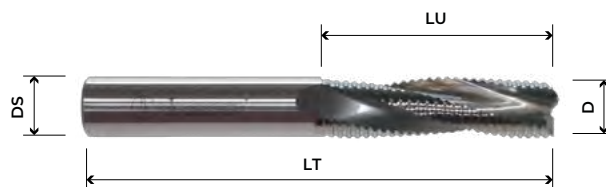

Fresa elicoidale in HW con tagliente positivo Z3 con rompitruciolo. Ideale per contornare, sezionare, e sagomare a misura legno massiccio e derivati, pannelli laminati e materie plastiche.

HW milling cutters Z3 positive for roughing. Suitable for routing, cutting and profiling on solid wood, laminated chipboard panels and plastic material.

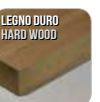
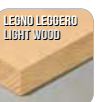

DIMENSIONI DIMENSIONS				ARTICOLI ITEMS			PREZZI €
D DIAMETER	LU USEFUL LENGHT	DS SHANK DIAMETER	LT TOT. LENGTH	Z EFF ACTUAL TEETH	SX / LH CODICE / SKU	DX / RH CODICE / SKU	PRICE €
8	22	8	70	3	FPD2506001	FPD2506002	
8	32	8	80	3	FPD2506003	FPD2506004	
8	42	8	90	3	FPD2506061	FPD2506062	
10	32	10	80	3	FPD2506005	FPD2506006	
10	42	10	90	3	FPD2506007	FPD2506008	
10	52	10	100	3	FPD2506009	FPD2506010	
12	32	12	80	3	FPD2506011	FPD2506012	
12	42	12	90	3	FPD2506013	FPD2506014	
12	52	12	100	3	FPD2506015	FPD2506016	
14	32	14	80	3	FPD2506017	FPD2506018	
14	42	14	90	3	FPD2506019	FPD2506020	
14	52	14	100	3	FPD2506021	FPD2506022	
16	42	16	90	3	FPD2506023	FPD2506024	
16	52	16	100	3	FPD2506025	FPD2506026	
16	62	16	110	3	FPD2506027	FPD2506028	
16	72	16	120	3	FPD2506029	FPD2506030	
16	82	16	130	3	FPD2506069	FPD2506070	
18	52	18	100	3	FPD2506031	FPD2506032	
18	62	18	110	3	FPD2506063	FPD2506064	
18	72	18	120	3	FPD2506033	FPD2506034	
18	102	18	150	3	FPD2506035	FPD2506036	
20	42	20	90	3	FPD2506037	FPD2506038	
20	52	20	100	3	FPD2506039	FPD2506040	
20	62	20	110	3	FPD2506041	FPD2506042	
20	72	20	120	3	FPD2506043	FPD2506044	
20	85	20	140	3	FPD2506045	FPD2506046	
20	102	20	150	3	FPD2506047	FPD2506048	
25	32	25	90	3	FPD2506065	FPD2506066	
25	42	25	90	3	FPD2506067	FPD2506068	
25	52	25	100	3	FPD2506049	FPD2506050	
25	62	25	110	3	FPD2506051	FPD2506052	
25	72	25	120	3	FPD2506053	FPD2506054	
25	85	25	130	3	FPD2506055	FPD2506056	
25	102	25	150	3	FPD2506057	FPD2506058	
25	110	25	165	3	FPD2506073	FPD2506074	
25	120	25	180	3	FPD2506059	FPD2506060	
25	130	25	190	3	FPD2506071	FPD2506072	

FINISH 6 FPD2507

FRESA ELICOIDALE IN HW NEGATIVA Z3

HW MILLING CUTTERS Z3 NEGATIVE

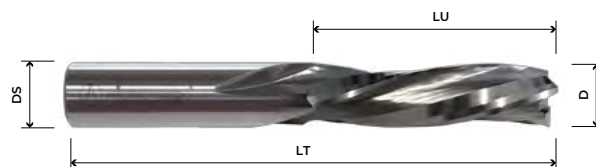

Fresa elicoidale in HW con tagliente negativo Z3. Ideale per contornare, sezionare, e sagomare a misura legno massiccio e derivati, pannelli laminati e materie plastiche.

HW milling cutters Z3 negativo for roughing. Suitable for routing, cutting and profiling on solid wood, laminated chipboard panels and plastic material.



DIMENSIONI DIMENSIONS				ARTICOLI ITEMS		PREZZI €	
D DIAMETER	LU USEFUL LENGHT	DS SHANK DIAMETER	LT TOT. LENGTH	Z EFF ACTUAL TEETH	SX / LH CODICE / SKU	DX / RH CODICE / SKU	PRICE €
8	10	8	60	3	FPD2507061	FPD2507062	
8	22	8	70	3	FPD2507001	FPD2507002	
8	32	8	80	3	FPD2507003	FPD2507004	
10	25	10	70	3	FPD2507063	FPD2507064	
10	32	10	80	3	FPD2507005	FPD2507006	
10	42	10	90	3	FPD2507007	FPD2507008	
10	52	10	100	3	FPD2507009	FPD2507010	
12	32	12	80	3	FPD2507011	FPD2507012	
12	42	12	90	3	FPD2507013	FPD2507014	
12	52	12	100	3	FPD2507015	FPD2507016	
14	32	14	80	3	FPD2507017	FPD2507018	
14	42	14	90	3	FPD2507019	FPD2507020	
14	52	14	100	3	FPD2507021	FPD2507022	
16	42	16	90	3	FPD2507023	FPD2507024	
16	52	16	100	3	FPD2507025	FPD2507026	
16	62	16	110	3	FPD2507027	FPD2507028	
16	72	16	120	3	FPD2507029	FPD2507030	
18	52	18	100	3	FPD2507031	FPD2507032	
18	72	18	120	3	FPD2507033	FPD2507034	
18	102	18	150	3	FPD2507035	FPD2507036	
20	42	20	90	3	FPD2507037	FPD2507038	
20	52	20	100	3	FPD2507039	FPD2507040	
20	62	20	110	3	FPD2507041	FPD2507042	
20	72	20	120	3	FPD2507043	FPD2507044	
20	85	20	140	3	FPD2507045	FPD2507046	
20	102	20	150	3	FPD2507047	FPD2507048	
25	32	25	100	3	FPD2507065	FPD2507066	
25	52	25	100	3	FPD2507049	FPD2507050	
25	62	25	110	3	FPD2507051	FPD2507052	
25	72	25	120	3	FPD2507053	FPD2507054	
25	85	25	130	3	FPD2507055	FPD2507056	
25	102	25	150	3	FPD2507057	FPD2507058	
25	120	25	180	3	FPD2507059	FPD2507060	

AVANTECH 4 KNIVES DOOR FPD2521

NEW

FRESA A COLTELLINI PER SCASSI
SERRATUREPORTE CORPO HDM

HEAVY STEEL CUTTER FOR LOCK-SET

Fresa per scassi serrature porte con coltellini intercambiabili reversibili e corpo in HDM metallo pesante antivibrante.

Shank cutter for door locks with interchangeable reversible knives and body in HDM anti-vibration heavy metal.

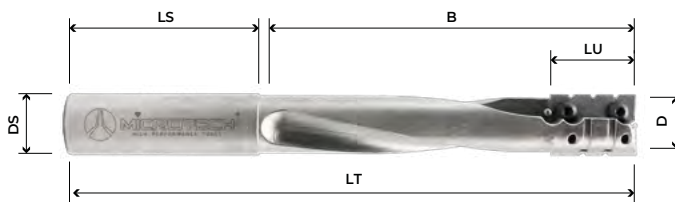

DIMENSIONI DIMENSIONS							ARTICOLI ITEMS	PREZZI €
D	B	LU	DS	LS	LT	Z EFF	DX / RH	PREZZI €
DIAMETER	THICKNESS	USEFUL LENGTH	SHANK DIAMETER	SHANK LENGTH	TOT. LENGTH	ACTUAL TEETH	CODICE / SKU	PRICE €
14	95	23	14	50	150	2	FPD2521001	NEW
16	95	23	16	50	150	2	FPD2521002	NEW

RICAMBI PARTS					
		COLTELLINO 2 RT	PREZZO	COLTELLINO 3 RT	PREZZO
		SCREW	PRICE	SCREW	PRICE
FPD2521001	RIC9036003	23X6X1,5		RIC9039002	23X6X1,5
FPD2521002	RIC9036002	23X7X1,5		RIC9039001	23X7X1,5
		VITE	PREZZO	CHIAVE	PREZZO
		SCREW	PRICE	KEY	PRICE
FPD2521001	RIC9007145	M3X4X6 T9		RIC9013011	CHIAVE TORX T9
FPD2521002	RIC9007145	M3X4X6 T9		RIC9013011	CHIAVE TORX T9

FPD
FRESA PANTOGRAFO DRITE
STRAIGHT SHANK CUTTERS

AVANTECH 2 FPD2518

FRESA ELICOIDALE PER CAVE SERRATURE DI PORTE IN HW POSITIVA ROMPITRUCIOLO Z3 CON PARTE NEGATIVA DI FINITURA PER LAVORAZIONE PIASTRINA

HW POSITIVE SHANK CUTTER TO WORK DOOR LOCK SLOT. CHIP BREAKER Z3 WITH NEGATIVE PART FOR BETTER FINISHING OF PLATE HOUSE

Fresa elicoidale in HW con tagliente positivo Z3 con rompitruciolo e parte negativa di finitura per lavorazione della piastrina. Ideale per esecuzioni di cave per serrature su porte e finestre e per contornare, sezionare, e sagomare a misura legno massiccio e derivati, pannelli laminati e materie plastiche.

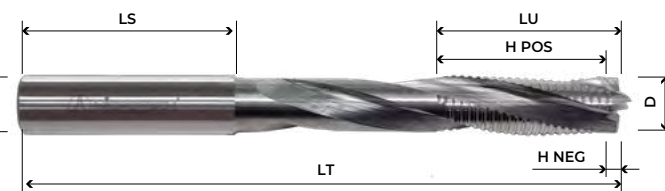

HW positive shank cutter to work door lock slot. chip breaker Z3 with negative part for better finishing of plate house. Suitable to realize door lock slot and for routing, cutting on solid wood, laminated chipboard and plastic material.



DIMENSIONI		DIMENSIONS		ARTICOLI		ITEMS		PREZZI €		
D	LU	DS	LS	LT	H	H	Z EFF	SX / LH	DX / RH	PRICE €
DIAMETER	USEFUL LENGHT	SHANK DIAMETER	SHANK LENGTH	TOT. LENGTH	NEG	POS	ACTUAL TEETH	CODICE / SKU	CODICE / SKU	
12	45	12	55	150	6,5	38,5	3	FPD2518001	FPD2518002	
14	45	14	55	150	6,5	38,5	3	FPD2518003	FPD2518004	
16	45	16	55	150	6,5	38,5	3	FPD2518005	FPD2518006	
18	45	18	55	150	6,5	38,5	3	FPD2518007	FPD2518008	
20	45	20	55	150	6,5	38,5	3	FPD2518009	FPD2518010	

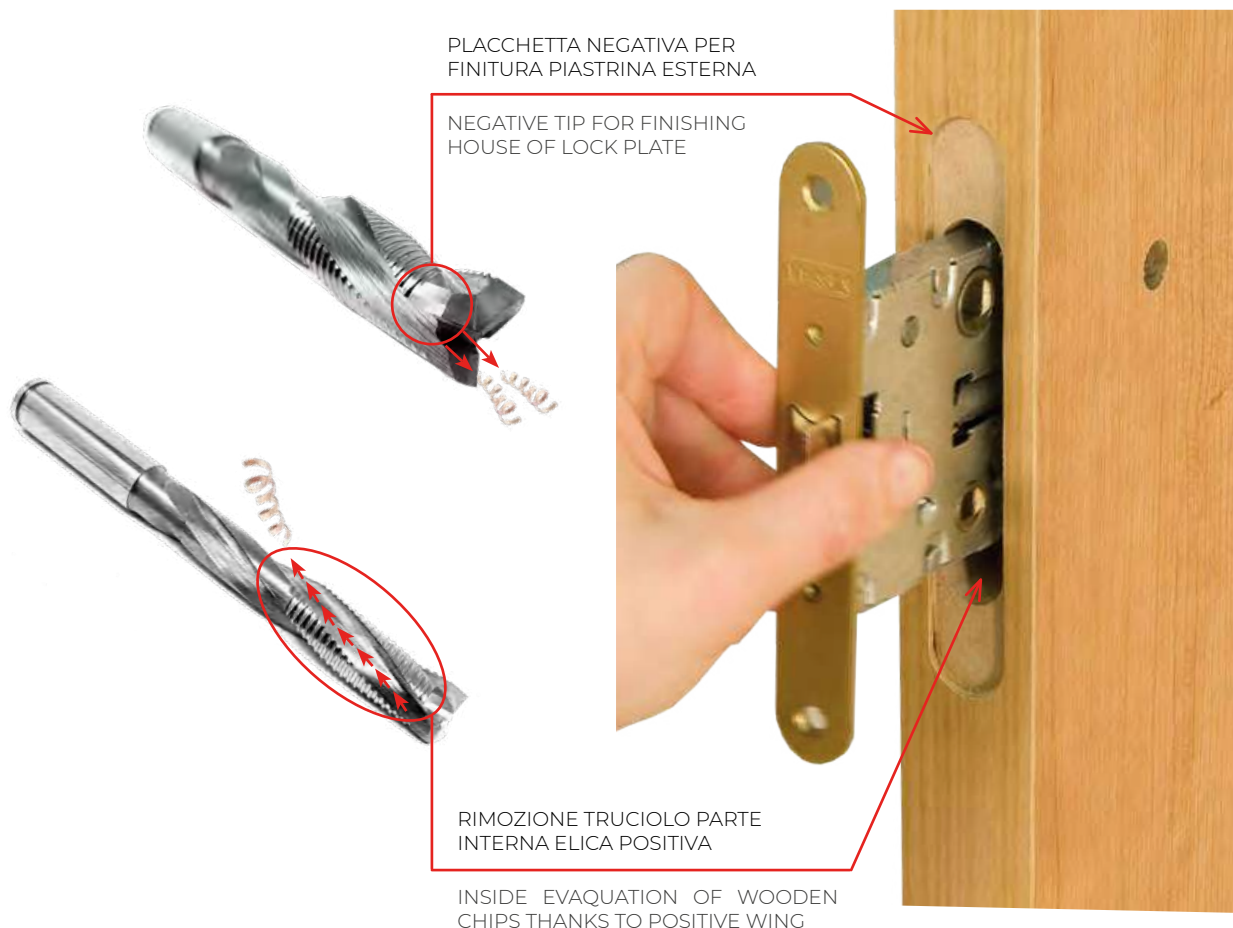

RAPTOR 2 FPD2508

FRESA ELICOIDALI IN HW NEGATIVA Z3 CON ROMPITRUCIOLO

HW MILLING CUTTERS Z3 NEGATIVE

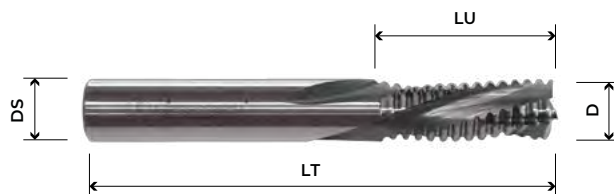

Fresa elicoidale in HW con tagliente negativo Z3 con rompitrucolo. Ideale per contornare, sezionare, e sagomare a misura legno massiccio e derivati, pannelli laminati e materie plastiche.

HW milling cutters Z3 negativo for roughing. Suitable for routing, cutting and profiling on solid wood, laminated chipboard panels and plastic material.

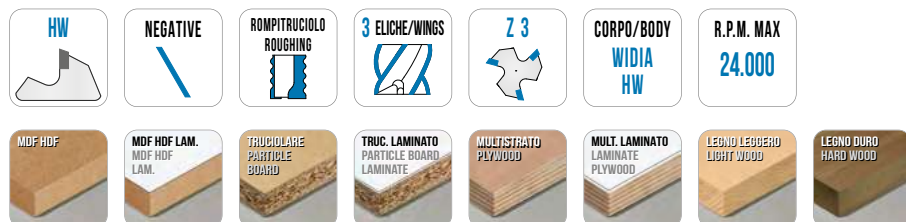

DIMENSIONI DIMENSIONS				ARTICOLI ITEMS			PREZZI €
D DIAMETER	LU USEFUL LENGHT	DS SHANK DIAMETER	LT TOT. LENGTH	Z EFF ACTUAL TEETH	SX / LH CODICE / SKU	DX / RH CODICE / SKU	PRICE €
8	22	8	70	3	FPD2508001	FPD2508002	
8	32	8	80	3	FPD2508003	FPD2508004	
10	25	10	75	3	FPD2508067	FPD2508068	
10	32	10	80	3	FPD2508005	FPD2508006	
10	42	10	90	3	FPD2508007	FPD2508008	
10	52	10	100	3	FPD2508009	FPD2508010	
12	32	12	80	3	FPD2508011	FPD2508012	
12	42	12	90	3	FPD2508013	FPD2508014	
12	52	12	100	3	FPD2508015	FPD2508016	
14	32	14	80	3	FPD2508017	FPD2508018	
14	42	14	90	3	FPD2508019	FPD2508020	
14	52	14	100	3	FPD2508021	FPD2508022	
16	42	16	90	3	FPD2508023	FPD2508024	
16	52	16	100	3	FPD2508025	FPD2508026	
16	62	16	110	3	FPD2508027	FPD2508028	
16	72	16	120	3	FPD2508029	FPD2508030	
18	52	18	100	3	FPD2508031	FPD2508032	
18	72	18	120	3	FPD2508033	FPD2508034	
18	102	18	150	3	FPD2508035	FPD2508036	
20	42	20	90	3	FPD2508037	FPD2508038	
20	52	20	100	3	FPD2508039	FPD2508040	
20	62	20	110	3	FPD2508041	FPD2508042	
20	72	20	120	3	FPD2508043	FPD2508044	
20	85	20	140	3	FPD2508045	FPD2508046	
20	102	20	150	3	FPD2508047	FPD2508048	
25	52	25	100	3	FPD2508049	FPD2508050	
25	62	25	110	3	FPD2508051	FPD2508052	
25	72	25	120	3	FPD2508053	FPD2508054	
25	85	25	130	3	FPD2508055	FPD2508056	
25	102	25	150	3	FPD2508057	FPD2508058	
25	120	25	180	3	FPD2508059	FPD2508060	

FINISH 7 FPD2509

FRESE ELICOIDALI IN HW POSITIVA Z3
PER CAVE SERRATURE DI PORTE

HW MILLING CUTTERS Z3 POSITIVE
FOR MACHINING DOOR LOCKS

Fresa elicoidale in HW con tagliente positivo Z3. Ideale per contornare, sezionare, e sagomare a misura legno massiccio e derivati, pannelli laminati e materie plastiche. Ideale per esecuzioni di cave per serrature su porte e finestre.

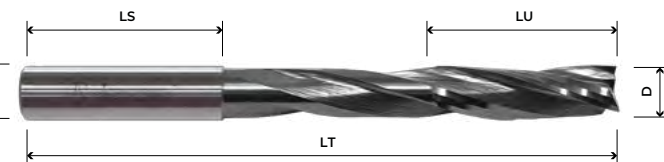

Helicoidal solid carbide router Z3 with three positive spiral. Suitable for routing, cutting and profiling on solid wood, laminated chipboard panels and plastic material. Suitable for locksets by gradualinfeed.



DIMENSIONI DIMENSIONS					ARTICOLI ITEMS			PREZZI €
D	LU	DS	LS	LT	Z EFF	SX / LH	DX / RH	PRICE €
DIAMETER	USEFUL LENGTH	SHANK DIAMETER	SHANK LENGTH	TOT. LENGTH	ACTUAL TEETH	CODICE / SKU	CODICE / SKU	
12	45	12	55	150	3	FPD2509001	FPD2509002	
14	45	14	55	150	3	FPD2509003	FPD2509004	
16	45	16	55	150	3	FPD2509005	FPD2509006	
18	45	18	55	150	3	FPD2509007	FPD2509008	
20	45	20	55	150	3	FPD2509009	FPD2509010	

RAPTOR 3 FPD2510

FRESA ELICOIDALE IN HW POSITIVA Z3
CON ROMPIRUCIOLO PER CAVE SERRATURE DI PORTE

HW MILLING CUTTERS FOR MACHINING DOOR LOCKS
FOR ROUGHING Z3 POSITIVE

Fresa elicoidale in HW con tagliente positivo Z3 con rompitrucciolo. Ideale per contornare, sezionare, e sagomare a misura legno massiccio e derivati, pannelli laminati e materie plastiche. Ideale per esecuzioni di cave per serrature su porte e finestre.

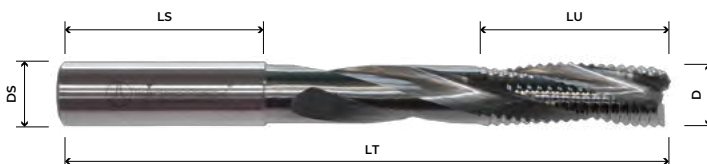

HW milling cutters for finishing Z3 positive for roughing. Suitable for routing, cutting and profiling on solid wood, laminated chipboard panels and plastic material. Suitable for locksets by gradualinfeed.



DIMENSIONI DIMENSIONS					ARTICOLI ITEMS			PREZZI €
D	LU	DS	LS	LT	Z EFF	SX / LH	DX / RH	PRICE €
DIAMETER	USEFUL LENGTH	SHANK DIAMETER	SHANK LENGTH	TOT. LENGTH	ACTUAL TEETH	CODICE / SKU	CODICE / SKU	
12	45	12	55	150	3	FPD2510001	FPD2510002	
14	45	14	55	150	3	FPD2510003	FPD2510004	
16	45	16	55	150	3	FPD2510005	FPD2510006	
18	45	18	55	150	3	FPD2510007	FPD2510008	
20	45	20	55	150	3	FPD2510009	FPD2510010	

FINISH 8 FPD2511

FRESE ELICOIDALI IN HW NEGATIVA Z3
PER CAVE SERRATURE DI PORTE

HW MILLING CUTTERS Z3 NEGATIVE
FOR MACHINING DOOR LOCKS

Fresa elicoidale in HW con tagliente negativo Z3. Ideale per contornare, sezionare, e sagomare a misura legno massiccio e derivati, pannelli laminati e materie plastiche. Ideale per esecuzioni di cave per serrature su porte e finestre.

HW milling cutters Z3 negative. Suitable for routing, cutting and profiling on solid wood, laminated chipboard panels and plastic material. Suitable for looksets by gradualinfeed.

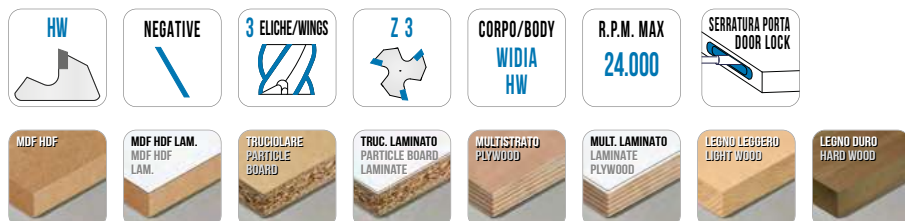

DIMENSIONI DIMENSIONS					ARTICOLI ITEMS		PREZZI €	
D	LU	DS	LS	LT	Z EFF	SX / LH	DX / RH	PRICE €
DIAMETER	USEFUL LENGHT	SHANK DIAMETER	SHANK LENGTH	TOT. LENGTH	ACTUAL TEETH	CODICE / SKU	CODICE / SKU	
12	45	12	55	150	3	FPD2511001	FPD2511002	
14	45	14	55	150	3	FPD2511003	FPD2511004	
16	45	16	55	150	3	FPD2511005	FPD2511006	
18	45	18	55	150	3	FPD2511007	FPD2511008	
20	45	20	55	150	3	FPD2511009	FPD2511010	

RAPTOR 4 FPD2512

FRESA ELICOIDALE IN HW NEGATIVA Z3
CON ROMPITRUCIOLO PER CAVE SERRATURE DI PORTE

HW MILLING CUTTERS FOR MACHINING DOOR LOCKS
FOR ROUGHING Z3 NEGATIVE

Fresa elicoidale in HW con tagliente negativo Z3 con rompitrucio. Ideale per contornare, sezionare, e sagomare a misura legno massiccio e derivati, pannelli laminati e materie plastiche. Ideale per esecuzioni di cave per serrature su porte e finestre.

HW milling cutters for finishing Z3 negative for roughing. Suitable for routing, cutting and profiling on solid wood, laminated chipboard panels and plastic material. Suitable for looksets by gradualinfeed.

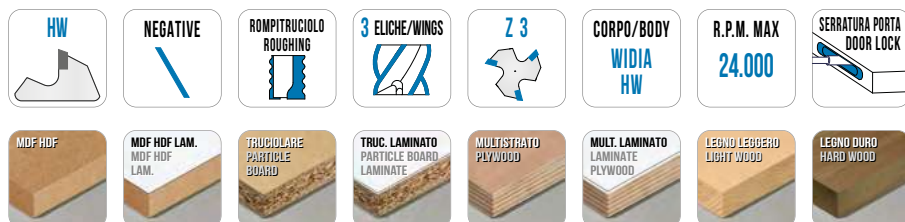
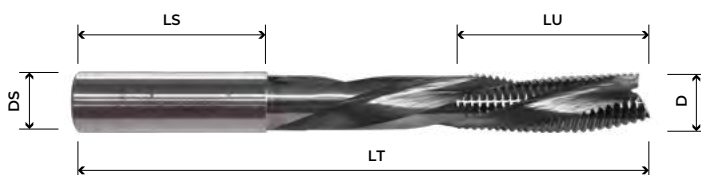

DIMENSIONI DIMENSIONS					ARTICOLI ITEMS		PREZZI €	
D	LU	DS	LS	LT	Z EFF	SX / LH	DX / RH	PRICE €
DIAMETER	USEFUL LENGHT	SHANK DIAMETER	SHANK LENGTH	TOT. LENGTH	ACTUAL TEETH	CODICE / SKU	CODICE / SKU	
12	45	12	55	150	3	FPD2512001	FPD2512002	
14	45	14	55	150	3	FPD2512003	FPD2512004	
16	45	16	55	150	3	FPD2512005	FPD2512006	
18	45	18	55	150	3	FPD2512007	FPD2512008	
20	45	20	55	150	3	FPD2512009	FPD2512010	

FINISH 9 FPD2514

FRESA ELICOIDALE IN HW UP-DOWN
POSITIVA / NEGATIVA Z2+2

HW DOUBLE ACTION MILLING CUTTERS
Z2+2 POSITIVE / NEGATIVE

Fresa elicoidale in HW con tagliente positivo/negativo Z2+2. Ottima finitura in entrambe le direzioni del pannello lavorato. Ideale per contornare, sezionare, e sagomare a misura legno massiccio, derivati, pannelli laminati e materie plastiche.

Helicoidal solid carbide router Z2+2 with positive/negative spiral cut. Suitable for routing, cutting and shape the panels on solid wood, chipboard and plastic materials.

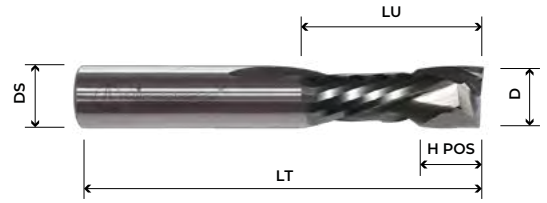

DIMENSIONI DIMENSIONS					ARTICOLI ITEMS		PREZZI €	
D DIAMETER	LU USEFUL LENGHT	H POS	DS SHANK DIAMETER	LT TOT. LENGTH	Z EFF ACTUAL TEETH	SX / LH CODICE / SKU	DX / RH CODICE / SKU	PRICE €
5	22	4	5	70	2	FPD2514041	FPD2514042	
5	32	4	5	70	2	FPD2514039	FPD2514040	
6	22	7	6	70	2	FPD2514001	FPD2514002	
6	32	7	6	80	2	FPD2514003	FPD2514004	
7	22	7	8	70	2	FPD2514043	FPD2514044	
7	32	7	8	70	2	FPD2514037	FPD2514038	
8	22	7	8	70	2	FPD2514005	FPD2514006	
8	32	7	8	80	2	FPD2514007	FPD2514008	
10	32	7	10	80	2	FPD2514009	FPD2514010	
10	42	7	10	100	2	FPD2514011	FPD2514012	
10	52	7	10	100	2	FPD2514013	FPD2514014	
12	32	7	12	80	2	FPD2514015	FPD2514016	
12	42	7	12	100	2	FPD2514017	FPD2514018	
12	52	7	12	100	2	FPD2514019	FPD2514020	
14	52	24	14	100	2	FPD2514021	FPD2514022	
16	42	24	16	100	2	FPD2514023	FPD2514024	
16	52	24	16	110	2	FPD2514025	FPD2514026	
16	72	24	16	130	2	FPD2514027	FPD2514028	
18	52	30	18	110	2	FPD2514029	FPD2514030	
18	72	30	18	130	2	FPD2514031	FPD2514032	
20	52	30	20	120	2	FPD2514033	FPD2514034	
20	72	30	20	130	2	FPD2514035	FPD2514036	

POWERCUT 7W FPD25 16

FRESA ELICOIDALE PER NESTING IN HW RIVESTITA
UP-DOWN POSITIVA/NEGATIVA Z2+2

HW DOUBLE ACTION MILLING CUTTERS
FOR HIGH SPEED NESTING Z2+2 POSITIVE/NEGATIVE

Fresa elicoidale in HW con tagliente positivo/negativo Z2+2 per lavorazione nesting ad alta velocità e durata. Ottima finitura in entrambe le direzioni del pannello lavorato. Ideale per contornare, sezionare, e sagomare a misura legno massiccio, pannelli laminati in MDF, truciolare e multistrato.

Solid carbide high speed router Z2+2 with positive/negative spiral cut. Suitable for nesting operation and also routing, cutting and shape the panels on solid wood, chipboard, MDF and plywood material.

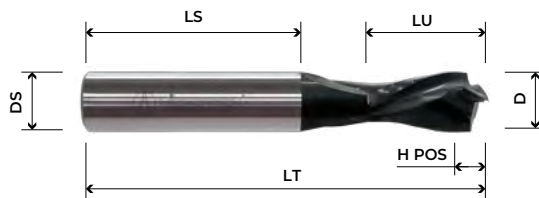

DIMENSIONI		DIMENSIONS		ARTICOLI		ITEMS		PREZZI €	
D	LU	H HPOS	DS	LS	LT	Z EFF	DX / RH		PRICE €
DIAMETER	USEFUL LENGTH		SHANK DIAMETER	SHANK LENGTH	TOT. LENGTH	ACTUAL TEETH	CODICE / SKU		
10	22	5	10	45	70	2	FPD2516002		
10	27	5	10	45	75	2	FPD2516004		
10	35	5	10	45	80	2	FPD2516006		
12	22	5	12	50	75	2	FPD2516008		
12	27	5	12	50	80	2	FPD2516010		
12	35	5	12	50	80	2	FPD2516012		
3/8"	7/8"	0,2"	3/8"	1" 5/8"	3"	2	FPD2516014		
3/8"	1" 1/8"	0,2"	3/8"	1" 5/8"	3"	2	FPD2516016		
3/8"	1" 3/8"	0,2"	3/8"	1" 5/8"	3" 1/2"	2	FPD2516018		
1/2"	7/8"	0,2"	1/2"	1" 7/8"	3"	2	FPD2516020		
1/2"	1" 1/8"	0,2"	1/2"	1" 7/8"	3" 1/2"	2	FPD2516022		
1/2"	1" 3/8"	0,2"	1/2"	1" 7/8"	3" 1/2"	2	FPD2516024		

FINISH 11 FPD2519

NEW

FRESA ELICOIDALE IN WIDIA POSITIVA Z2 SFERICA DI FINITURA HELICOIDAL HW SHANK CUTTER Z2 SPHERICAL FINISHING

Fresa elicoidale in widia con tagliente positivo Z2 sferica di finitura. Ideale per lavorare superfici sferiche.

Helicoidal HW shank cutter Z2 positive spherical finishing. Suitable for working spherical surfaces.

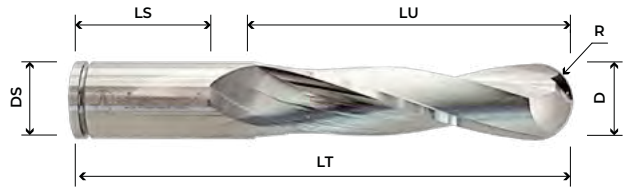

DIMENSIONI DIMENSIONS							ARTICOLI ITEMS		PREZZI €
D DIAMETER	R RADIUS	LU USEFUL LENGTH	DS SHANK DIAMETER	LS SHANK LENGTH	LT TOT. LENGTH	Z EFF ACTUAL TEETH	SX / LH CODICE / SKU	DX / RH CODICE / SKU	PRICE €
6	3	22	6	40	65	2	FPD2519001	FPD2519002	
8	4	32	8	40	80	2	FPD2519003	FPD2519004	
10	5	32	10	40	80	2	FPD2519005	FPD2519006	
10	5	52	10	40	100	2	FPD2519007	FPD2519008	
12	6	32	12	40	80	2	FPD2519009	FPD2519010	
12	6	52	12	40	100	2	FPD2519011	FPD2519012	
14	7	52	14	50	110	2	FPD2519013	FPD2519014	
16	8	52	16	50	110	2	FPD2519015	FPD2519016	
16	8	72	16	50	130	2	FPD2519017	FPD2519018	
20	10	52	20	50	110	2	FPD2519019	FPD2519020	
20	10	62	20	50	120	2	FPD2519021	FPD2519022	
20	10	72	20	50	130	2	FPD2519023	FPD2519024	
20	10	82	20	50	140	2	FPD2519025	FPD2519026	

FINISH 12 FPD2520

NEW

FRESA ELICOIDALE IN HW POSITIVA Z3
CON ROMPITRUCIOLO DI FINITURA

HELICOIDAL HW SHANK CUTTER Z3
POSITIVE WITH FINISHING CHIPS BREAKERS

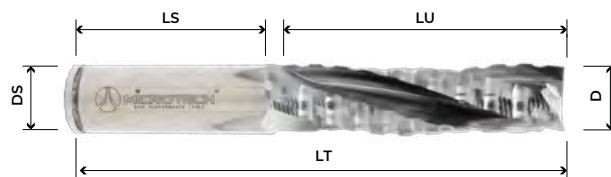

Fresa elicoidale in widia con tagliente positivo Z3 con rompitruciole di finitura. Ideale per contornare, sezionare, e sagomare a misura legno massiccio e derivati, pannelli laminati e materie plastiche.

Helicoidal HW shank cutter Z3 positive with finishing chips breakers. Suitable for rounding, sizing and profiling custom-made hardwood and derivatives, laminated panels and plastic materials.

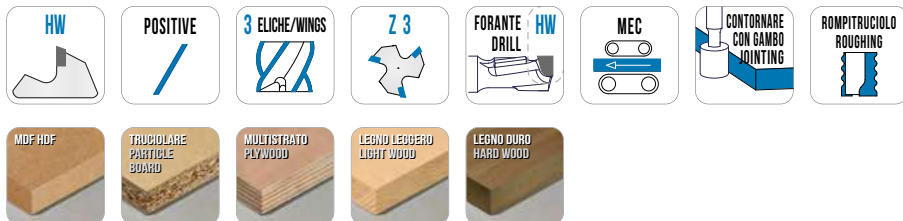

DIMENSIONI DIMENSIONS				ARTICOLI ITEMS		PREZZI €	
D DIAMETER	LU USEFUL LENGHT	DS SHANK DIAMETER	LT TOT. LENGTH	Z EFF ACTUAL TEETH	SX / LH CODICE / SKU	DX / RH CODICE / SKU	PRICE €
8	22	8	70	3	FPD2520001	FPD2520002	
8	32	8	80	3	FPD2520003	FPD2520004	
8	42	8	90	3	FPD2520061	FPD2520062	
10	32	10	80	3	FPD2520005	FPD2520006	
10	42	10	90	3	FPD2520007	FPD2520008	
10	52	10	100	3	FPD2520009	FPD2520010	
12	32	12	80	3	FPD2520011	FPD2520012	
12	42	12	90	3	FPD2520013	FPD2520014	
12	52	12	100	3	FPD2520015	FPD2520016	
14	32	14	80	3	FPD2520017	FPD2520018	
14	42	14	90	3	FPD2520019	FPD2520020	
14	52	14	100	3	FPD2520021	FPD2520022	
16	42	16	90	3	FPD2520023	FPD2520024	
16	52	16	100	3	FPD2520025	FPD2520026	
16	62	16	110	3	FPD2520027	FPD2520028	
16	72	16	120	3	FPD2520029	FPD2520030	
16	82	16	130	3	FPD2520069	FPD2520070	
18	52	18	100	3	FPD2520031	FPD2520032	
18	62	18	110	3	FPD2520063	FPD2520064	
18	72	18	120	3	FPD2520033	FPD2520034	
18	102	18	150	3	FPD2520035	FPD2520036	
20	42	20	90	3	FPD2520037	FPD2520038	
20	52	20	100	3	FPD2520039	FPD2520040	
20	62	20	110	3	FPD2520041	FPD2520042	
20	72	20	120	3	FPD2520043	FPD2520044	
20	85	20	140	3	FPD2520045	FPD2520046	
20	102	20	150	3	FPD2520047	FPD2520048	
25	32	25	90	3	FPD2520065	FPD2520066	
25	42	25	90	3	FPD2520067	FPD2520068	
25	52	25	100	3	FPD2520049	FPD2520050	
25	62	25	110	3	FPD2520051	FPD2520052	
25	72	25	120	3	FPD2520053	FPD2520054	
25	85	25	130	3	FPD2520055	FPD2520056	
25	102	25	150	3	FPD2520057	FPD2520058	
25	110	25	165	3	FPD2520073	FPD2520074	
25	120	25	180	3	FPD2520059	FPD2520060	
25	130	25	190	3	FPD2520071	FPD2520072	



FRESE PANTOGRAFO SAGOMATE

PROFILED SHANK CUTTERS



T-SLOT FPS3008

FRESA T-SLOT IN DIAMANTE PER CAVE PROFILI DI ALLUMINIO Z2+2

PCD T-SLOT BITS FOR ALUMINUM PROFILES Z2+2

145 PAG.



RADIUS 5 FPS3034 **NEW**

FRESA SFERICA IN DIAMANTE PER LAVORAZIONE SUPERFICI

SPHERICAL SHANK CUTTER IN DIAMOND FOR PANEL SURFACE

153 PAG.



LAMELLO 3 FPS3009

FRESA DIAMANTE PER GIUNZIONI LAMELLO CLAMEX P-SYSTEM Z1

PCD SHANK CUTTER Z1 FOR LAMELLO CLAMEX P-SYSTEM Z1

146 PAG.



VARIO 3 FPS3502 **NEW**

FRESA ORIENTABILE CON COLTELLINO REVERSIBILE IN HW

ADJUSTABLE CUTTER WITH INTERCHANGEABLE HW KNIFE

154 PAG.



LAMELLO 4 FPS3501

FRESA IN HW NEGATIVA Z2 PER GIUNZIONI LAMELLO CLAMEX P-SYSTEM

HW SHANK CUTTER Z2 NEGATIVE FOR LAMELLO CLAMEX P-SYSTEM

146 PAG.



VARIO 2 FPS3503 **NEW**

FRESA ORIENTABILE CON COLTELLINO REVERSIBILE IN HW

ADJUSTABLE CUTTER WITH INTERCHANGEABLE HW KNIFE

155 PAG.



LAMELLO 6 FPS3030 **NEW**

FRESA DIAMANTE NESTING PER GIUNZIONI LAMELLO CLAMEX P-SYSTEM

SHANK CUTTER FOR LAMELLO CLAMEX P-SYSTEM JUNCTIONS ON NESTING

147 PAG.



V CUT 4 FPS3014

FRESA CONICA IN DIAMANTE PER CANALI A V FOLDING A 45° Z2 PER DIBOND

PCD "V" GROOVING SHANK CUTTER AT 45° FOR FOLDING OPERATION Z2 USED ON DIBOND

156 PAG.



JOINT CUT 1 FPS3010

FRESA DA PANTOGRAFO IN DIAMANTE PER GIUNZIONI

PCD FINGER JOINT SHANK CUTTER

148 PAG.



V CUT 5 FPS3015

FRESA CONICA IN DIAMANTE PER CANALI A V FOLDING E SMUSSI A 60° E FINITURE INTERNE AGLI ANGOLI A 90° Z2

PCD "V" GROOVING SHANK CUTTER AT 60° FOR FOLDING AND CHAMFERING OPERATIONS Z2 AND 90° FOR INSIDE ANGLES

157 PAG.



V CUT 1 FPS3011

FRESA CONICA IN DIAMANTE PER CANALI A V FOLDING E SMUSSI A 45° Z2

PCD "V" GROOVING AND FOR CHAMFERING AT 45° Z2

149 PAG.



RADIUS 1 FPS3016

FRESA SFERICA IN DIAMANTE Z2

PCD BALL NOSE SHANK CUTTER Z2

158 PAG.



V CUT 2 FPS3012

FRESA CONICA IN DIAMANTE PER CANALI A V FOLDING E SMUSSI A 45° Z1+1

PCD "V" FOLDING GROOVING AND FOR CHAMFERING AT 45° Z1+1

150 PAG.



RADIUS 2 FPS3017

FRESA IN DIAMANTE A RAGGIO CONCAVO Z2

PCD QUARTER ROUND SHANK CUTTER Z2

159 PAG.

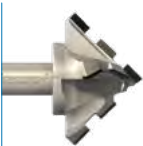

V CUT 3 FPS3013

FRESA CONICA IN DIAMANTE PER CANALI A V FOLDING E SMUSSI A 45° Z2+2

PCD "V" FOLDING GROOVING AND FOR CHAMFERING AT 45° Z2+2

151 PAG.



RADIUS 3 FPS3028

FRESA IN DIAMANTE MEZZO TONDO Z2

PCD HALF ROUND SHANK CUTTER Z2

160 PAG.



V CUT 7 FPS3504 **NEW**

FRESA A COLTELLINI REVERSIBILI IN HW PER SMUSSARE

SHANK CUTTER WITH HW INSERT KNIFE FOR CHAMFERING

152 PAG.



RADIUS 4 FPS3029

FRESA IN DIAMANTE MEZZO TONDO Z2+2

PCD HALF ROUND SHANK CUTTER Z2+2

161 PAG.



V CUT 6 FPS3033 **NEW**

FRESA CONICA PER SMUSSI A 90° Z2+2 ASSIALE POS NEG

PVD V SHANK CUTTER Z2+2 POSITIVE AND NEGATIVE AXIAL CUT

153 PAG.



PROFILE 1 FPS3018

FRESA PER MANIGLIE PROFILO 1

PCD SHANK CUTTER FOR HANDLE PROFILE N 1

162 PAG.



PROFILE 2 FPS3019

FRESA PER MANIGLIE
PROFILO 2
PCD SHANK CUTTER FOR HANDLE.
PROFILE N 2

162
PAG.



MFX 2 FPS3002

FRESA ALTA PRECISIONE PORTA INSERTI
INTERCAMBIABILI IN DIAMANTE
CON TAGLIENTE CENTRALE
HIGH PRECISION SHANK CUTTER MULTITASK-
ING WITH INTERCHANGEABLE PROFILED PCD
INSERTS WITH CENTER CUTTING KNIFE

168
PAG.



PROFILE 3 FPS3020

FRESA PER MANIGLIE
PROFILO 3
PCD SHANK CUTTER FOR HANDLE.
PROFILE N 3

163
PAG.



MFX 3 FPS3003

FRESA ALTA PRECISIONE PORTA INSERTI
INTERCAMBIABILI IN DIAMANTE
PER PROFILI A "V" DI 90° / 91°
HIGH PRECISION SHANK CUTTER WITH
INTERCHANGEABLE PCD PROFILED
INSERTS FOR "V" PROFILES AT 90° / 91°

169
PAG.



PROFILE 4 FPS3021

FRESA PER MANIGLIE
PROFILO 4
PCD SHANK CUTTER FOR HANDLE.
PROFILE N 4

163
PAG.



MFX 4 FPS3004

FRESA ALTA PRECISIONE PORTA INSERTI
INTERCAMBIABILI IN DIAMANTE
PER PROFILI A "V" DI 90° / 91°
HIGH PRECISION SHANK CUTTER WITH
INTERCHANGEABLE PCD PROFILED
INSERTS FOR "V" PROFILES AT 90° / 91°

170
PAG.



PROFILE 5 FPS3022

FRESA PER MANIGLIE
PROFILO 5
PCD SHANK CUTTER FOR HANDLE.
PROFILE N 5

164
PAG.

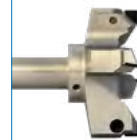

MFX 5 FPS3005

FRESA ALTA PRECISIONE PORTA INSERTI
INTERCAMBIABILI IN DIAMANTE
PER SPIANATURA E CALIBRATURA PIANI CNC
HIGH PRECISION SHANK CUTTER WITH INTER-
CHANGEABLE PCD INSERTS FOR PLANING
SLAVE PANELS AND CNC MACHINE TABLES

171
PAG.



PROFILE 6 FPS3023

FRESA PER MANIGLIE
PROFILO 6
PCD SHANK CUTTER FOR HANDLE.
PROFILE N 6

164
PAG.

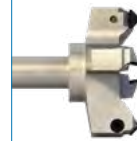

MFX 6 FPS3006

FRESA ALTA PRECISIONE PORTA INSERTI
INTERCAMBIABILI IN DIAMANTE PER
SPIANATURA E CALIBRATURA PIANI CNC
HIGH PRECISION SHANK CUTTER WITH INTER-
CHANGEABLE PCD INSERTS FOR PLANING
SLAVE PANELS AND CNC MACHINE TABLES

172
PAG.



PROFILE 7 FPS3024

FRESA PER MANIGLIE
PROFILO 7
PCD SHANK CUTTER FOR HANDLE.
PROFILE N 7

165
PAG.



MFX 8 FPS3031

PORTAINNERO FISSAGGIO
MECCANICO ORIENTABILE
SHANK CUTTER WITH PCD
SWIVELING INSERT

NEW
173
PAG.



PROFILE 8 FPS3025

FRESA PER MANIGLIE
PROFILO 8
PCD SHANK CUTTER FOR HANDLE.
PROFILE N 8

165
PAG.



MFX 9 FPS3032

PORTAINNERO FISSAGGIO
MECCANICO
PCD INSERT
SHANK CUTTER

NEW
174
PAG.



PROFILE 9 FPS3026

FRESA PER MANIGLIE
PROFILO 9
PCD SHANK CUTTER FOR HANDLE.
PROFILE N 9

166
PAG.



PROFILE 10 FPS3027

FRESA PER MANIGLIE
PROFILO 10
PCD SHANK CUTTER FOR HANDLE.
PROFILE N 10

166
PAG.



MFX 1 FPS3001

FRESA ALTA PRECISIONE PORTA INSERTI
INTERCAMBIABILI IN DIAMANTE
CON CUSCINETTO COPIA
HIGH PRECISION SHANK CUTTER MULTI-
TASKING WITH INTERCHANGEABLE PRO-
FILED PCD INSERT WITH COPY BEARING

167
PAG.

T-SLOT FPS3008

FRESA T-SLOT IN DIAMANTE PER CAVE PROFILI DI ALLUMINIO Z2+2

PCD T-SLOT BITS FOR ALUMINUM PROFILES Z2+2



Fresa sagomata in diamante per lavorazione cave per profili di alluminio Z2+2 PCD T-SLOT BITS Z2+2 for aluminum profiles.

T-SLOT 1		DIMENSIONI DIMENSIONS		ARTICOLI ITEMS		PREZZI €					
D	D min	LU	DS	LS	LT	Z EFF	Z TOT	B	γ°	DX / RH	PRICE €
DIAMETER	DIAMETER	U. LENGHT	S. DIAM.	S. LENGTH	TOT. LENGTH	A. TEETH	TOT. TEETH			CODICE / SKU	
28,4	11,4	16	20	50	80	2+2	4	8,5	50°	FPS3008001	
30,5	11,7	20	20	50	80	2+2	4	8,3	60°	FPS3008002	

T-SLOT 2		DIMENSIONI DIMENSIONS		ARTICOLI ITEMS		PREZZI €							
D	D min	LU	DS	LS	LT	Z EFF	Z TOT	R1	R2	C	γ°	DX / RH	PRICE €
DIAMETER	DIAMETER	U. LENGHT	S. DIAM.	S. LENGTH	TOT. LENGTH	A. TEETH	TOT. TEETH					CODICE / SKU	
28,50	11,20	16	20	50	80	2+2	4	4	1	14,5	50°	FPS3008003	

T-SLOT 3		DIMENSIONI DIMENSIONS		ARTICOLI ITEMS		PREZZI €								
D	D min	LU	DS	LS	LT	Z EFF	Z TOT	A	B	D2	R1	γ°	DX / RH	PRICE €
DIAMETER	DIAMETER	U. LENGHT	S. DIAM.	S. LENGTH	TOT. LENGTH	A. TEETH	TOT. TEETH						CODICE / SKU	
31,56	11,80	17	20	50	80	2+2	4	12,84	9,5	29,59	0,5	15,66°	FPS3008004	

LAMELLO 3 FPS3009

FRESA DIAMANTE PER GIUNZIONI LAMELLO CLAMEX P-SYSTEM Z1

PCD SHANK CUTTER Z1 FOR LAMELLO CLAMEX P-SYSTEM Z1

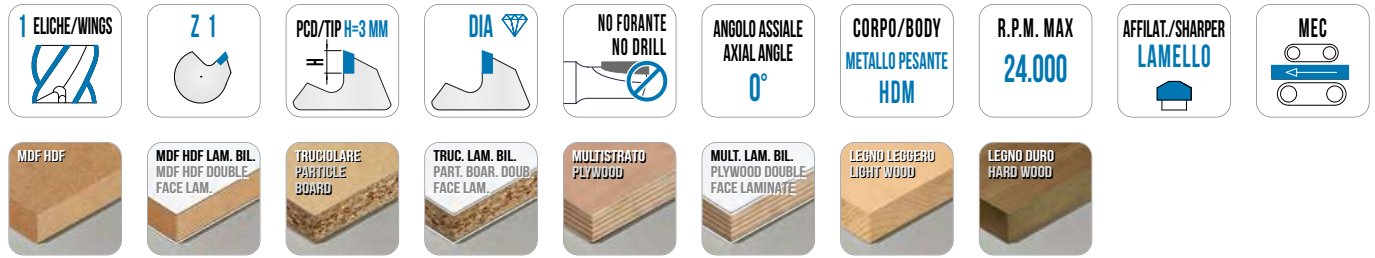

Fresa in diamante Z1 a tagliente dritto per giunzioni lamello clamex P-system. PCD shank cutter Z1 for lamello clamex P-system Z1.

DIMENSIONI		DIMENSIONS		ARTICOLI		ITEMS		PREZZI €	
D	D min	LU	DS	LS	LT	β°	Z EFF	DX / RH	PRICE €
DIAMETER	DIAMETER	U. LENGHT	S. DIAM.	S. LENGTH	TOT. LENGTH		A. TEETH	CODICE / SKU	
10	7,4	18	12	50	78	0°	1	FPS3009001	

LAMELLO 4 FPS3501

FRESA IN HW NEGATIVA Z2 PER GIUNZIONI LAMELLO CLAMEX P-SYSTEM

HW SHANK CUTTER Z2 NEGATIVE FOR LAMELLO CLAMEX P-SYSTEM



Fresa in HW Z2 NEG per giunzioni lamello clamex P-system. HW shank cutter Z2 negative for lamello clamex P-system.

DIMENSIONI		DIMENSIONS		ARTICOLI		ITEMS		PREZZI €	
D	D min	LU	DS	LS	LT	β°	Z EFF	DX / RH	PRICE €
DIAMETER	DIAMETER	U. LENGHT	S. DIAM.	S. LENGTH	TOT. LENGTH		A. TEETH	CODICE / SKU	
10	7,4	18	12	50	78	10°	2	FPS3501001	

LAMELLO 6 - FRESA LAMELLO PER NESTING NEXTEC FPS3030

NEW

FRESA DIAMANTE NESTING PER GIUNZIONI LAMELLO CLAMEX P-SYSTEM

SHANK CUTTER FOR LAMELLO CLAMEX P-SYSTEM JUNCTIONS ON NESTING



Fresa in PCD Z2 nesting per giunzioni lamello clamex P-system ideale per macchina NEXTEC Clamex P System.

PCD shank cutter Z2 for lamello clamex P-SYSTEM suitable for NEXTEC Clamex P System machine.

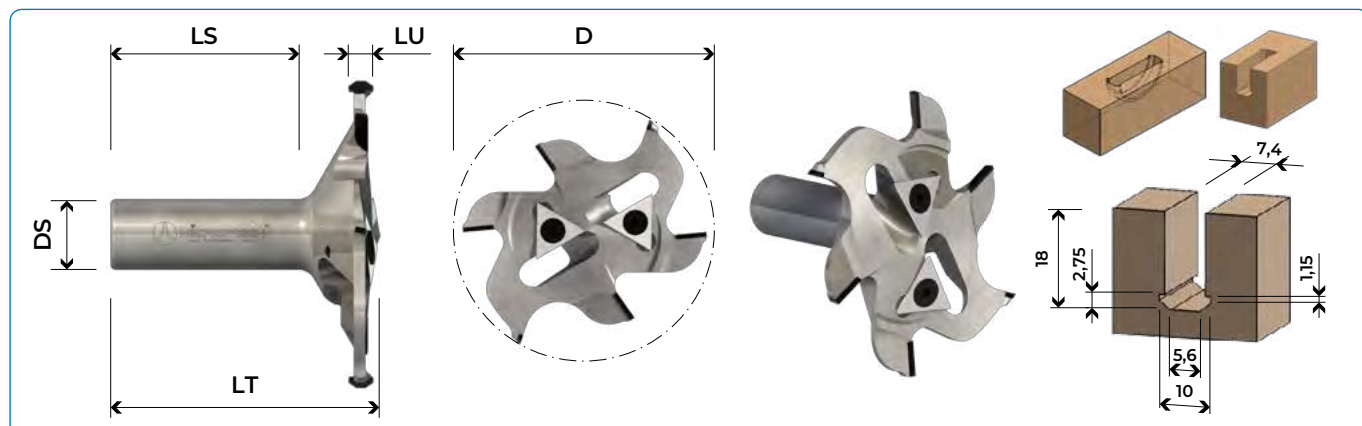

DIMENSIONI DIMENSIONS		ARTICOLI ITEMS		PREZZI €			
D DIAMETER	LU U. LENGHT	DS S. DIAM.	LS S. LENGHT	LT TOT. LENGHT	Z EFF A. TEETH	DX / RH CODICE / SKU	PRICE €
100,4	7	20	50	76	2	FPS3030001 NEW	



JOINT CUT 1 FPS30 10

FRESA DA PANTOGRAFO IN DIAMANTE PER GIUNZIONI

PCD FINGER JOINT SHANK CUTTER



Fresa da pantografo in diamante per giunzioni di legni teneri e duri lungo vena.

PCD diamond tools for cutting longitudinal joints for dimensionally stable construction part round arched joint.

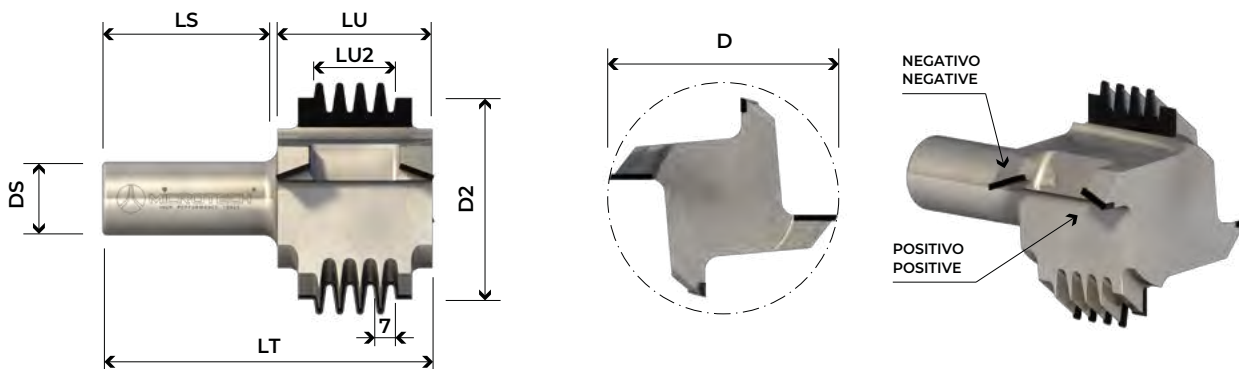

DIMENSIONI DIMENSIONS

ARTICOLI ITEMS

PREZZI €

D	D2	C	LU2	N°V	DS	LS	LT	Z EFF	Z TOT	PROFILO	DX / RH	PREZZI €
DIAMETER	DIAMETER		U. LENGHT		S. DIAM.	S. LENGHT	T. LENGHT	A. TEETH	TOT. TEETH	PROFILE	CODICE / SKU	PRICE €
80	70	53	28	4	20	50	108	2+2	6	A1	FPS3010001	
80	70	53	28	4	50	50	108	2+2	6	A2	FPS3010002	
80	70	45	21	3	20	50	100	2+2	6	B1	FPS3010003	
80	70	45	21	3	20	50	100	2+2	6	B2	FPS3010004	
80	70	38	14	2	20	50	93	2+2	6	C1	FPS3010005	
80	70	38	14	2	20	50	93	2+2	6	C2	FPS3010006	
80	70	53	28	4	25	55	113	2+2	6	A1	FPS3010007	
80	70	53	28	4	25	55	113	2+2	6	A2	FPS3010008	
80	70	45	21	3	25	55	105	2+2	6	B1	FPS3010009	
80	70	45	21	3	25	55	105	2+2	6	B2	FPS3010010	
80	70	38	14	2	25	55	98	2+2	6	C1	FPS3010011	
80	70	38	14	2	25	55	98	2+2	6	C2	FPS3010012	

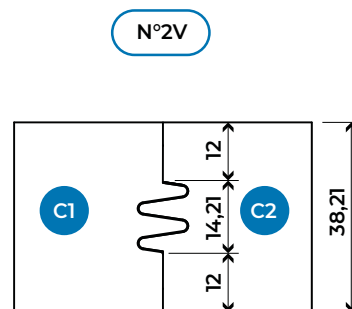
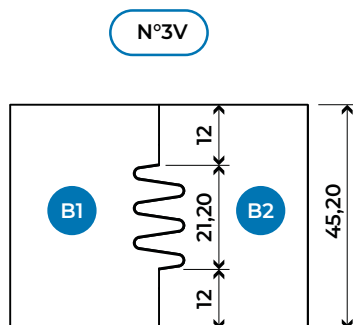
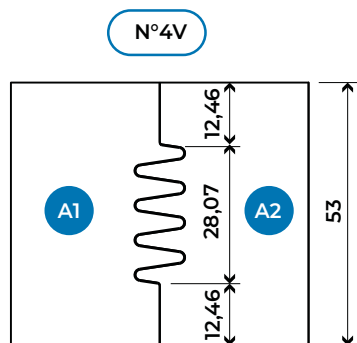

V CUT 1 VGROOVE 90° FPS3011

FRESA CONICA IN DIAMANTE PER CANALI A V FOLDING E SMUSSI A 45° Z2

PCD "V" GROOVING AND FOR CHAMFERING AT 45° Z2



Fresa conica in diamante per canali a "V" e smussi a 45°. Corpo in acciaio. PCD Z2 H4,5mm riaffilabile per una lunga durata e per garantire una finitura perfetta su MDF, HDF, truciolare, multistrato, legno tenero, corian, plexiglass, fibrogesso e fibrocemento.

Suitable for "V" Grooving, bevelling and chamfering at 45°. Steel body and PCD shank cutter Z2 H4,5mm resharpened for long life and to ensure a perfect finish on MDF, HDF, particle board, plywood, light wood, corian, plexiglass, plaster fiber e fiber cement.

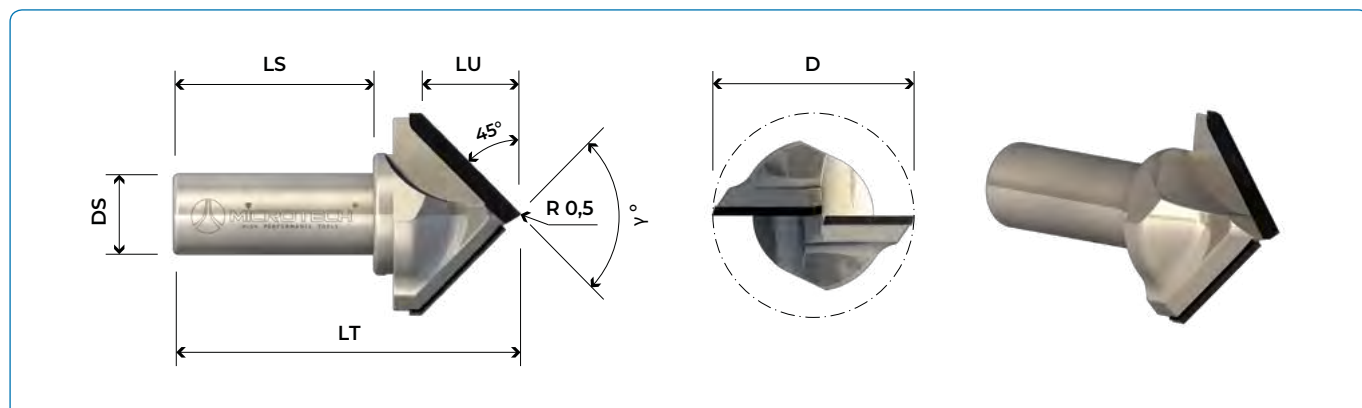

DIMENSIONI DIMENSIONS				ARTICOLI ITEMS		PREZZI €			
D	LU	Z EFF	γ°	DS	LS	LT	SX / LH	DX / RH	PRICE €
DIAMETER	USEFUL LENGHT	ACTUAL TEETH		SHANK DIAMETER	SHANK LENGTH	TOTAL LENGTH	CODICE / SKU	CODICE / SKU	
16	8	2	90°	8	40	60	FPS3011023	FPS3011024	
16	8	2	90°	12	40	60	FPS3011001	FPS3011002	
16	8	2	90°	20	50	70	FPS3011003	FPS3011004	
25	12,5	2	90°	12	40	65	FPS3011005	FPS3011006	
25	12,5	2	90°	20	50	75	FPS3011007	FPS3011008	
35	17,5	2	90°	20	50	80	FPS3011009	FPS3011010	
45	22,5	2	90°	20	50	88	FPS3011011	FPS3011012	
55	27,5	2	90°	20	50	93	FPS3011013	FPS3011014	
65	32,5	2	90°	20	50	98	FPS3011015	FPS3011016	
65	32,5	2	90°	25	55	103	FPS3011017	FPS3011018	
85	42,5	2	90°	20	50	108	FPS3011019	FPS3011020	
85	42,5	2	90°	25	55	113	FPS3011021	FPS3011022	

V CUT 2 VGROVE 90° Z1+1 FPS3012

FRESA CONICA IN DIAMANTE PER CANALI A V FOLDING E SMUSSI A 45° Z1+1

PCD "V" FOLDING GROOVING AND FOR CHAMFERING AT 45° Z1+1



Fresa conica in diamante per canali a "V" e smussi a 45°. Corpo in acciaio. PCD Z1+1 H4,5mm riaffilabile per una lunga durata e per garantire una finitura perfetta su MDF, HDF, truciolare, multistrato, legno tenero, corian, plexiglass, fibrogesso e fibrocemento.

Suitable for "V" Grooving, bevelling and chamfering at 45°. Steel body and PCD shank cutter Z1+1 H4,5mm resharpened for long life and to ensure a perfect finish on MDF, HDF, particle board, plywood, light wood, corian, plexiglass, plaster fiber e fiber cement.

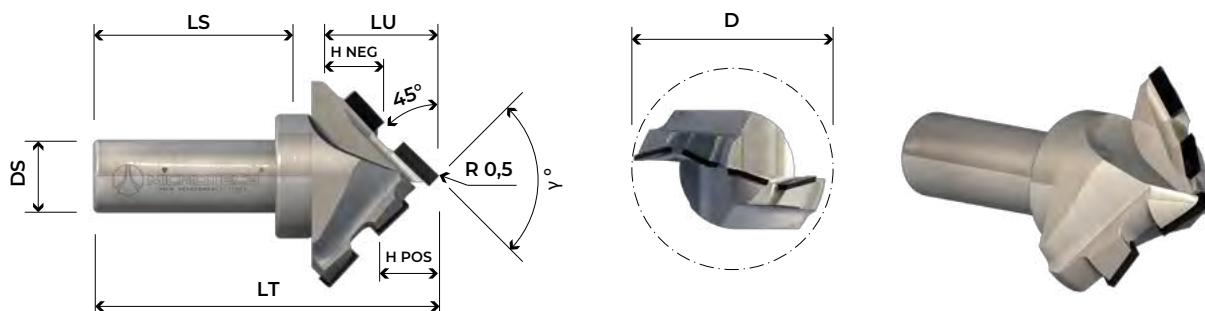

DIMENSIONI DIMENSIONS							ARTICOLI ITEMS		PREZZI €			
D	LU	Z EFF	Z TOT	H	H	γ°	DS	LS	LT	SX / LH	DX / RH	PRICE €
DIAM.	USEFUL LENGHT	A. TEETH	TOT. TEETH	POS	NEG		SHANK DIAMETER	SHANK LENGTH	TOTAL LENGTH	CODICE / SKU	CODICE / SKU	
45	22,5	1+1	3	17	5,5	90°	12	40	78	FPS3012001	FPS3012002	
45	22,5	1+1	3	17	5,5	90°	20	50	88	FPS3012003	FPS3012004	
57	28,5	1+1	4	17	11,5	90°	12	40	84	FPS3012005	FPS3012006	
57	28,5	1+1	4	17	11,5	90°	20	50	94	FPS3012007	FPS3012008	
70	35	1+1	5	17	18	90°	20	50	100	FPS3012009	FPS3012010	
70	35	1+1	5	17	18	90°	25	55	105	FPS3012011	FPS3012012	
94	47	1+1	7	17	30	90°	20	50	112	FPS3012013	FPS3012014	
94	47	1+1	7	17	30	90°	25	55	117	FPS3012015	FPS3012016	

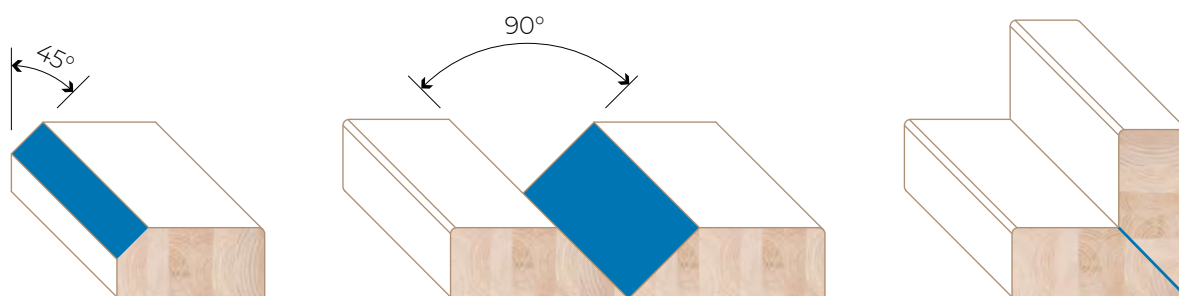

V CUT 3 VGROVE 90° Z2+2 FPS3013

FRESA CONICA IN DIAMANTE PER CANALI A V FOLDING E SMUSSI A 45° Z2+2

PCD "V" FOLDING GROOVING AND FOR CHAMFERING AT 45° Z2+2



Fresa conica in diamante per canali a "V" e smussi a 45°. Corpo in acciaio. PCD Z2+2 H4,5mm riaffilabile per una lunga durata e per garantire una finitura perfetta su MDF, HDF, truciolare, multistrato, legno tenero, corian, plexiglass, fibrogesso e fibrocemento.

Suitable for "V" Grooving, bevelling and chamfering at 45°. Steel body and PCD shank cutter Z2+2 H4,5mm resharpened for long life and to ensure a perfect finish on MDF, HDF, particle board, plywood, light wood, corian, plexiglass, plaster fiber e fiber cement.

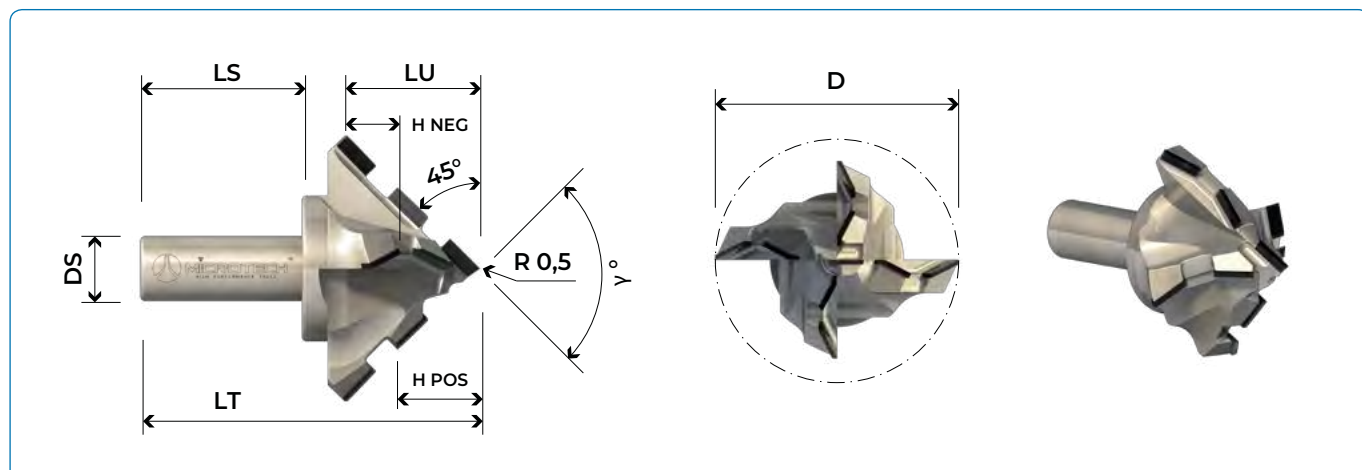

DIMENSIONI DIMENSIONS								ARTICOLI ITEMS		PREZZI €		
D DIAM.	LU USEFUL LENGTH	Z EFF A. TEETH	Z TOT TOT. TEETH	H POS	H NEG	γ°	DS SHANK DIAMETER	LS SHANK LENGTH	LT TOTAL LENGTH	SX / LH CODICE / SKU	DX / RH CODICE / SKU	PRICE €
45	22,5	2+2	5	17	5,5	90°	12	40	78	FPS3013001	FPS3013002	
45	22,5	2+2	5	17	5,5	90°	20	50	88	FPS3013003	FPS3013004	
57	28,5	2+2	7	17	11,5	90°	12	40	84	FPS3013005	FPS3013006	
57	28,5	2+2	7	17	11,5	90°	20	50	94	FPS3013007	FPS3013008	
70	35	2+2	9	17	18	90°	20	50	100	FPS3013009	FPS3013010	
70	35	2+2	9	17	18	90°	25	55	105	FPS3013011	FPS3013012	
94	47	2+2	13	17	30	90°	20	50	112	FPS3013013	FPS3013014	
94	47	2+2	13	17	30	90°	25	55	117	FPS3013015	FPS3013016	

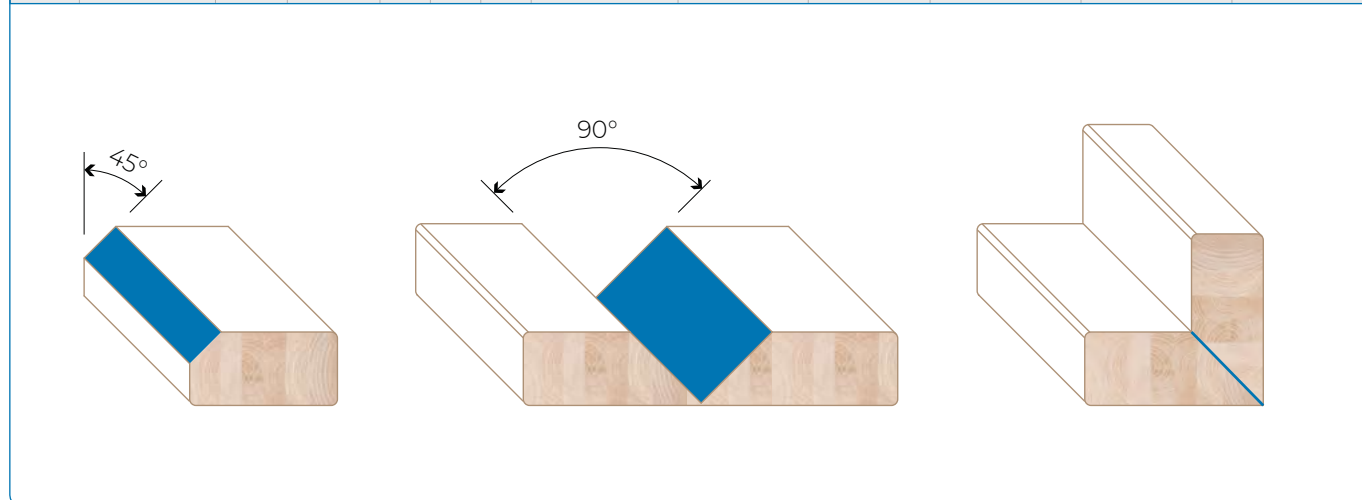

V CUT 7 - FRESA A COLTELLINI PER SMUSSARE FPS3504

NEW

FRESA A COLTELLINI REVERSIBILI IN HW PER SMUSSARE
SHANK CUTTER WITH HW INSERT KNIFE FOR CHAMFERING

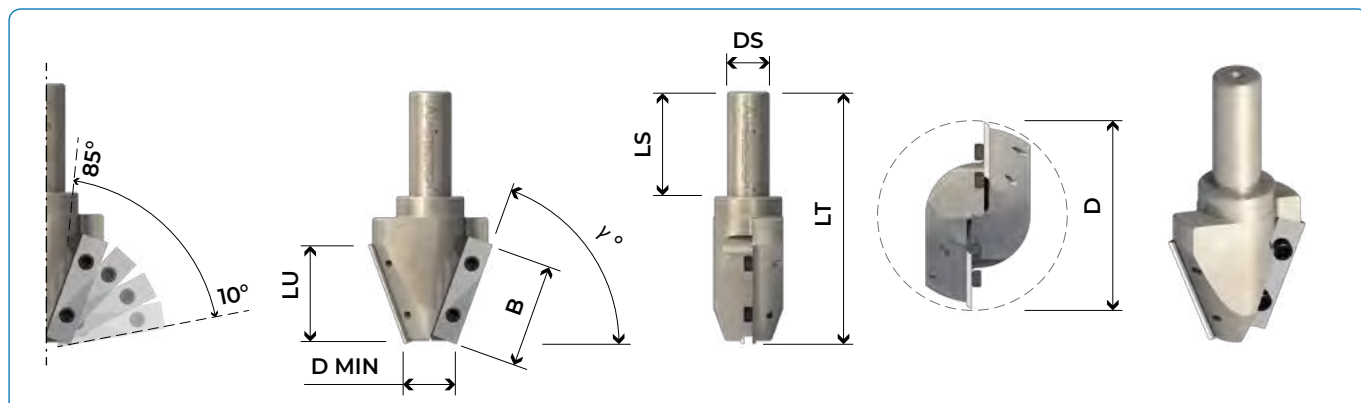

DIMENSIONI DIMENSIONS									ARTICOLI ITEMS		PREZZI €
D	D min	LU	DS	LS	LT	B	γ°	Z EFF	SX / LH	DX / RH	PRICE €
DIAMETER	DIAMETER	U. LENGHT	S. DIAM.	S. LENGTH	T. LENGTH		A. ANGLE	A. TEETH	CODICE / SKU	CODICE / SKU	
38,7	30	49,7	20	50	125	50	85	2	FPS3504001	FPS3504002	
42,4	25	49,2	20	50	125	50	80	2	FPS3504003	FPS3504004	
50,9	25	48,2	20	50	120	50	75	2	FPS3504005	FPS3504006	
59,2	25	47	20	50	120	50	70	2	FPS3504007	FPS3504008	
64,2	22	45,3	20	50	120	50	65	2	FPS3504009	FPS3504010	
71,9	22	43,3	20	50	120	50	60	2	FPS3504011	FPS3504012	
79,3	22	40,9	20	50	115	50	55	2	FPS3504013	FPS3504014	
86,2	22	38,2	20	50	115	50	50	2	FPS3504015	FPS3504016	
85,5	15	35,2	20	50	110	50	45	2	FPS3504017	FPS3504018	
91,6	15	32	25	55	110	50	40	2	FPS3504019	FPS3504020	
96,9	15	28,6	25	55	110	50	35	2	FPS3504021	FPS3504022	
101,3	15	25	25	55	110	50	30	2	FPS3504023	FPS3504024	
105,6	15	21,1	25	55	110	50	25	2	FPS3504025	FPS3504026	
108,6	15	17	25	55	95	50	20	2	FPS3504027	FPS3504028	
108,5	12	12,9	25	55	95	50	15	2	FPS3504029	FPS3504030	
109,9	12	8,6	25	55	95	50	10	2	FPS3504031	FPS3504032	

RICAMBI PARTS								
INSERTO INSERT	ARTICOLO ITEM	PREZZO PRICE	VITE ALLEN SCREW	ARTICOLO ITEM	PREZZO PRICE	CHIAVE ZEY	ARTICOLO ITEM	PREZZO PRICE
	50x12x1,5 35° RIC9008011			M4X6x8,2 (T15) RIC9007055			CHIAVE TORX T15 RIC9013012	

V CUT 6 - FRESA DIAMANTE PER SMUSSI 45° FPS3033

NEW

FRESA CONICA PER SMUSSI A 90° Z2+2 ASSIALE POS NEG

PCD V SHANK CUTTER Z 2+2 POSITIVE AND NEGATIVE AXIAL CUT

Fresa conica in PCD per smussi a 45°. Corpo in acciaio. PCD Z2+2 frazionto positivo negativo H4,5mm riaffilabile 8 volte. Ottime prestazioni e finitura su su MDF, HDF, truciolare, multistrato, legno tenero, legno duro.

Suitable for chamfering at 45°. Steel body and Z2+2 PCD H4,5mm resharpened for long life and to ensure a perfect finish on MDF, HDF, particle board, plywood, light wood, hard wood.

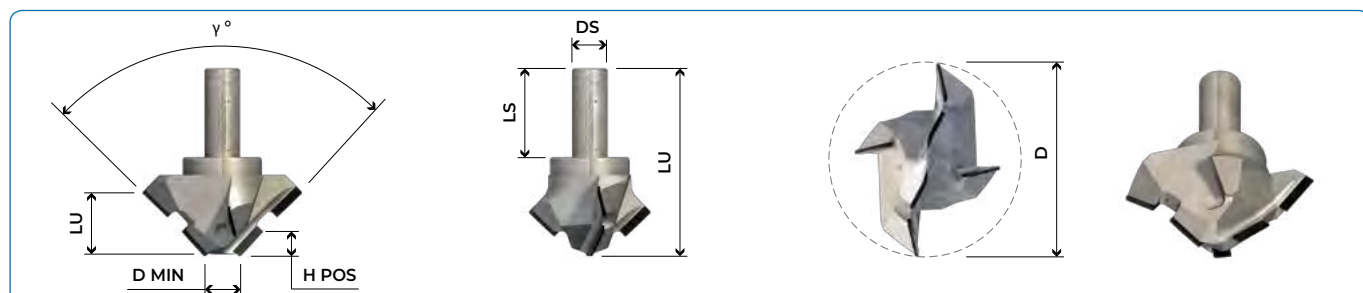

DIMENSIONI		DIMENSIONS		ARTICOLI		ITEMS		PREZZI €					
D	D min	LU	DS	LS	LT	H POS	H NEG	γ°	Z EFF	Z TOT	SX / LH	DX / RH	PRICE €
DIAMETER	DIAMETER	U. LENGTH	S. DIAM.	S. LENGTH	T. LENGTH	H POS	H NEG	A. ANGLE	A. TEETH	TOT. TEETH	CODICE / SKU	CODICE / SKU	
60	10	25	20	50	95	15	10	90°	2	4	FPS3033001	FPS3033002	
90	20	35	20	50	105	14	21	90°	2	6	FPS3033003	FPS3033004	

RADIUS 5 - FRESA SFERICA IN DIAMANTE FPS3034

NEW

FRESA SFERICA IN DIAMANTE PER LAVORAZIONE SUPERFICI

SPHERICAL SHANK CUTTER IN DIAMOND FOR PANEL SURFACE

SPHERICAL SHANK CUTTER IN DIAMOND FOR PANEL SURFACE

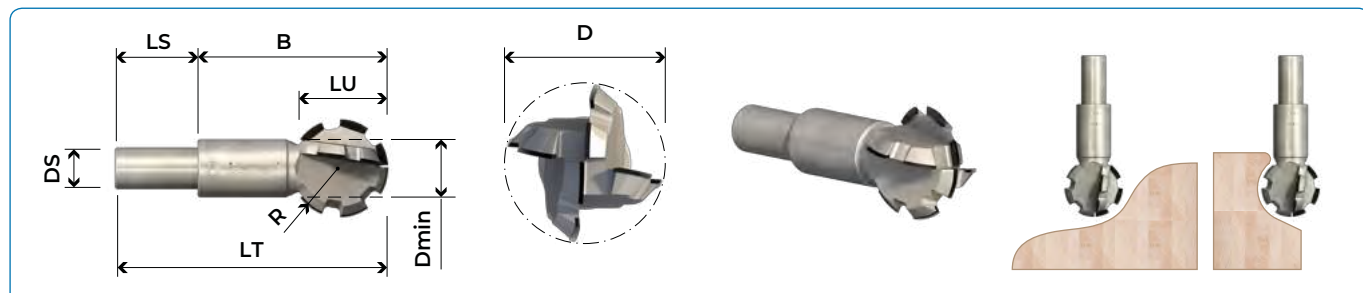

DIMENSIONI		DIMENSIONS		ARTICOLI		ITEMS		PREZZI €				
D	D min	LU	DS	LS	LT	Z EFF	Z TOT	B	R	SX / LH	DX / RH	PRICE €
DIAMETER	DIAMETER	U. LENGTH	S. DIAM.	S. LENGTH	TOT. LENGTH	A. TEETH	TOT. TEETH			CODICE / SKU	CODICE / SKU	
40	23	35	25	50	160	2	10	92	20	FPS3034001	FPS3034002	
50	32	43	25	55	110	2	10	60	25	FPS3034003	FPS3034004	
60	35	52	25	55	165	2	10	114	30	FPS3034005	FPS3034006	
80	57	68	25	60	135	2	10	75	40	FPS3034007	FPS3034008	

VARIO 3 - FRESA ORIENTABILE A COLTELLINI 90° FPS3502

NEW

FRESA ORIENTABILE CON COLTELLINO REVERSIBILE IN HW

ADJUSTABLE CUTTER WITH INTERCHANGEABLE HW KNIFE

Fresa per inserti in widia orientabili z2. Adatta per smussi di varie angolazioni su legni, truciolari, mdf e altri materiali. L'angolo dello smusso può essere regolato gradualmente utilizzando una scala graduata. È possibile una regolazione di 1°. Adatta per uso su centri di lavoro con controllo CNC.

Disposable insert router cutter complete with two cutting flutes z2. Suitable for producing chamfer cuts at various angles in softwood, hardwood and other materials. Cutting angle can be adjusted steps by using a notched scale. Fine adjustment of 1° is also possible. For use on machining centers with CNC control.

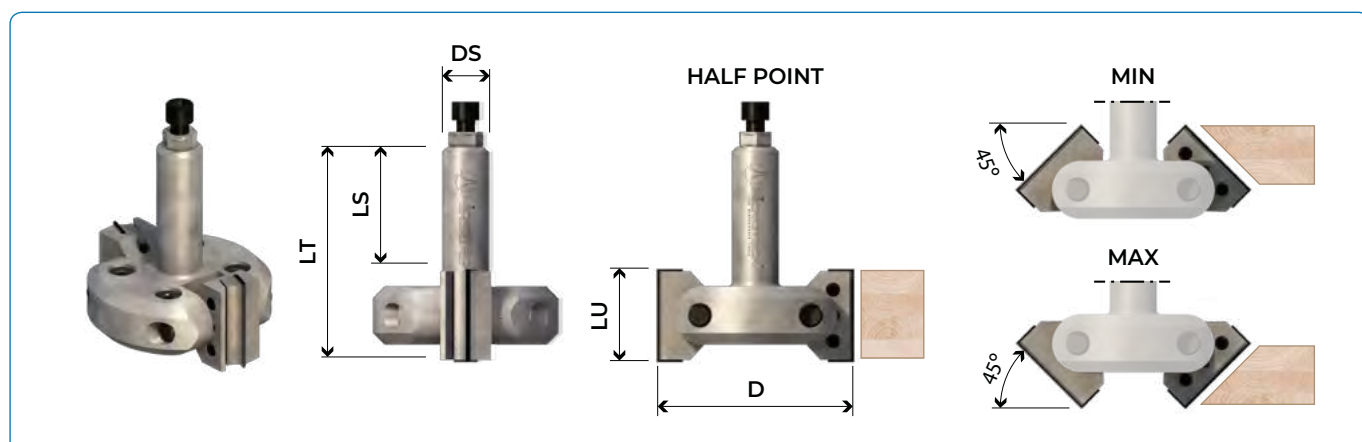

DIMENSIONI		DIMENSIONS		ARTICOLI		ITEMS		PREZZI €
D	LU	DS	LS	LT	Z EFF	DX / RH		PRICE €
DIAMETER	U. LENGHT	S. DIAM.	S. LENGTH	TOT. LENGTH	A. TEETH	CODICE / SKU		
85	40	20	50	92	2	FPS3502001	NEW	
110	50	20	50	110	2	FPS3502002	NEW	

RICAMBI PARTS								
	ARTICOLO	PREZZO	ARTICOLO	PREZZO	ARTICOLO	PREZZO	ARTICOLO	PREZZO
	ITEM	PRICE	ITEM	PRICE	ITEM	PRICE	ITEM	PRICE
	INSERTO		CUNEO		FISS. CUNEO		VITE	
	INSERT		WEDGE		LOCKING WEDGE		ALLEN SCREW	
LU40	40X12X1.5 RIC9020004		L=38 RIC3502001		25X12 RIC3502001		M6X6X8 RIC9007129	
LU50	50X12X1.5 RIC9020005		L=48 RIC3532002		25X12 RIC3502001		M6X6X8 RIC9007129	

RICAMBI PARTS								
	ARTICOLO	PREZZO	ARTICOLO	PREZZO	ARTICOLO	PREZZO	ARTICOLO	PREZZO
	ITEM	PRICE	ITEM	PRICE	ITEM	PRICE	ITEM	PRICE
	VITE		CHIAVE		CHIAVE			
	ALLEN SCREW		ALLEN KEY		ALLEN KEY			
LU40	M5X15 RIC9007062		S3 RIC9013006		S4 RIC9013007			
LU50	M5X15 RIC9007062		S3 RIC9013006		S4 RIC9013007			

VARIO 2 - FRESA ORIENTABILE A COLTELLINI 135° FPS3503

NEW

FRESA ORIENTABILE CON COLTELLINO REVERSIBILE IN HW

ADJUSTABLE CUTTER WITH INTERCHANGEABLE HW KNIFE

Fresa per inserti in widia orientabili z2. Adatta per smussi di varie angolazioni su legni, truciolari, mdf e altri materiali. L'angolo dello smusso può essere regolato gradualmente utilizzando una scala graduata. Adatta per uso su centri di lavoro con controllo CNC.

Disposable insert router cutter complete with two cutting flutes z2. Suitable for producing chamfer cuts at various angles in softwood, hardwood and other materials. Cutting angle can be adjusted steps by using a notched scale. For use on machining centers with CNC control.

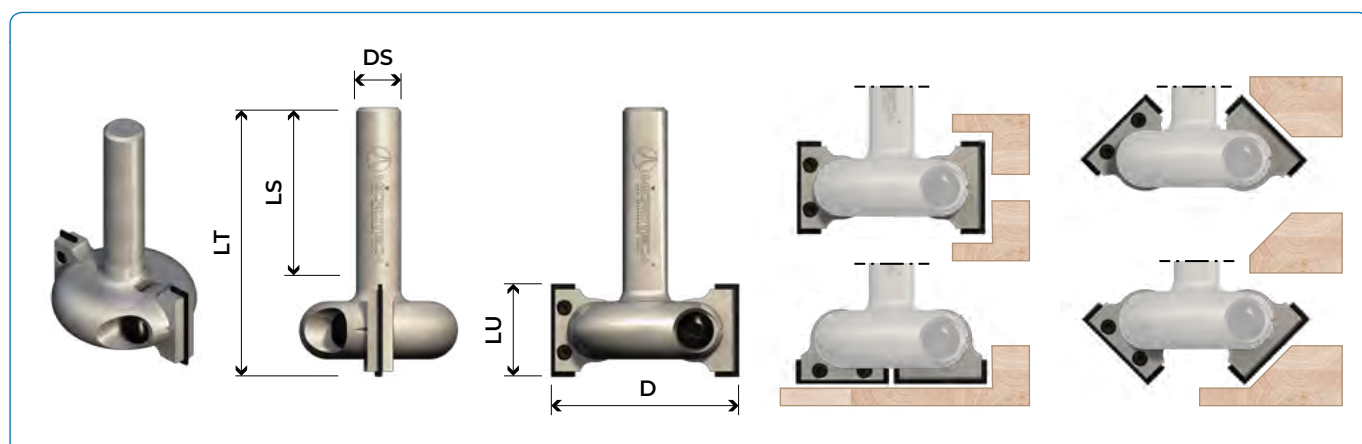

DIMENSIONI DIMENSIONS					ARTICOLI ITEMS	PREZZI €
D	LU	DS	LS	LT	Z EFF	DX / RH
DIAMETER	U. LENGHT	S. DIAM.	S. LENGTH	TOT. LENGTH	A. TEETH	CODICE / SKU
50,47	25	12	45	72	2	FPS3503001 NEW

RICAMBI PARTS							
ARTICOLO ITEM	PREZZO PRICE	ARTICOLO ITEM	PREZZO PRICE	ARTICOLO ITEM	PREZZO PRICE	ARTICOLO ITEM	PREZZO PRICE
INSERTO INSERT 25X6.5X1.1 RIC9026004		VITE ALLEN SCREW M4X3 RIC9007011		CHIAVE KEY S3 RIC9013006		CHIAVE KEY S4 RIC9013007	

V CUT 4 - VGROVE 90° DIBOND FPS3014

FRESA CONICA IN DIAMANTE PER CANALI A V FOLDING A 45° Z2 PER DIBOND

PCD "V" GROOVING SHANK CUTTER AT 45° FOR FOLDING OPERATION Z2 USED ON DIBOND



Fresa conica in diamante policristallino Z2 per lavorazione a V di pannelli di Alucobond o Dibond e materiali similari.

Double Edge Folding V-Groove pcd diamond Router Bits for Shaping Aluminum Composite Material (ACM) such as Alucobond®, Dibond® and other brands a like.

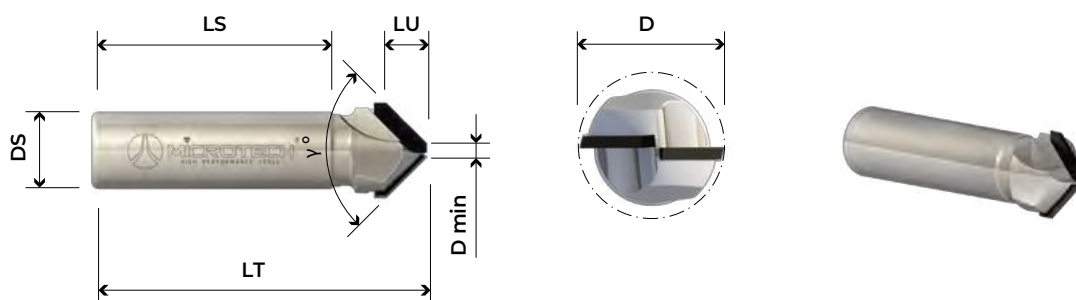

DIMENSIONI		DIMENSIONS			ARTICOLI			ITEMS		PREZZI €
D	D min	LU	Z EFF	γ°	DS	LS	LT	DX / RH		PRICE €
DIAMETER	DIAMETER	USEFUL LENGHT	A. TEETH		SHANK DIAMETER	SHANK LENGTH	TOTAL LENGTH	CODICE / SKU		
20	3	8,5	2	90°	16	50	70	FPS3014001		

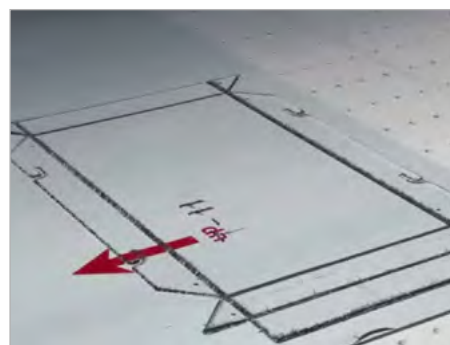
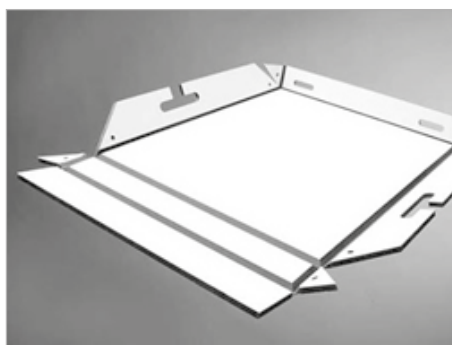
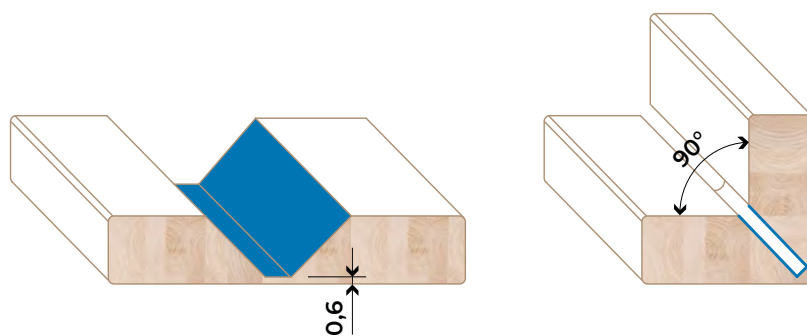

V CUT 5 VGROVE 60° FPS3015

FRESA CONICA IN DIAMANTE PER CANALI A V FOLDING E SMUSSI A 60° E FINITURE INTERNE AGLI ANGOLI A 90° Z2
 PCD "V" GROOVING SHANK CUTTER AT 60° FOR FOLDING AND CHAMFERING OPERATIONS Z2 AND 90° FOR INSIDE ANGLES



Fresa conica in diamante 60° per cave a V, smussi laterali su pannelli e finitura di angoli interni a 90°.

PCD "V" Grooving shank cutter Z2 60° conical for chamfering operations and 90° inside angles.

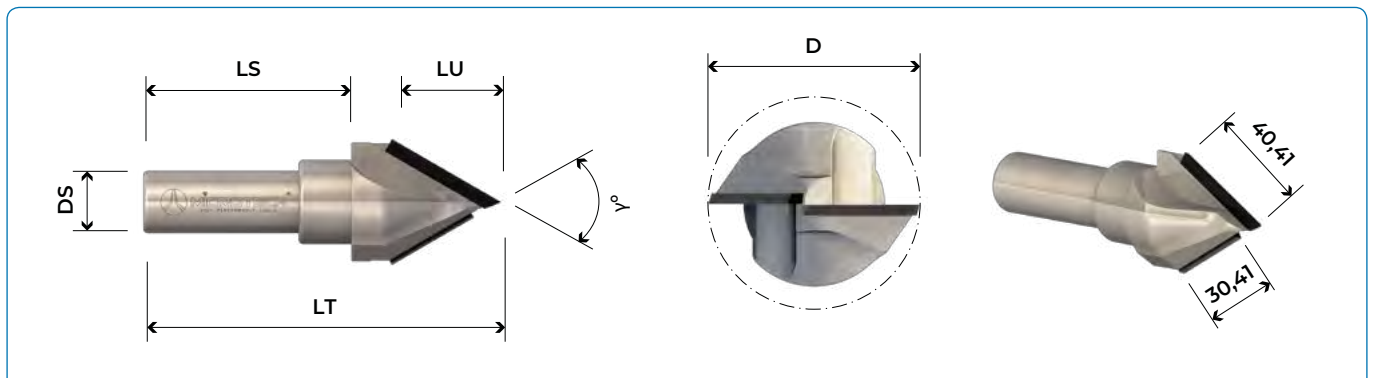

DIMENSIONI DIMENSIONS				ARTICOLI ITEMS		PREZZI €		
D	LU	Z EFF	γ°	DS	LS	LT	DX / RH	PRICE €
DIAMETER	USEFUL LENGHT	A. TEETH		SHANK DIAMETER	SHANK LENGTH	TOTAL LENGTH	CODICE / SKU	
40	35	2	60°	20	50	115	FPS3015001	

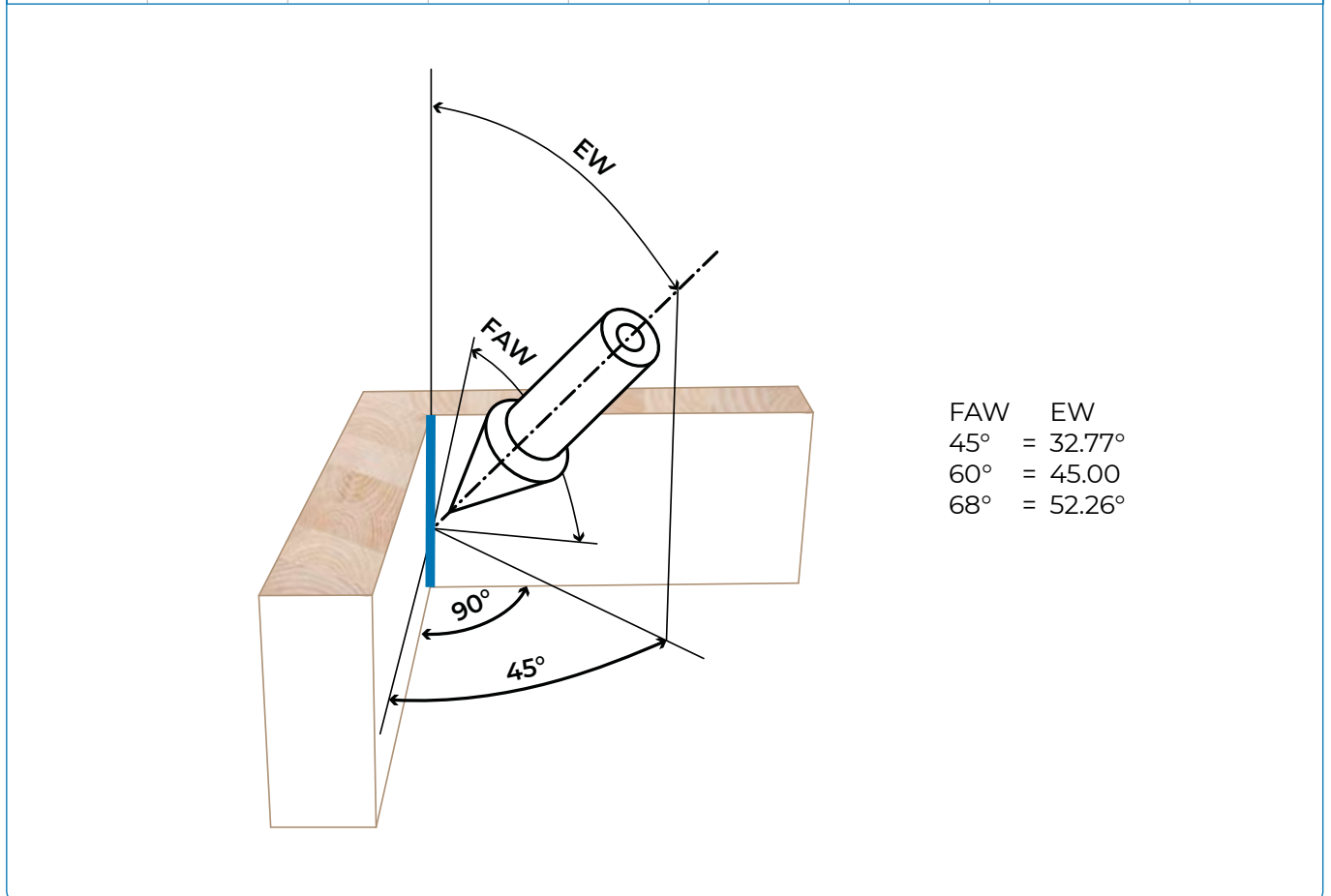

FAW	EW
45°	= 32.77°
60°	= 45.00
68°	= 52.26°

RADIUS 1 FPS3016

FRESA SFERICA IN DIAMANTE Z2

PCD BALL NOSE SHANK CUTTER Z2

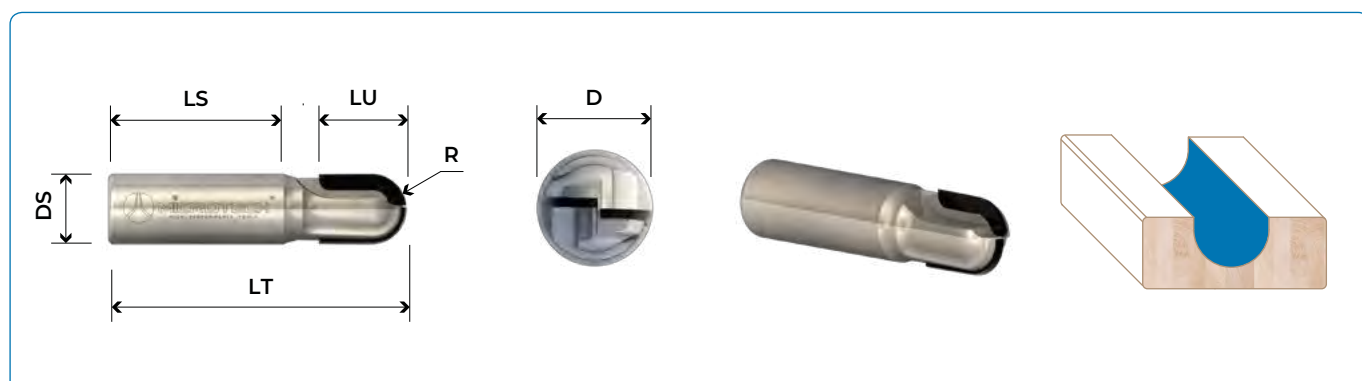

DIMENSIONI		DIMENSIONS		ARTICOLI		ITEMS		PREZZI €		
D	LU	Z EFF	R	H PCD	DS	LS	LT	SX / LH	DX / RH	PRICE €
DIAMETER	U. LENGHT	A. TEETH	RADIUS	PCD HEIGHT	S. DIAM.	S. LENGTH	TOT. LENGTH	CODICE / SKU	CODICE / SKU	
6	6	1	3	3	12	40	56	FPS3016001	FPS3016002	
6,35	6,35	2	3,175	3	12,7	40	56	FPS3016003	FPS3016004	
8	8	2	4	3	12	40	60	FPS3016005	FPS3016006	
9,5	9,5	2	4,75	3	12,7	40	62	FPS3016007	FPS3016008	
10	10	2	5	3	12	40	62	FPS3016009	FPS3016010	
12	12	2	6	3	12	40	64	FPS3016011	FPS3016012	
12,7	12,7	2	6,35	3	12	40	65	FPS3016013	FPS3016014	
12,7	12,7	2	6,35	3	12,7	40	65	FPS3016015	FPS3016016	
14	14	2	7	3	20	50	76	FPS3016017	FPS3016018	
16	16	2	8	3	20	50	81	FPS3016019	FPS3016020	
18	18	2	9	4	20	50	83	FPS3016021	FPS3016022	
20	20	2	10	4	20	50	85	FPS3016023	FPS3016024	
20	30	2	10	4	20	50	95	FPS3016025	FPS3016026	
20	30	2	10	4	20	50	110	FPS3016027	FPS3016028	
20	30	2	10	4	20	50	130	FPS3016029	FPS3016030	
25	25	2	12,5	5	20	50	90	FPS3016031	FPS3016032	
25	25	2	12,5	5	25	55	95	FPS3016033	FPS3016034	
30	30	2	15	5	20	50	95	FPS3016035	FPS3016036	
30	30	2	15	5	25	55	100	FPS3016037	FPS3016038	
40	40	2	20	5	20	50	105	FPS3016039	FPS3016040	
40	40	2	20	5	25	55	110	FPS3016041	FPS3016042	

RADIUS 2 FPS3017

FRESA IN DIAMANTE A RAGGIO CONCAVO Z2

PCD QUARTER ROUND SHANK CUTTER Z 2

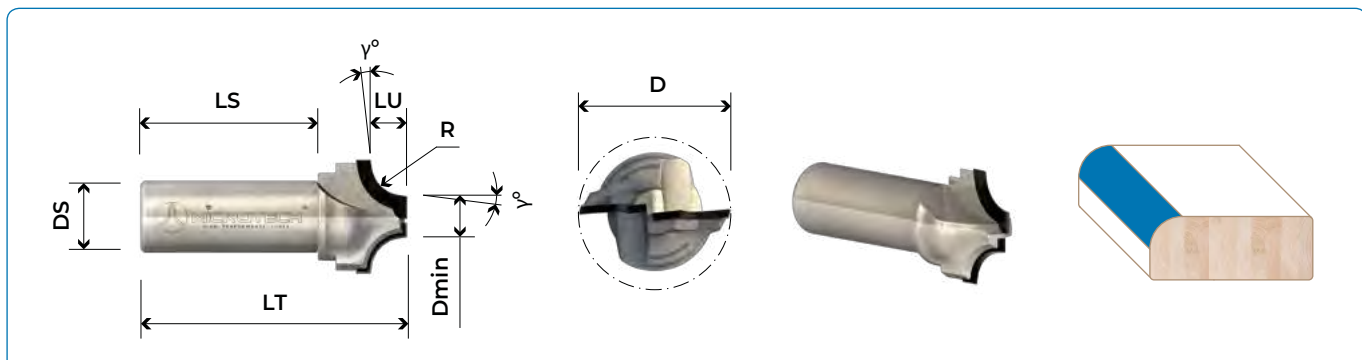
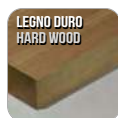
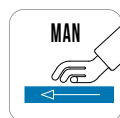
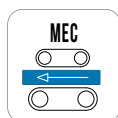

DIMENSIONI DIMENSIONS ARTICOLI ITEMS PREZZI €

R	D	D min	LU	Z EFF	H PCD	β°	γ°	DS	LS	LT	SX / LH	DX / RH	PRICE €
RADIUS	DIAMETER	DIAMETER	U. LENGTH	A. TEETH	PCD HEIGHT			SHANK DIAM.	S. LENGTH	TOT. LENGTH	CODICE / SKU	CODICE / SKU	
1	16	10	3	2	3	5°	8°	12	40	55	FPS3017001	FPS3017002	
1,5	17	10	3,5	2	3	5°	8°	12	40	56	FPS3017003	FPS3017004	
2	18	10	4	2	3	5°	8°	12	40	56	FPS3017005	FPS3017006	
2,5	19	10	4,5	2	3	5°	8°	12	40	57	FPS3017007	FPS3017008	
3	20	10	5	2	3	5°	8°	12	40	57	FPS3017009	FPS3017010	
3,2	20,4	10	5,2	2	3	5°	8°	12,7	40	57	FPS3017011	FPS3017012	
4	22	10	6	2	3	5°	8°	12	40	58	FPS3017013	FPS3017014	
4,75	23,5	10	6,75	2	4	5°	8°	12,7	40	59	FPS3017015	FPS3017016	
5	24	10	7	2	4	5°	8°	12	40	59	FPS3017017	FPS3017018	
6	26	10	8	2	4	5°	8°	12	40	60	FPS3017019	FPS3017020	
6,35	26,7	10	8,35	2	4	5°	8°	12,7	50	70	FPS3017021	FPS3017022	
8	30	10	10	2	4	5°	8°	12	40	62	FPS3017023	FPS3017024	
9,5	33	10	11,5	2	4	5°	8°	12,7	40	64	FPS3017025	FPS3017026	
10	35	10	12,5	2	4	5°	8°	20	50	75	FPS3017027	FPS3017028	
12	44	15	14,5	2	4	5°	8°	20	50	77	FPS3017029	FPS3017030	
12,7	45,4	15	15,2	2	4	5°	8°	19,05	50	77	FPS3017031	FPS3017032	
13	46	15	15,5	2	4	5°	8°	20	50	78	FPS3017033	FPS3017034	
14	48	15	16,5	2	4	5°	8°	20	50	79	FPS3017035	FPS3017036	
15	50	15	17,5	2	5	5°	8°	20	50	80	FPS3017037	FPS3017038	
16	52	15	18,5	2	5	5°	8°	20	50	81	FPS3017039	FPS3017040	
17	54	15	19,5	2	5	5°	8°	20	50	82	FPS3017041	FPS3017042	
18	56	15	20,5	2	5	5°	8°	20	50	83	FPS3017043	FPS3017044	
19	58	15	21,5	2	5	5°	8°	20	50	84	FPS3017045	FPS3017046	
20	65	20	22,5	2	5	5°	8°	20	50	85	FPS3017047	FPS3017048	
21	67	20	23,5	2	5	5°	8°	20	50	86	FPS3017049	FPS3017050	
22	69	20	24,5	2	5	5°	8°	20	50	87	FPS3017051	FPS3017052	
23	71	20	25,5	2	5	5°	8°	20	50	88	FPS3017053	FPS3017054	
24	73	20	26,5	2	5	5°	8°	20	50	89	FPS3017055	FPS3017056	
25	75	20	27,5	2	5	5°	8°	20	50	90	FPS3017057	FPS3017058	
25,4	75,8	20	27,9	2	5	5°	8°	19,05	50	90	FPS3017059	FPS3017060	
26	77	20	28,5	2	5	5°	8°	25	55	96	FPS3017061	FPS3017062	
27	79	20	29,5	2	5	5°	8°	25	55	97	FPS3017063	FPS3017064	
28	81	20	30,5	2	5	5°	8°	25	55	98	FPS3017065	FPS3017066	
30	85	20	32,5	2	5	5°	8°	25	55	100	FPS3017067	FPS3017068	
32	89	20	34,5	2	5	5°	8°	25	55	102	FPS3017069	FPS3017070	
35	95	20	37,5	2	5	5°	8°	25	55	105	FPS3017071	FPS3017072	
40	105	20	42,5	2	5	5°	8°	25	55	110	FPS3017073	FPS3017074	
45	115	20	47,5	2	5	5°	8°	25	55	115	FPS3017075	FPS3017076	
50	125	20	52,5	2	5	5°	8°	25	55	120	FPS3017077	FPS3017078	
55	135	20	57,5	2	5	5°	8°	25	55	125	FPS3017079	FPS3017080	
60	145	20	62,5	2	5	5°	8°	25	55	130	FPS3017081	FPS3017082	

RADIUS 3 FPS3028

FRESA IN DIAMANTE MEZZO TONDO Z2

PCD HALF ROUND SHANK CUTTER Z2

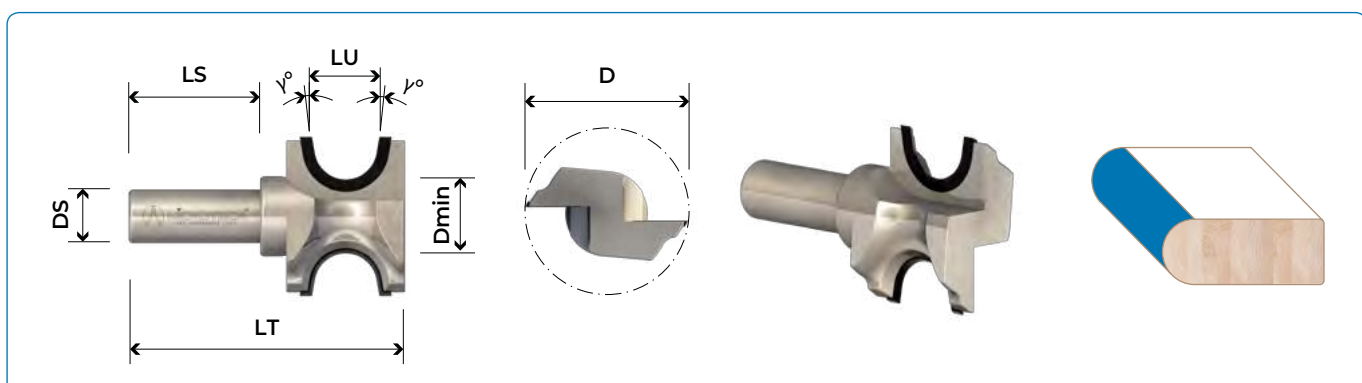
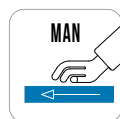
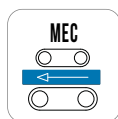

DIMENSIONI		DIMENSIONS					ARTICOLI		ITEMS		PREZZI €	
R	D	D min	LU	Z EFF	H PCD	gamma	DS	LS	LT	SX / LH	DX / RH	PRICE €
RADIUS	DIAMETER	DIAMETER	U. LENGTH	A. TEETH	PCD HEIGHT	γ°	SHANK DIAM.	S. LENGTH	TOT. LENGTH	CODICE / SKU	CODICE / SKU	
2	19	10	4	2	3	8°	12	40	56	FPS3028005	FPS3028006	
2,5	20	10	5	2	3	8°	12	40	57	FPS3028007	FPS3028008	
3	21	10	6	2	3	8°	12	40	58	FPS3028009	FPS3028010	
3,2	21,4	10	6,4	2	3	8°	12,7	40	58	FPS3028011	FPS3028012	
4	23	10	8	2	3	8°	12	40	60	FPS3028013	FPS3028014	
4,75	24,5	10	9,5	2	4	8°	12,7	40	62	FPS3028015	FPS3028016	
5	30	15	10	2	4	8°	12	40	62	FPS3028017	FPS3028018	
6	32	15	12	2	4	8°	12	40	64	FPS3028019	FPS3028020	
6,35	32,7	15	12,7	2	4	8°	12,7	50	75	FPS3028021	FPS3028022	
8	36	15	16	2	4	8°	12	40	68	FPS3028023	FPS3028024	
9,5	39	15	19	2	4	8°	12,7	40	71	FPS3028025	FPS3028026	
10	45	20	20	2	4	8°	20	50	82	FPS3028027	FPS3028028	
12	49	20	24	2	4	8°	20	50	86	FPS3028029	FPS3028030	
12,7	50,4	20	25,4	2	4	8°	19,05	50	87	FPS3028031	FPS3028032	
13	51	20	26	2	4	8°	20	50	88	FPS3028033	FPS3028034	
14	53	20	28	2	4	8°	20	50	90	FPS3028035	FPS3028036	
15	55	20	30	2	5	8°	20	50	92	FPS3028037	FPS3028038	
16	57	20	32	2	5	8°	20	50	94	FPS3028039	FPS3028040	
17	59	20	34	2	5	8°	20	50	96	FPS3028041	FPS3028042	
18	61	20	36	2	5	8°	20	50	98	FPS3028043	FPS3028044	
19	63	20	38	2	5	8°	20	50	100	FPS3028045	FPS3028046	
20	65	20	40	2	5	8°	20	50	102	FPS3028047	FPS3028048	
21	72	25	42	2	5	8°	20	50	104	FPS3028049	FPS3028050	
22	74	25	44	2	5	8°	20	50	106	FPS3028051	FPS3028052	
23	76	25	46	2	5	8°	20	50	108	FPS3028053	FPS3028054	
24	78	25	48	2	5	8°	20	50	110	FPS3028055	FPS3028056	
25	80	25	50	2	5	8°	20	50	112	FPS3028057	FPS3028058	
25,4	80,8	25	50,8	2	5	8°	19,05	50	113	FPS3028059	FPS3028060	
26	82	25	52	2	5	8°	25	55	119	FPS3028061	FPS3028062	
27	84	25	54	2	5	8°	25	55	121	FPS3028063	FPS3028064	
28	86	25	56	2	5	8°	25	55	123	FPS3028065	FPS3028066	
30	90	25	60	2	5	8°	25	55	127	FPS3028067	FPS3028068	

RADIUS 4 FPS3029

FRESA IN DIAMANTE MEZZO TONDO Z2+2

PCD HALF ROUND SHANK CUTTER Z2+2

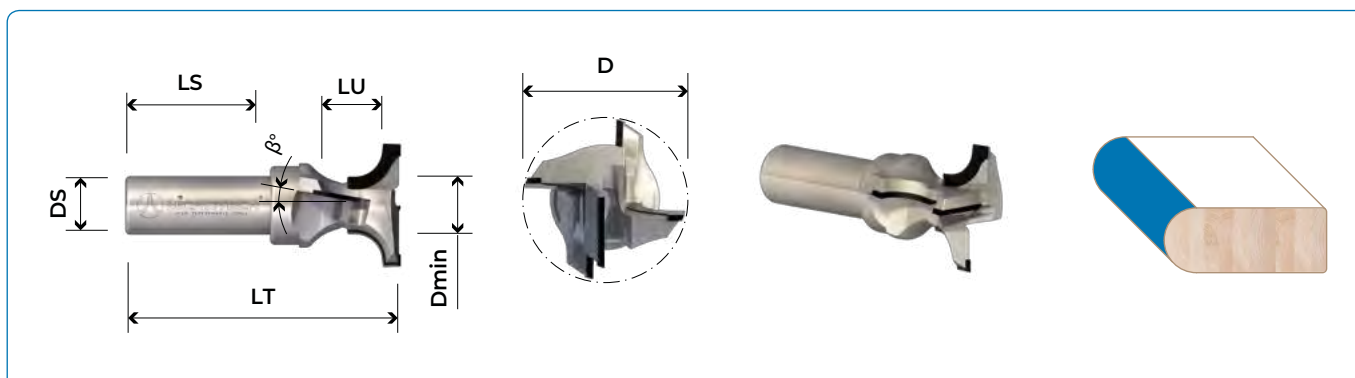
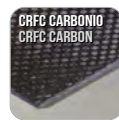
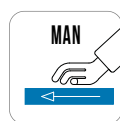
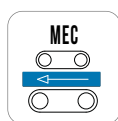

DIMENSIONI DIMENSIONS								ARTICOLI ITEMS				PREZZI €	
R	D	D min	LU	Z EFF	H PCD	β°	γ°	DS	LS	LT	SX / LH	DX / RH	PRICE €
RADIUS	DIAMETER	DIAMETER	U. LENGTH	A. TEETH	PCD HEIGHT			SHANK DIAM.	S. LENGTH	TOT. LENGTH	CODICE / SKU	CODICE / SKU	
8	36	15	16	2	4	10°	8°	12	40	76	FPS3029023	FPS3029024	
9	43	20	19	2	4	10°	8°	20	50	89	FPS3029061	FPS3029062	
9,5	44	20	19	2	4	10°	8°	12,7	40	79	FPS3029025	FPS3029026	
9,5	9,5	20	19	2	4	10°	8°	20	50	89	FPS3029063	FPS3029064	
10	45	20	20	2	4	10°	8°	20	50	90	FPS3029027	FPS3029028	
12	49	20	24	2	4	10°	8°	20	50	94	FPS3029029	FPS3029030	
12,7	50,4	20	25,4	2	4	10°	8°	19,05	50	95	FPS3029031	FPS3029032	
13	51	20	26	2	4	10°	8°	20	50	96	FPS3029033	FPS3029034	
14	53	20	28	2	4	10°	8°	20	50	98	FPS3029035	FPS3029036	
15	55	20	30	2	5	10°	8°	20	50	100	FPS3029037	FPS3029038	
16	57	20	32	2	5	10°	8°	20	50	102	FPS3029039	FPS3029040	
17	59	20	34	2	5	10°	8°	20	50	104	FPS3029041	FPS3029042	
18	66	25	36	2	5	10°	8°	20	50	106	FPS3029043	FPS3029044	
19	68	25	38	2	5	10°	8°	20	50	108	FPS3029045	FPS3029046	
20	75	30	40	2	5	10°	8°	20	50	110	FPS3029047	FPS3029048	
21	77	30	42	2	5	10°	8°	20	50	112	FPS3029049	FPS3029050	
22	79	30	44	2	5	10°	8°	20	50	114	FPS3029051	FPS3029052	
23	81	30	46	2	5	10°	8°	20	50	116	FPS3029053	FPS3029054	
24	83	30	48	2	5	10°	8°	20	50	118	FPS3029055	FPS3029056	
25	85	30	50	2	5	10°	8°	20	50	120	FPS3029057	FPS3029058	
25,4	85,8	30	50,8	2	5	10°	8°	19,05	50	121	FPS3029059	FPS3029060	

PROFILE 1 FPS3018

FRESA PER MANIGLIE PROFILO 1

PCD SHANK CUTTER FOR HANDLE. PROFILE N 1

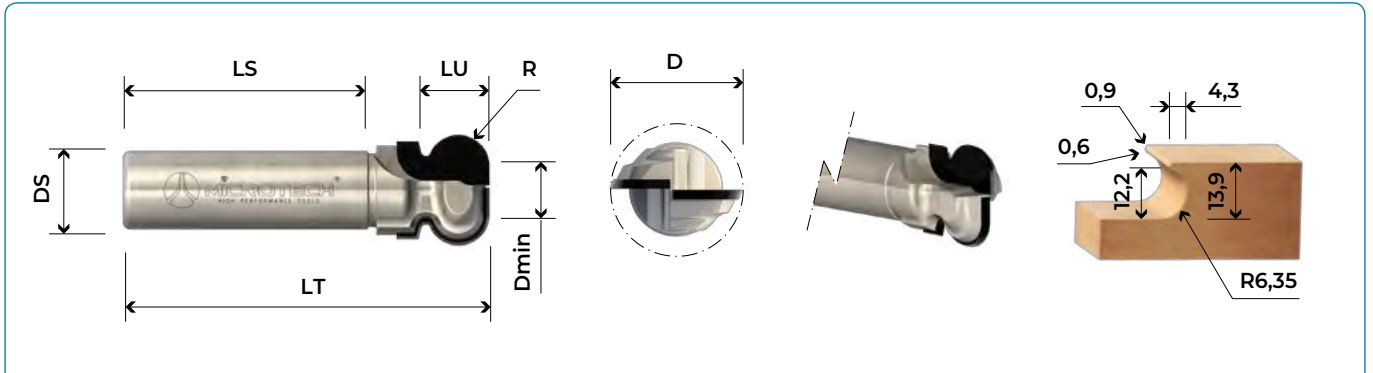

DIMENSIONI DIMENSIONS					ARTICOLI ITEMS		PREZZI €			
D	D min	LU	Z EFF	R	DS	LS	LT	SX / LH	DX / RH	PRICE €
DIAMETER	DIAMETER	U. LENGHT	A. TEETH	RADIUS	SHANK DIAM.	S. LENGHT	TOT. LENGHT	CODICE / SKU	CODICE / SKU	
22,6	14	14	2	6,35	12	40	70	FPS3018001	FPS3018002	
22,6	14	14	2	6,35	16	50	75	FPS3018003	FPS3018004	
22,6	14	14	2	6,35	20	50	75	FPS3018005	FPS3018006	

PROFILE 2 FPS3019

FRESA PER MANIGLIE PROFILO 2

PCD SHANK CUTTER FOR HANDLE. PROFILE N 2

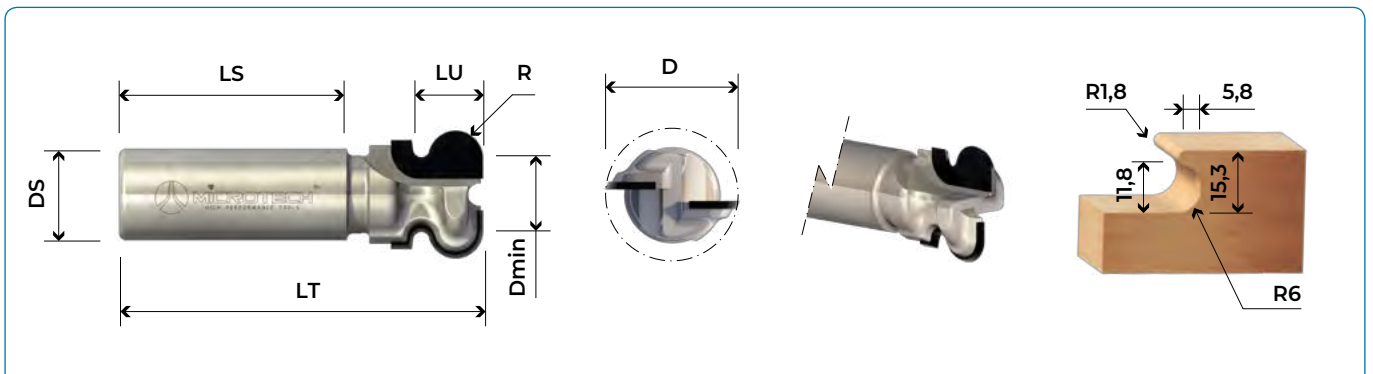

DIMENSIONI DIMENSIONS					ARTICOLI ITEMS		PREZZI €			
D	D min	LU	Z EFF	R	DS	LS	LT	SX / LH	DX / RH	PRICE €
DIAMETER	DIAMETER	U. LENGHT	A. TEETH	RADIUS	SHANK DIAM.	S. LENGHT	TOT. LENGHT	CODICE / SKU	CODICE / SKU	
28,5	16,5	15,3	2	6	12	40	70	FPS3019001	FPS3019002	
28,2	16,5	15,3	2	6	16	50	80	FPS3019003	FPS3019004	
28,2	16,5	15,3	2	6	20	50	80	FPS3019005	FPS3019006	

PROFILE 3 FPS3020

FRESA PER MANIGLIE PROFILO 3

PCD SHANK CUTTER FOR HANDLE. PROFILE N 3

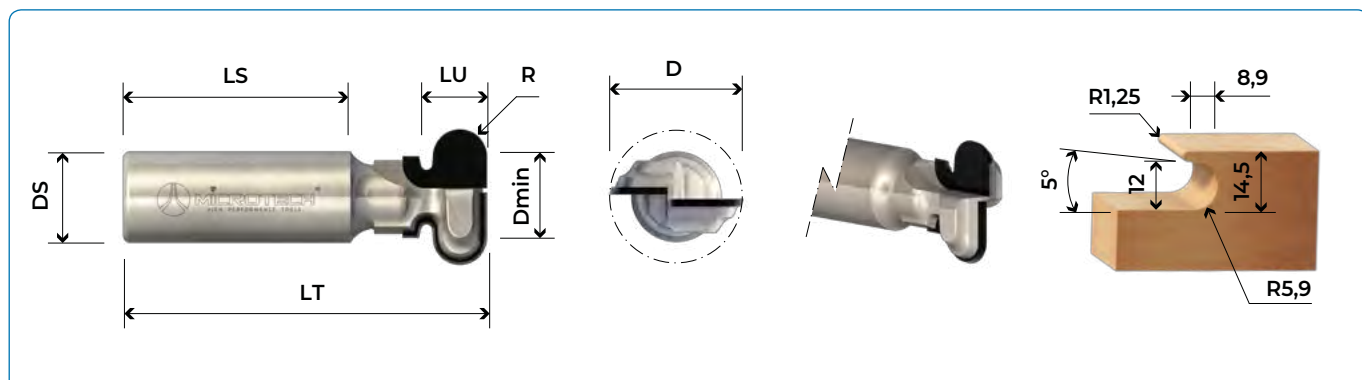
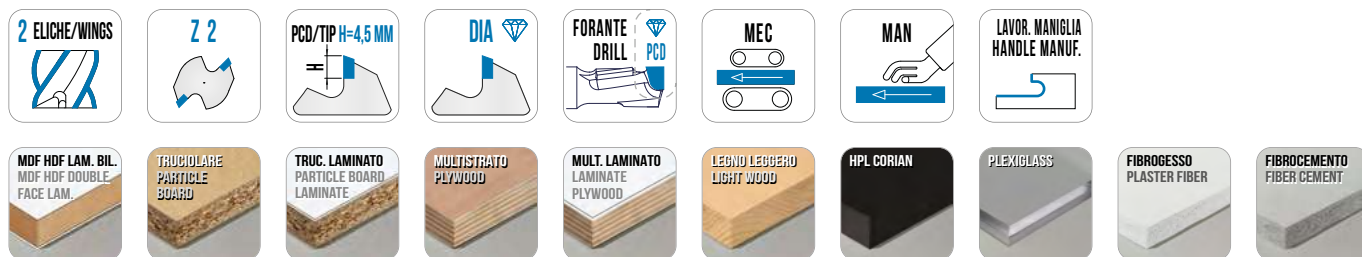

DIMENSIONI DIMENSIONS					ARTICOLI ITEMS			PREZZI €		
D	D min	LU	Z EFF	R	DS	LS	LT	SX / LH	DX / RH	PRICE €
DIAMETER	DIAMETER	U. LENGHT	A. TEETH	RADIUS	SHANK DIAM.	S. LENGHT	TOT. LENGHT	CODICE / SKU	CODICE / SKU	
29,8	12	14,5	2	5,9	12	40	70	FPS3020001	FPS3020002	
29,8	12	14,5	2	5,9	16	50	80	FPS3020003	FPS3020004	
29,8	12	14,5	2	5,9	20	50	80	FPS3020005	FPS3020006	

PROFILE 4 FPS3021

FRESA PER MANIGLIE PROFILO 4

PCD SHANK CUTTER FOR HANDLE. PROFILE N 4

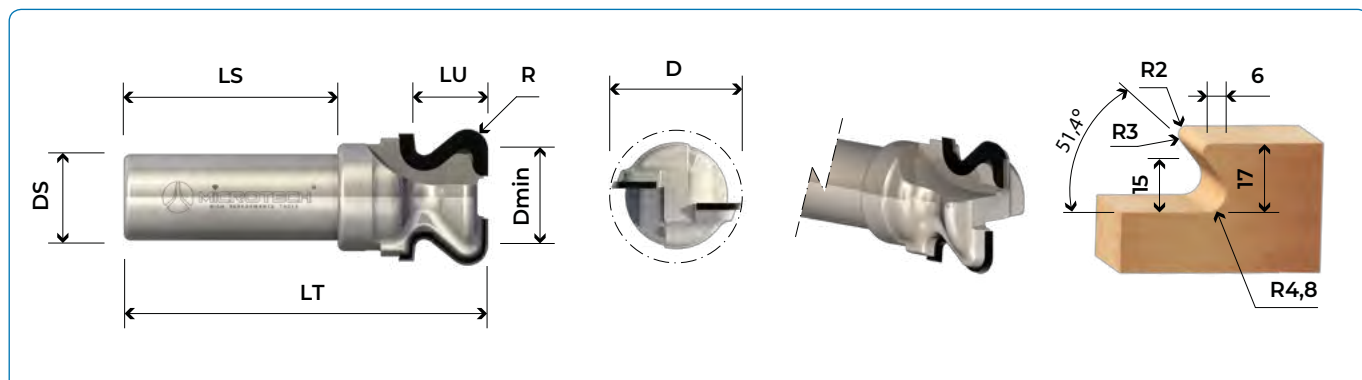

DIMENSIONI DIMENSIONS					ARTICOLI ITEMS			PREZZI €		
D	D min	LU	Z EFF	R	DS	LS	LT	SX / LH	DX / RH	PRICE €
DIAMETER	DIAMETER	U. LENGHT	A. TEETH	RADIUS	SHANK DIAM.	S. LENGHT	TOT. LENGHT	CODICE / SKU	CODICE / SKU	
32	20	17	2	4,8	12	40	75	FPS3021001	FPS3021002	
32	20	17	2	4,8	16	50	85	FPS3021003	FPS3021004	
32	20	17	2	4,8	20	50	85	FPS3021005	FPS3021006	

PROFILE 5 FPS3022

FRESA PER MANIGLIE PROFILO 5

PCD SHANK CUTTER FOR HANDLE. PROFILE N 5

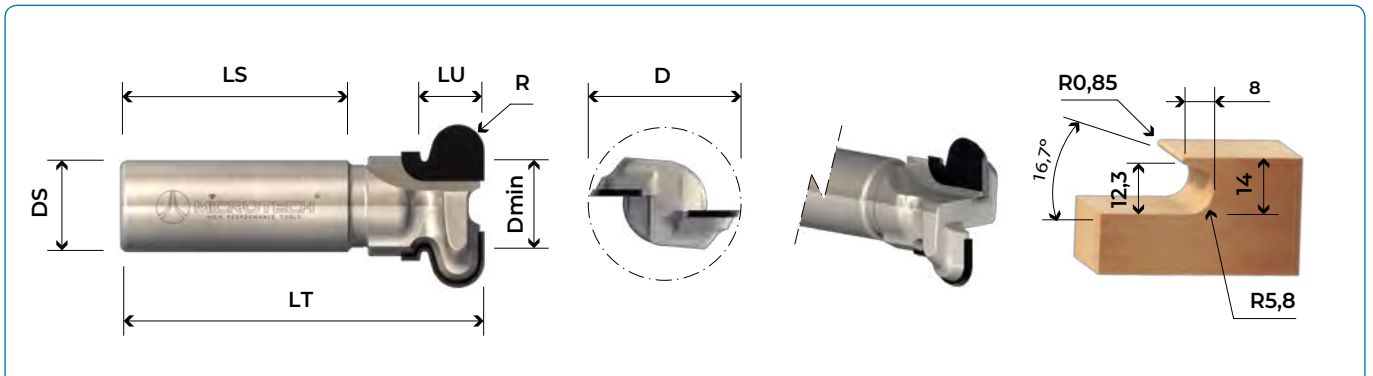
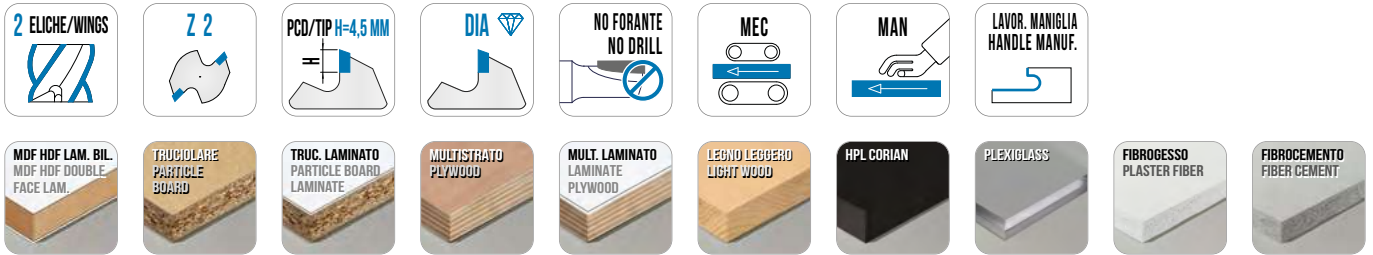

DIMENSIONI DIMENSIONS					ARTICOLI ITEMS			PREZZI €		
D	D min	LU	Z EFF	R	DS	LS	LT	SX / LH	DX / RH	PRICE €
DIAMETER	DIAMETER	U. LENGHT	A. TEETH	RADIUS	SHANK DIAM.	S. LENGHT	TOT. LENGHT	CODICE / SKU	CODICE / SKU	
36	20	14	2	5,8	12	40	70	FPS3022001	FPS3022002	
36	20	14	2	5,8	16	50	80	FPS3022003	FPS3022004	
36	20	14	2	5,8	20	50	80	FPS3022005	FPS3022006	

PROFILE 6 FPS3023

FRESA PER MANIGLIE PROFILO 6

PCD SHANK CUTTER FOR HANDLE. PROFILE N 6

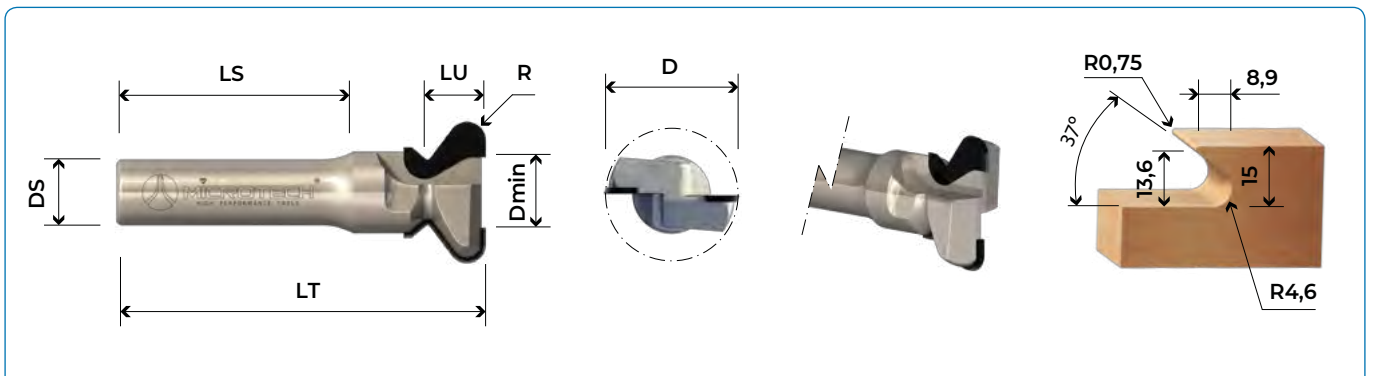

DIMENSIONI DIMENSIONS					ARTICOLI ITEMS			PREZZI €		
D	D min	LU	Z EFF	R	DS	LS	LT	SX / LH	DX / RH	PRICE €
DIAMETER	DIAMETER	U. LENGHT	A. TEETH	RADIUS	SHANK DIAM.	S. LENGHT	TOT. LENGHT	CODICE / SKU	CODICE / SKU	
34,4	16	15	2	4,6	12	40	80	FPS3023001	FPS3023002	
34,4	16	15	2	4,6	16	50	90	FPS3023003	FPS3023004	
34,4	16	15	2	4,6	20	50	90	FPS3023005	FPS3023006	

PROFILE 7 FPS3024

FRESA PER MANIGLIE PROFILO 7

PCD SHANK CUTTER FOR HANDLE. PROFILE N 7

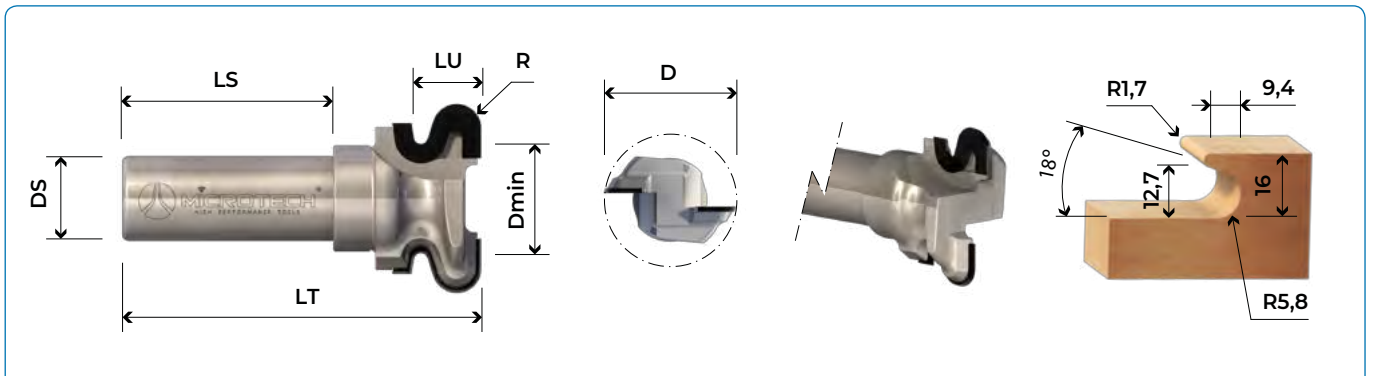
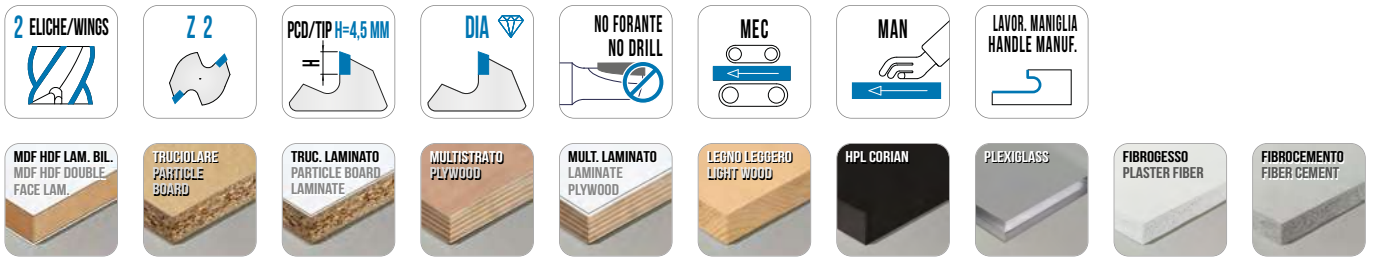

DIMENSIONI DIMENSIONS					ARTICOLI ITEMS			PREZZI €		
D	D min	LU	Z EFF	R	DS	LS	LT	SX / LH	DX / RH	PRICE €
DIAMETER	DIAMETER	U. LENGHT	A. TEETH	RADIUS	SHANK DIAM.	S. LENGHT	TOT. LENGHT	CODICE / SKU	CODICE / SKU	
45	26,2	16	2	5,8	12	40	75	FPS3024001	FPS3024002	
45	26,2	16	2	5,8	16	50	85	FPS3024003	FPS3024004	
45	26,2	16	2	5,8	20	50	85	FPS3024005	FPS3024006	

PROFILE 8 FPS3025

FRESA PER MANIGLIE PROFILO 8

PCD SHANK CUTTER FOR HANDLE. PROFILE N 8

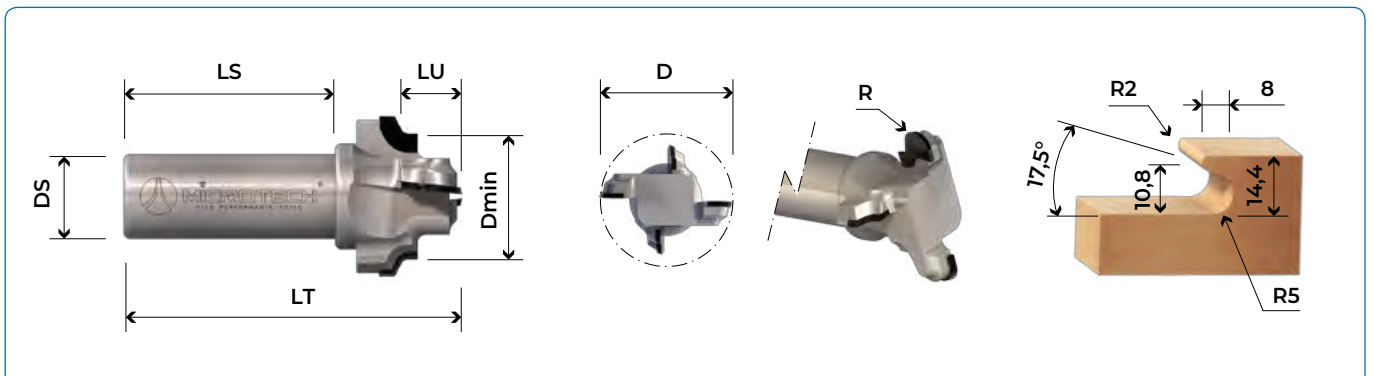

DIMENSIONI DIMENSIONS					ARTICOLI ITEMS			PREZZI €		
D	D min	LU	Z EFF	R	DS	LS	LT	SX / LH	DX / RH	PRICE €
DIAMETER	DIAMETER	U. LENGHT	A. TEETH	RADIUS	SHANK DIAM.	S. LENGHT	TOT. LENGHT	CODICE / SKU	CODICE / SKU	
46	30	14,4	4	5	12	40	70	FPS3025001	FPS3025002	
46	30	14,4	4	5	16	50	80	FPS3025003	FPS3025004	
46	30	14,4	4	5	20	50	80	FPS3025005	FPS3025006	

PROFILE 9 FPS3026

FRESA PER MANIGLIE PROFILO 9

PCD SHANK CUTTER FOR HANDLE. PROFILE N 9

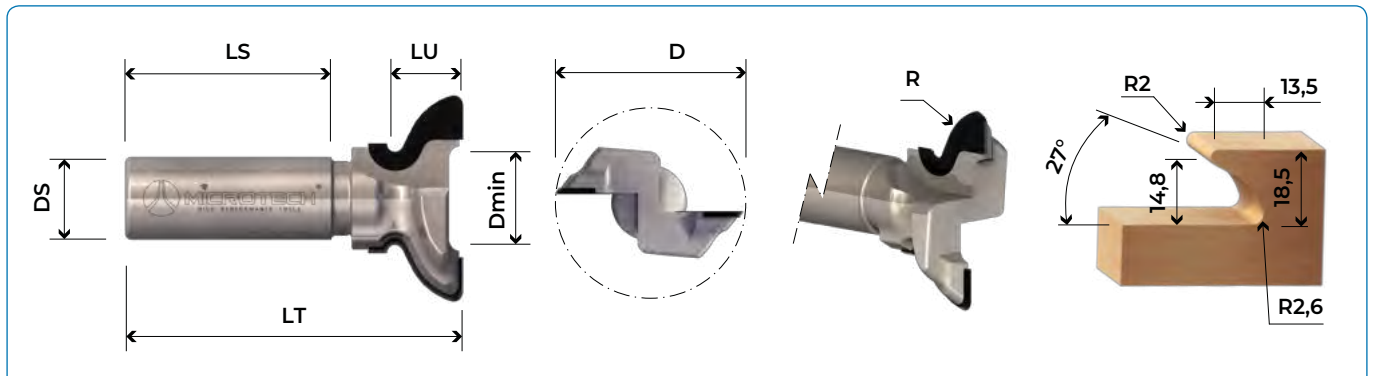

DIMENSIONI				DIMENSIONS				ARTICOLI		ITEMS		PREZZI €
D	D min	LU	Z EFF	R	DS	LS	LT	SX / LH	DX / RH	PRICE €		
DIAMETER	DIAMETER	U. LENGHT	A. TEETH	RADIUS	SHANK DIAM.	S. LENGHT	TOT. LENGHT	CODICE / SKU	CODICE / SKU			
50	23	18,6	2	16	12	40	70	FPS3026001	FPS3026002			
50	23	18,6	2	16	16	50	80	FPS3026003	FPS3026004			
50	23	18,6	2	16	20	50	80	FPS3026005	FPS3026006			

PROFILE 10 FPS3027

FRESA PER MANIGLIE PROFILO 10

PCD SHANK CUTTER FOR HANDLE. PROFILE N 10

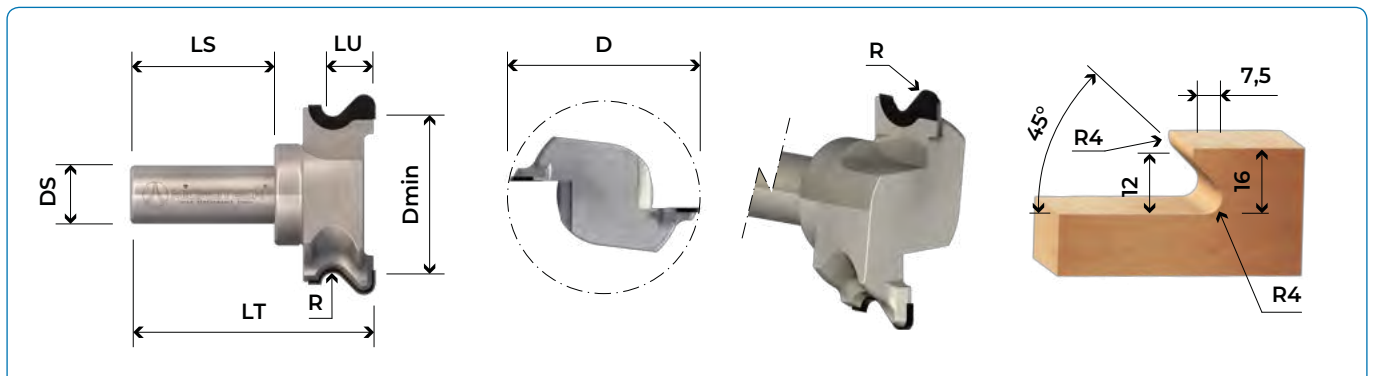

DIMENSIONI				DIMENSIONS				ARTICOLI		ITEMS		PREZZI €
D	D min	LU	Z EFF	R	DS	LS	LT	SX / LH	DX / RH	PRICE €		
DIAMETER	DIAMETER	U. LENGHT	A. TEETH	RADIUS	SHANK DIAM.	S. LENGHT	TOT. LENGHT	CODICE / SKU	CODICE / SKU			
70	55	16	2	4	12	40	75	FPS3027001	FPS3027002			
70	55	16	2	4	16	50	85	FPS3027003	FPS3027004			
70	55	16	2	4	20	50	85	FPS3027005	FPS3027006			

MFX 1 FPS3001

FRESA ALTA PRECISIONE PORTA INSERTI INTERCAMBIABILI IN DIAMANTE CON CUSCINETTO COPIA

HIGH PRECISION SHANK CUTTER MULTITASKING WITH INTERCHANGEABLE PROFILED PCD INSERT WITH COPY BEARING

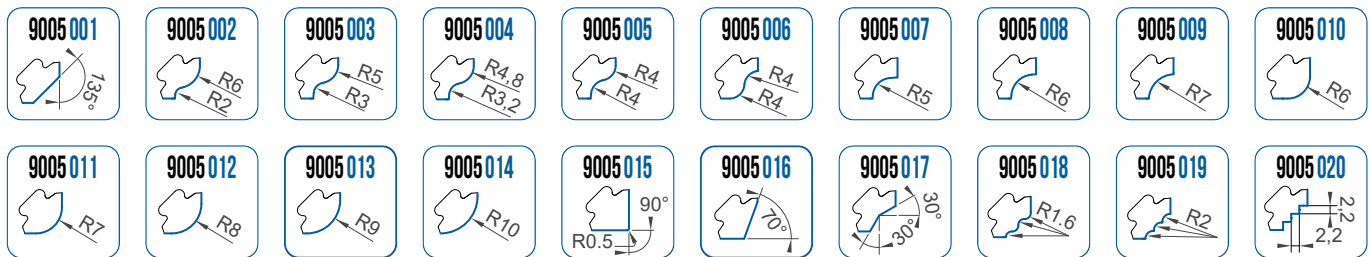
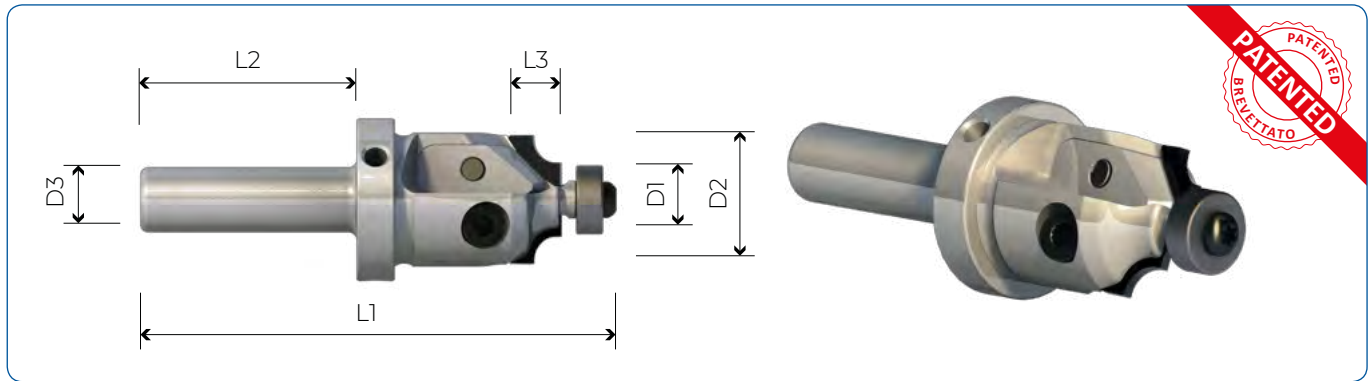

Fresa multitasking porta inserti in PCD a profilo sagomato intercambiabile con cuscinetto copia, adatta per eseguire profili su vari materiali; legno massello di qualsiasi essenza, pannelli truciolari, multistrati, laminati, MDF, HDF, HPL, trespas, corian, pannelli in fibra di carbonio (CFRP) nylon, teflon, plexiglas ed altre materie plastiche, alluminio.

I vantaggi di questo utensile sono le particolari geometrie costruttive che permettono di eliminare qualsiasi errore di accoppiamento tra corpo fresa ed inserto garantendo una alta precisione di posizionamento e ripetibilità, altro vantaggio molto importante è che l'inserto in diamante viene lavorato completamente a freddo e non subisce nessuno stress termico dovuto alla brasatura mantenendo tutte le caratteristiche native del PCD aumentando notevolmente la durata dell'utensile e la qualità del taglio.

Insert PCD shank cutter multitasking with interchangeable profiled knife and copy bearing. Suitable for profiling on different materials such as solid wood, laminated chipboard panels, plywood MDF, HDF, HPL, Trespa, Corian, Carbon fiber panels (CFRP), Teflon, plaxiglass, aluminium and others plastic materials.

So many are the advantages of this tool: Constructive geometries that eliminate any mismatch between the cutter body and the PCD insert ensuring high positioning of inserts and repeatability. Another advantage is that the PCD insert is worked in a cold conditions without undergoing any kind of stress due to welding operation. So the PCD inserts keep all the features, increasing the tool life and cutting quality.



DIMENSIONI DIMENSIONS							ARTICOLI ITEMS	PREZZI €
D1	D2	D3	L1	L2	L3	N° Z=	DX / RH	PRICE €
12,7	26	12	88	40	10	2	FPS3001002	
1/2 "	26	1/2 "	85	40	10	2	FPS3001004	
DIA PROFILE KNIFE							RIC9005001-020	
CLAMPING WEDGE							RIC9006001	
CLAMPING SCREW							RIC9006002	
BEARING							RIC9006003	
SCREW FOR BEARING							RIC9006004	

MFX 2 FPS3002

FRESA ALTA PRECISIONE PORTA INSERTI INTERCAMBIABILI IN DIAMANTE CON TAGLIENTE CENTRALE

HIGH PRECISION SHANK CUTTER MULTITASKING WITH INTERCHANGEABLE PROFILED PCD INSERTS WITH CENTER CUTTING KNIFE

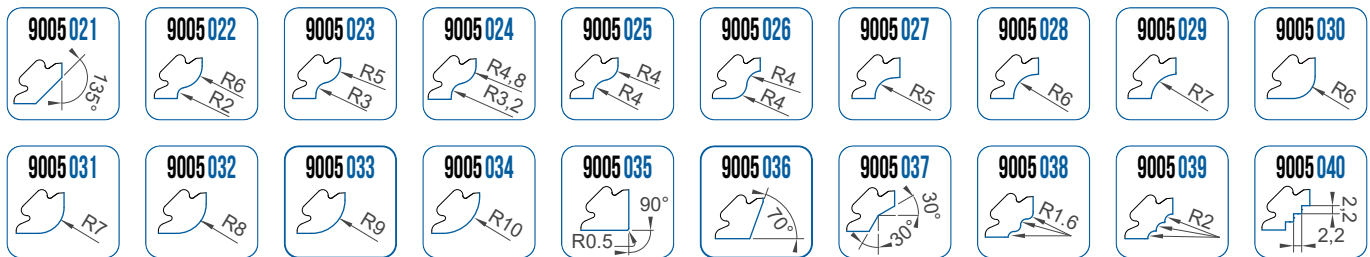
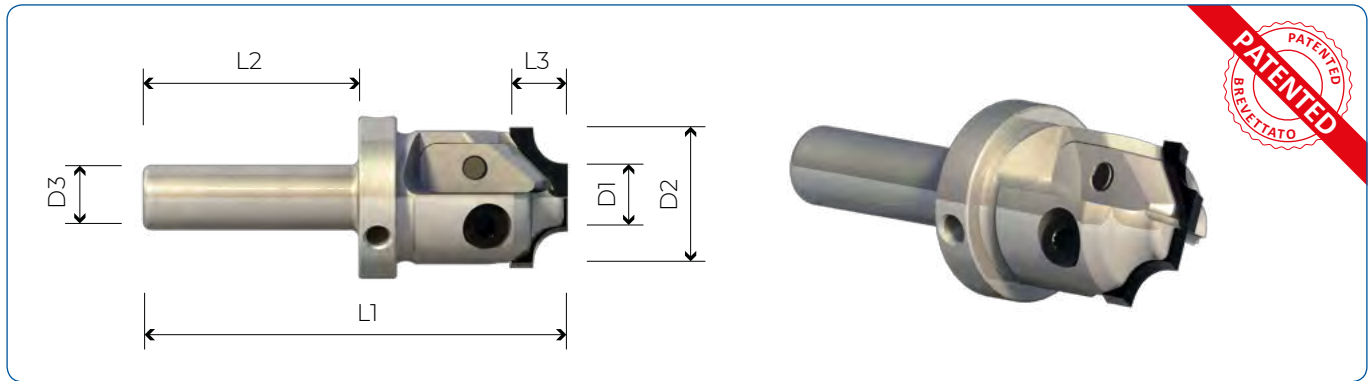

Fresa multitasking porta inserti in PCD a profilo sagomato intercambiabile con tagliente centrale, adatta per eseguire profili su vari materiali; legno massello di qualsiasi essenza, pannelli truciolari, multistrati, laminati, MDF, HDF, HPL, trespas, corian, pannelli in fibra di carbonio (CFRP) nylon, teflon, plexiglas ed altre materie plastiche, alluminio, ripresa lavorazioni di sagomatura nesting dopo la fase di taglio. I vantaggi di questo utensile sono le particolari geometrie costruttive che permettono di eliminare qualsiasi errore di accoppiamento tra corpo fresa ed inserto garantendo una alta precisione di posizionamento, ripetibilità in run out, altro vantaggio molto importante è che l'inserto in diamante viene lavorato completamente a freddo e non subisce nessuno stress termico dovuto alla brasatura mantenendo tutte le caratteristiche native del PCD aumentando notevolmente la durata dell'utensile e la qualità del taglio.

Insert PCD shank cutter multitasking with interchangeable profiled knife and center cutting knife. Suitable for profiling on different materials such as solid wood, laminated chipboard panels, plywood MDF, HDF, HPL, Trespa, Corian, Carbon fiber panels (CFRP), Teflon, plaxiglass, aluminium and others plastic materials. To be used also on finishing passage on nesting operation after sizing.

So many are the advantages of this tool: Constructive geometries that eliminate any mismatch between the cutter body and the PCD insert ensuring high positioning of inserts and repeatability. Another advantage is that the PCD insert is worked in a cold conditions without undergoing any kind of stress due to welding operation. So the PCD inserts keep all the features, increasing the tool life and cutting quality.



DIMENSIONI DIMENSIONS							ARTICOLI ITEMS	PREZZI €
D1	D2	D3	L1	L2	L3	N° Z=	DX / RH	PRICE €
1/2 "	26	12	85	50	10	2	FPS3002002	
1/2 "	26	20	85	50	10	2	FPS3002004	
1/2 "	26	1/2 "	85	50	10	2	FPS3002006	
1/2 "	26	3/4 "	85	50	10	2	FPS3002008	
DIA PROFILE KNIFE							RIC9005021-040	
CLAMPING WEDGE							RIC9006007	
CLAMPING SCREW							RIC9006002	

MFX 3 FPS3003

FRESA ALTA PRECISIONE PORTA INSERTI INTERCAMBIABILI IN DIAMANTE PER PROFILI A "V" DI 90° / 91°

HIGH PRECISION SHANK CUTTER WITH INTERCHANGEABLE PCD PROFILED INSERTS FOR "V" PROFILES AT 90° / 91°

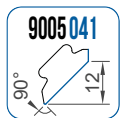
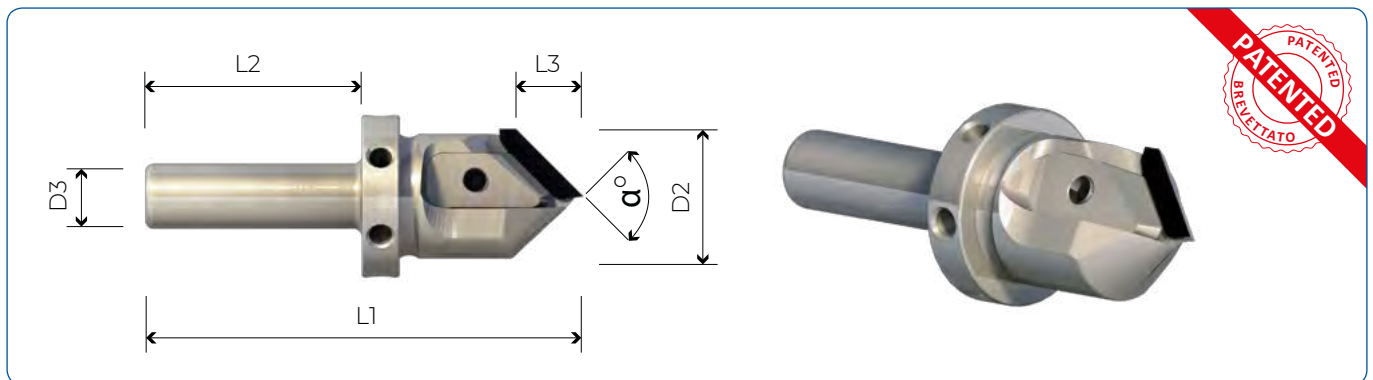

Fresa porta inserti in PCD profilo a "V" di 90° / 91° Z=1, adatta per eseguire profili o folding su vari materiali; legno massello di qualsiasi essenza, pannelli truciolari, multistrati, MDF, HDF, HPL, Trespa, corian, pannelli in fibra di carbonio (CFRP) nylon, teflon, plexiglas ed altre materie plastiche, alluminio.

I vantaggi di questo utensile sono le particolari geometrie costruttive che permettono di eliminare qualsiasi errore di accoppiamento tra corpo fresa ed inserto garantendo una alta precisione di posizionamento, ripetibilità in run out, altro vantaggio molto importante è che l'inserto in diamante viene lavorato completamente a freddo e non subisce nessuno stress termico dovuto alla brasatura mantenendo tutte le caratteristiche native del PCD aumentando notevolmente la durata dell'utensile e la qualità del taglio.

Insert PCD shank cutter with interchangeable profiled knife for cutting "V" profiles at 90° / 91° Z=1. Suitable for profiling or for folding operation on different materials such as solid wood, laminated chipboard panels, plywood MDF, HDF, HPL, Trespa, Corian, Carbon fiber panels (CFRP), Teflon, plaxiglass, aluminium and others plastic materials.

So many are the advantages of this tool: Constructive geometries that eliminate any mismatch between the cutter body and the PCD insert ensuring high positioning of inserts and repeatability. Another advantage is that the PCD insert is worked in a cold conditions without undergoing any kind of stress due to welding operation. So the PCD inserts keep all the features, increasing the tool life and cutting quality.

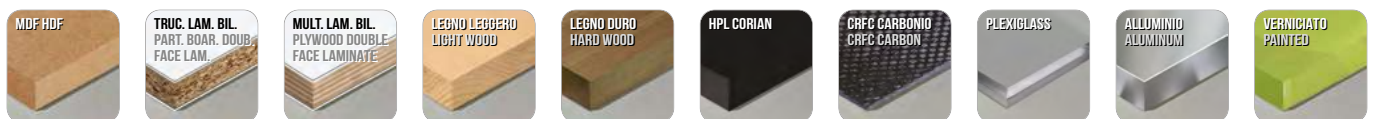

DIMENSIONI DIMENSIONS							ARTICOLI ITEMS	PREZZI €
D2	D3	α°	L1	L2	L3	N° Z=	DX / RH	PRICE €
25	12	90°	85	45	12	1	FPS3003002	
25	20	90°	90	50	12	1	FPS3003004	
25	1/2 "	90°	85	45	12	1	FPS3003006	
25	3/4 "	90°	90	50	12	1	FPS3003008	
							DIA PROFILE KNIFE	RIC9005041-042
							CLAMPING WEDGE	RIC9006008
							CLAMPING SCREW	RIC9006002

MFX 4 FPS3004

FRESA ALTA PRECISIONE PORTA INSERTI INTERCAMBIABILI IN DIAMANTE PER PROFILI A "V" DI 90° / 91°

HIGH PRECISION SHANK CUTTER WITH INTERCHANGEABLE PCD PROFILED INSERTS FOR "V" PROFILES AT 90° / 91°

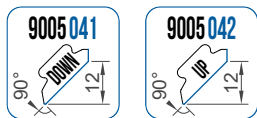
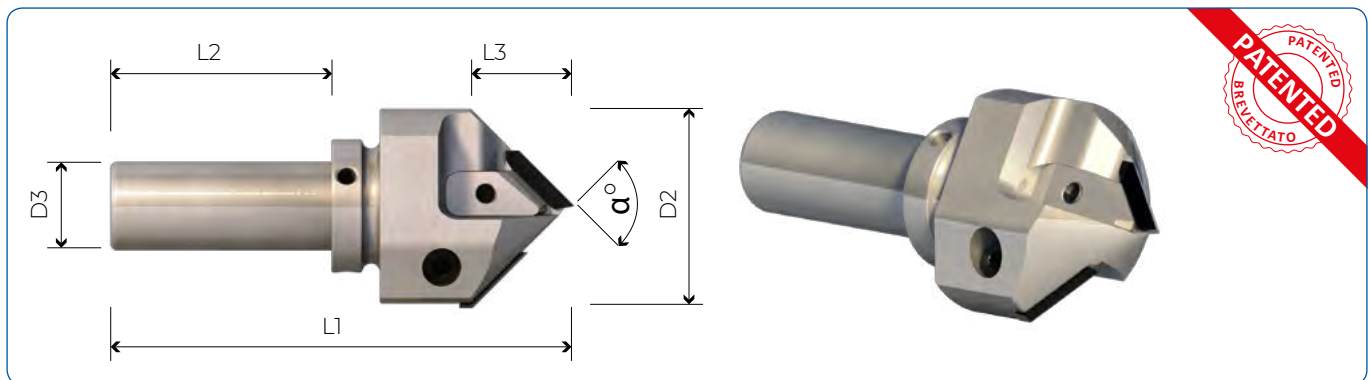

Fresa porta inserti in PCD profilo a "V" di 90° / 91° Z=1+1, adatta per eseguire profili o folding su vari materiali; legno massello di qualsiasi essenza, pannelli truciolari, multistrati, MDF, HDF, HPL, trespas, corian, pannelli in fibra di carbonio (CFRP) nylon, teflon, plexiglas ed altre materie plastiche, alluminio.

I vantaggi di questo utensile sono le particolari geometrie costruttive che permettono di eliminare qualsiasi errore di accoppiamento tra corpo fresa ed inserto garantendo una alta precisione di posizionamento, ripetibilità in run out, altro vantaggio molto importante è che l'inserto in diamante viene lavorato completamente a freddo e non subisce nessuno stress termico dovuto alla brasatura mantenendo tutte le caratteristiche native del PCD aumentando notevolmente la durata dell'utensile e la qualità del taglio.

Insert PCD shank cutter with interchangeable profiled knife for cutting "V" profiles at 90° / 91° Z=1+1. Suitable for profiling or for folding operation on different materials such as solid wood, laminated chipboard panels, plywood MDF, HDF, HPL, Trespa, Corian, Carbon fiber panels (CFRP), Teflon, plaxiglass, aluminium and others plastic materials.

So many are the advantages of this tool: Constructive geometries that eliminate any mismatch between the cutter body and the PCD insert ensuring high positioning of inserts and repeatability. Another advantage is that the PCD insert is worked in a cold conditions without undergoing any kind of stress due to welding operation. So the PCD inserts keep all the features, increasing the tool life and cutting quality.



DIMENSIONI DIMENSIONS							ARTICOLI ITEMS	PREZZI €
D2	D3	α°	L1	L2	L3	N° Z=	DX / RH	PRICE €
46	20	90°/91°	100	50	22	1+1	FPS3004002	
46	3/4"	90°/91°	100	50	22	1+1	FPS3004004	
							DIA PROFILE KNIFE	RIC9005041-042
							CLAMPING WEDGE	RIC9006009
							CLAMPING SCREW	RIC9006002

MFX 5 FPS3005

FRESA ALTA PRECISIONE PORTA INSERTI INTERCAMBIABILI IN DIAMANTE PER SPIANATURA E CALIBRATURA PIANI CNC
HIGH PRECISION SHANK CUTTER WITH INTERCHANGEABLE PCD INSERTS FOR PLANING SLAVE PANELS AND CNC MACHINE TABLES

RIGHT 	Z 4 	PCD/TIP H=3,5 MM 	POSITIVE 	ANGOLO ASSIALE AXIAL ANGLE 10° 	CORPO/BODY ACCIAIO STEEL 	MEC 	LOW NOISE 	R.P.M. MAX 16.000
------------------	----------------	-----------------------------	---------------------	---	-------------------------------------	----------------	----------------------	------------------------------

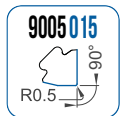
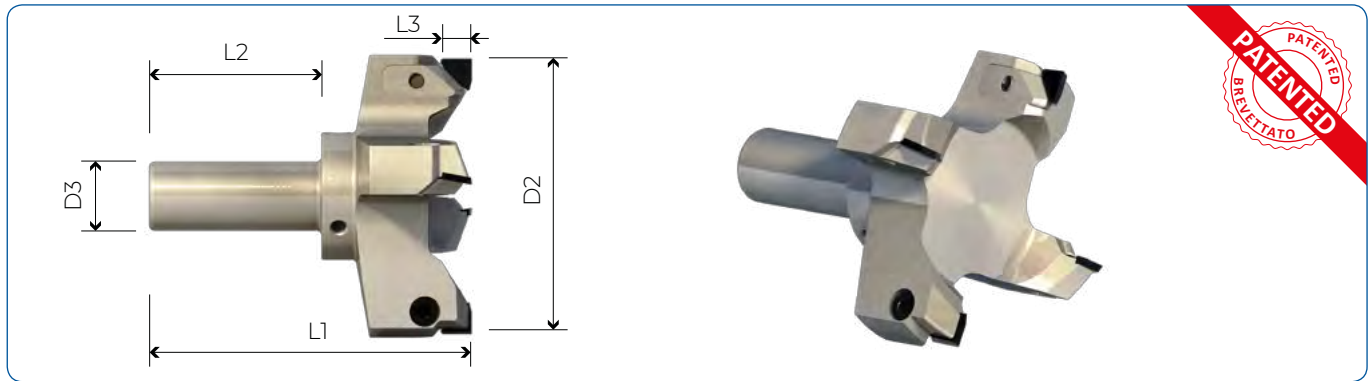

Fresa porta inserti intercambiabili in PCD adatta per eseguire lavori di spianatura e calibratura di piani macchine CNC su vari materiali; pannelli MDF, HDF, HPL, trespa, pannelli in fibra di carbonio (CFRP) etc. I vantaggi di questo utensile sono le particolari geometrie costruttive che permettono di eliminare qualsiasi errore di accoppiamento tra corpo fresa ed inserto garantendo una alta precisione di posizionamento, ripetibilità in run out, altro vantaggio molto importante è che l'inserto in diamante viene lavorato completamente a freddo e non subisce nessuno stress termico dovuto alla brasatura mantenendo tutte le caratteristiche native del PCD aumentando notevolmente la durata dell'utensile e la qualità del taglio.

Insert PCD shank cutter with interchangeable profiled knife for planing slave panels during nesting and for calibrating CNC machine tables. Suitable for working on different materials such as MDF, HDF, HPL, Trespa, Carbon fiber panels (CFRP). So many are the advantages of this tool: Constructive geometries that eliminate any mismatch between the cutter body and the PCD insert ensuring high positioning of inserts and repeatability. Another advantage is that the PCD insert is worked in a cold conditions without undergoing any kind of stress due to welding operation. So the PCD inserts keep all the features, increasing the tool life and cutting quality.



DIMENSIONI DIMENSIONS						ARTICOLI ITEMS	PREZZI €
D2	D3	L1	L2	L3	N° Z=	DX / RH	PRICE €
80	20	90	50	10	4	FPS3005002	
80	3/4"	90	50	10	4	FPS3005004	
						DIA PROFILE KNIFE	RIC9005060
						CLAMPING WEDGE	RIC9006010
						CLAMPING SCREW	RIC9006002

MFX 6 FPS3006

FRESA ALTA PRECISIONE PORTA INSERTI INTERCAMBIABILI IN DIAMANTE PER SPIANATURA E CALIBRATURA PIANI CNC

HIGH PRECISION SHANK CUTTER WITH INTERCHANGEABLE PCD INSERTS FOR PLANING SLAVE PANELS AND CNC MACHINE TABLES

RIGHT 	Z 4 	PCD/TIP H=3,5 MM 	POSITIVE 	ANGOLO ASSIALE AXIAL ANGLE 10° 	CORPO/BODY ACCIAIO STEEL 	MEC 	LOW NOISE 	R.P.M. MAX 16.000
------------------	----------------	-----------------------------	---------------------	---	-------------------------------------	----------------	----------------------	------------------------------

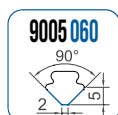
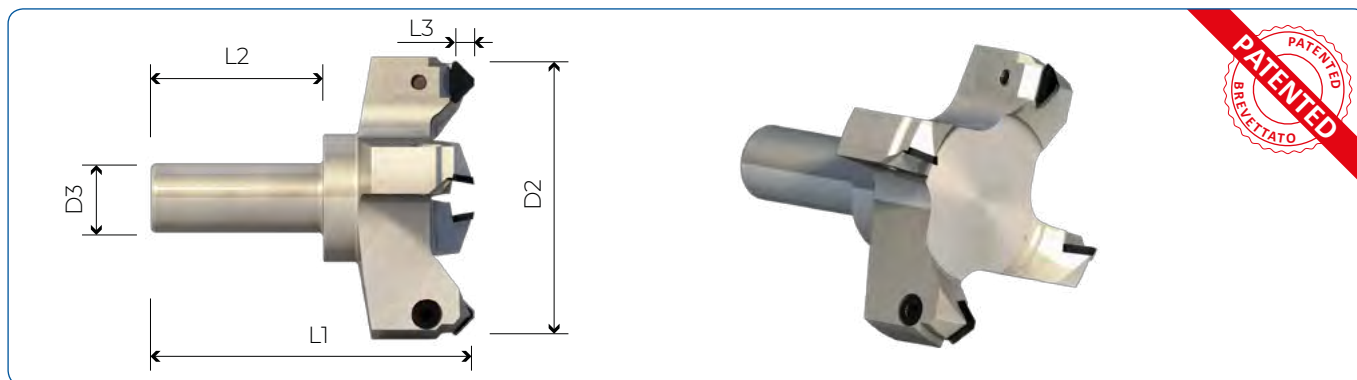

Fresa porta inserti intercambiabili in PCD adatta per eseguire lavori di spianatura e calibratura di piani macchine CNC su vari materiali; pannelli MDF, HDF, HPL, trespa, pannelli in fibra di carbonio (CFRP) etc.

E' possibile inoltre fare lavori di svuotamento pannelli con entrata in asse "Z" senza interpolazione.

I vantaggi di questo utensile sono le particolari geometrie costruttive che permettono di eliminare qualsiasi errore di accoppiamento tra corpo fresa ed inserto garantendo una alta precisione di posizionamento, ripetibilità in run out, altro vantaggio molto importante è che l'inserto in diamante viene lavorato completamente a freddo e non subisce nessuno stress termico dovuto alla brasatura mantenendo tutte le caratteristiche native del PCD aumentando notevolmente la durata dell'utensile e la qualità del taglio.

Insert PCD shank cutter with interchangeable profiled knife for planing slave panels during nesting and for calibrating CNC machine tables. Suitable for working on different materials such as MDF, HDF, HPL, Trespa, Carbon fiber panels (CFRP).

It is possible to work inside the panel using Z axes without interpolation.

So many are the advantages of this tool: Constructive geometries that eliminate any mismatch between the cutter body and the PCD insert ensuring high positioning of inserts and repeatability. Another advantage is that the PCD insert is worked in a cold conditions without undergoing any kind of stress due to welding operation. So the PCD inserts keep all the features, increasing the tool life and cutting quality.



DIMENSIONI DIMENSIONS						ARTICOLI ITEMS	PREZZI €
D2	D3	L1	L2	L3	N° Z=	DX / RH	PRICE €
80	20	90	50	10	4	FPS3006002	
80	3/4 "	90	50	10	4	FPS3006004	
						DIA PROFILE KNIFE	RIC9005015
						CLAMPING WEDGE	RIC9006011
						CLAMPING SCREW	RIC9006002

MFX 8 VARIO FPS3031

NEW

PORTAININSERTO FISSAGGIO MECCANICO ORIENTABILE

SHANK CUTTER WITH PCD SWIVELING INSERT

RIGHT

Z 1

PCD/TIP H=3.5MM

POSITIVE

CORPO/BODY
ACCIAIO
STEEL

MAN

MEC

LOW NOISE

R.P.M. MAX
24.000

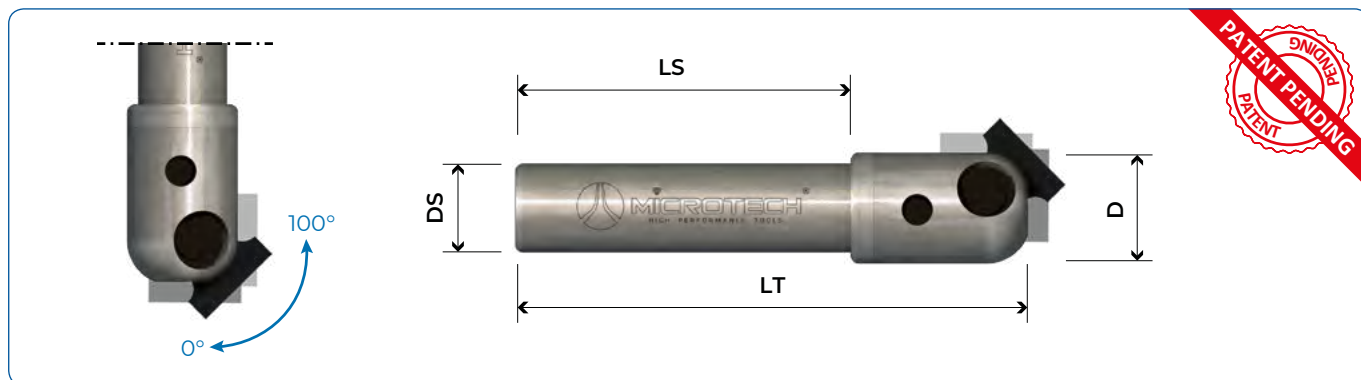

RIC9005 080 0°/100°	RIC9005 081 R10	RIC9005 082 R9	RIC9005 083 R8	RIC9005 084 R7	RIC9005 085 R6	RIC9005 086 R5	RIC9005 087 R4/1	RIC9005 088 R3/2	RIC9005 089 G1	RIC9005 090 G2
RIC9005 091 R10	RIC9005 092 R9	RIC9005 093 R8	RIC9005 094 R7	RIC9005 095 R6	RIC9005 096 R5	RIC9005 097 R4	RIC9005 098 R3	RIC9005 099 R2	RIC9005 100 60°	RIC9005 101 90°

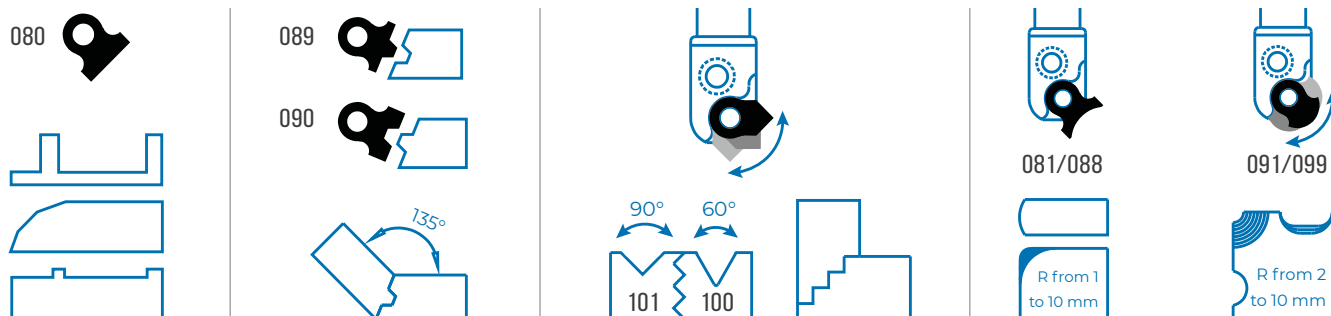

Corpo realizzato in acciaio inox, inserto in diamante integrale riaffilabile 2-3 volte. Precisione e ripetibilità di posizionamento. Semplicità di montaggio. Su richiesta profili personalizzati. Materiali lavorabili legno, truciolari, MDF, HPL, resine, plexiglass, fiberglass, pietra, leghe leggere, etc.

Body made of stainless steel. Integral pcd insert. Different adjustable profiles resharpening 2-3 times. Precision and repeatable position. Easy set up. On request custom profiles. Material to be processed wood, chipboard, MDF, HPL, fiberglass, light stones, resins, light alloy etc.



DIMENSIONI		DIMENSIONS			ARTICOLI		ITEMS	PREZZI €
D	DS	LT	LS	Z	CODICE		PRICE €	
DIAMETER	SHANK DIAMETER	TOTAL LENGTH	SHANK LENGTH	TOTAL TEETH	SKU			
15	12	70	40	1	FPS3031001	NEW		
INSERTO PROFILATO IN PCD / PCD PROFILE INSERT					RIC9005080-101	NEW		
BLOCCO DI FISSAGGIO / CLAMPING WEDGE					RIC9006013	NEW		
VITE / CLAMPING SCREW					RIC9006014	NEW		
VITE / CLAMPING SCREW					RIC9006015	NEW		

MFX 9 PLUS FPS3032

NEW

PORTAINSERTO FISSAGGIO MECCANICO

PCD INSERT SHANK CUTTER

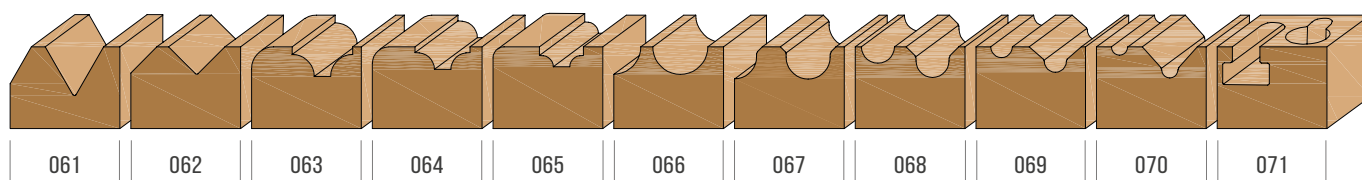
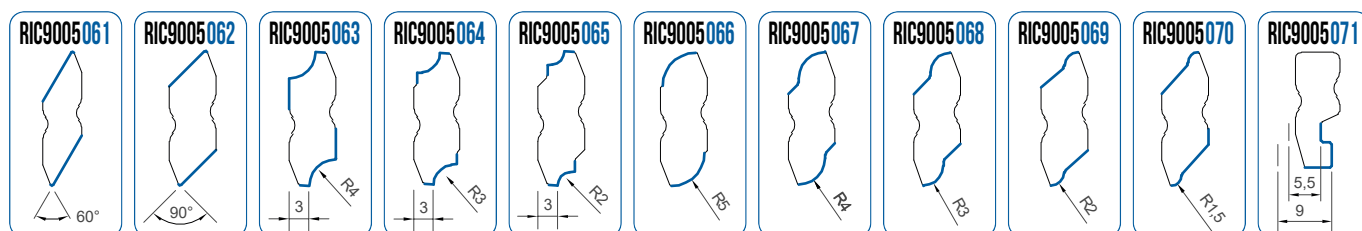
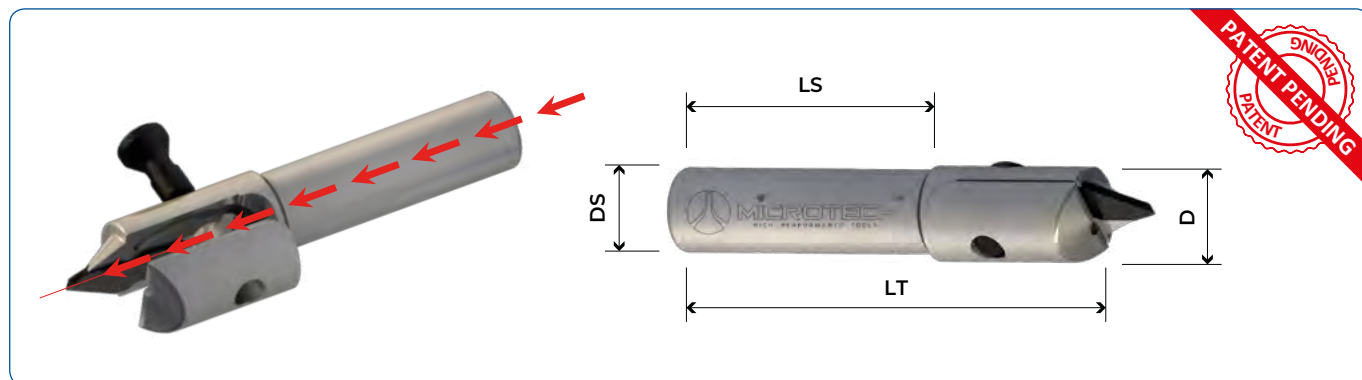

Corpo realizzato in acciaio inox. Passaggio interno fluido di raffreddamento o aria compressa. Inserto in diamante integrale riaffilabile 2-3 volte. Inserto reversibile con profilo a doppia figura. Precisione, ripetibilità di posizionamento e semplicità di montaggio. Su richiesta profili personalizzati. Materiali lavorabili legno, truciolari, MDF, HPL, resine, plexiglass, fiberglass, pietra, leghe leggere, etc

Body made of stainless steel. Inside passage for cooling fluid or compressed air. Pcd insert reversible with double profile resharpening 2-3 times. Precision, repeatable position set up and easy set up. On request custom profiles. Material to be processed wood, chipboard, mdf, hpl, fiberglass, light stones, resins, light alloy etc.



DIMENSIONI DIMENSIONS				ARTICOLI ITEMS		PREZZI €
D DIAMETER	DS SHANK DIAMETER	LT TOTAL LENGTH	LS SHANK LENGTH	Z TOTAL TEETH	CODICE SKU	PRICE €
14	12	70	40	1	FPS3032001	NEW
INSERTO PROFILATO IN PCD / PCD PROFILE INSERT					RIC9005061-071	NEW
BLOCCO DI FISSAGGIO / CLAMPING WEDGE					RIC9006016	NEW
VITE / CLAMPING SCREW					RIC9006017	NEW



PUNTE FORATRICI

DRILLING BITS



PFO PFO7001

PUNTA FORATRICE
PER FORI PASSANTI Z1
PCD THROUGH
HOLE DRILLING BIT Z1

177
PAG.



PFP INFINITY 2 PFO7003

PUNTA FORATRICE
PER FORI CIECHI Z2
PCD BLIND
HOLES DRILLING BIT Z2

178
PAG.



PFL INFINITY 1 PFO7002

PUNTA FORATRICE
PER FORI PASSANTI Z2
PCD THROUGH
HOLE DRILLING BIT Z2

177
PAG.



PLC INFINITY 3 PFO7004

FRESA DIAMANTE PER GIUNZIONI
LAMELLO CLAMEX P-SYSTEM Z1
PCD SHANK CUTTER Z1
FOR LAMELLO CLAMEX P-SYSTEM Z1

178
PAG.



PLCR INFINITY 5 PFO7005
 PUNTA FORATRICE PER FORI CIECHI Z2+2 CON ROMPIRUCIOLO
 PCD BLIND HOLES DRILLING BIT Z2+2 WITH CHIP BREAKER
179 PAG.



PFS PFO7006
 PUNTA FORATRICE PER FORI CIECHI CON SVASATORE Z2+2
 PCD BLIND HOLES DRILLING BIT Z2+2 WITH COUNTERSINK
180 PAG.



PLC INFINITY 4 PFO7007 **NEW**
 PUNTA FORATRICE PER FORI CIECHI Z2+2 CON CENTRINO SALDATO
 DRILLING BIT FOR BLIND HOLES Z2 + 2 WITH WELDED CENTRAL PIN
181 PAG.



FOUR LINE
PFO7501 - PFO7502 - PFO7503
PFO7504 - PFO7505 - PFO7506
 PUNTA FORATRICE COMPONIBILE IN HW PER FORI CIECHI CON RASANTI HW E CORPO IN ACCIAIO
 4 FLUTE DOWEL DRILLS
182 PAG.



TWO LINE
PFO7507 - PFO7508 - PFO7509
 PUNTA FORATRICE COMPONIBILE HW PER FORI CIECHI CON RASANTI HW E CORPO IN ACCIAIO
 2 FLUTE DOWEL DRILLS
184 PAG.



R-LINE PFO7510 - PFO7511
 PUNTA FORATRICE CON ATTACCO RAPIDO IN HW PER FORI CIECHI CON RASANTI HW E CORPO IN ACCIAIO
 DOWEL DRILLS
185 PAG.



POWER LINE PFO7512 - PFO7513
 PUNTA FORATRICE IN HW CON ATTACCO RAPIDO PER FORI CIECHI CON RASANTI RAGGIATI E CORPO HW
 SOLID CARBIDE DOWEL DRILLS
186 PAG.



EXTREME PFO7514
 PUNTA FORATRICE IN HWM MICROGRANA PER FORATRICE AD ATTACCO RAPIDO
 SOLID CARBIDE DOWER DRILL HWM
187 PAG.



PLCH
PFO7515 - PFO7516 - PFO7517
 PUNTA FORATRICE PER CERNIERE AD ATTACCO RAPIDO
 HINGE BORING BITS
187 PAG.



FLINE L
PFO7518 - PFO7519 - PFO7520
 PUNTA FORATRICE COMPONIBILE IN HW A LANCIA PER FORI PASSANTI CON CORPO IN ACCIAIO
 HW THROUGH HOLES DRILLING BIT
189 PAG.



TLINE L
PFO7521 - PFO7522 - PFO7523
 PUNTA FORATRICE COMPONIBILE IN HW A LANCIA PER FORI PASSANTI CON CORPO IN ACCIAIO
 HW THROUGH HOLES DRILLING BIT
190 PAG.



TLINE 2L PFO7524 - PFO7525
 PUNTA FORATRICE IN HW A LANCIA CON DOPPIO SMUSSO E CORPO IN ACCIAIO
 HW THROUGH HOLES DRILLING BIT WITH SPECIAL SHARPENING
191 PAG.



TLINE 2LH PFO7526 - PFO7527
 PUNTA FORATRICE IN HW A LANCIA CON DOPPIO SMUSSO E CORPO IN ACCIAIO
 HW THROUGH HOLES DRILLING BIT WITH SPECIAL SHARPENING
192 PAG.



SVP SVASATORE PIANE
PFO7532 - PFO7533
 PUNTA FORATRICE COMPONIBILE IN HW PIANA CON SVASATORE FISSO
 SOLID CARBIDE DOWEL DRILL WITH COUNTERSINK
193 PAG.



SLV PFO7534
 PUNTA FORATRICE COMPONIBILE IN HW A LANCIA PER FORI PASSANTI CON CORPO IN ACCIAIO
 SOLID CARBIDE THROUGH HOLES DOWEL DRILL WITH COUNTERSINK
194 PAG.



PFO7528
 PUNTA FORATRICE IN HW PER FORI PASSANTI
 SOLID CARBIDE DRILLING BIT FOR THROUGH HOLES
195 PAG.



PFO7529
 PUNTA FORATRICE IN HW PER FORI CIECHI
 SOLID CARBIDE DRILLING BIT FOR BLIND HOLES
195 PAG.



PFO7530
 SVASATORE COMPONIBILE PER PUNTE FORATRICI IN HW MOD FLINE
 COUNTER SINK FOR DOWEL DRILLS MOD FLINE
196 PAG.



PFO7531
 SVASATORE COMPONIBILE PER PUNTE FORATRICI IN HW MOD TLINE
 COUNTER SINK FOR DOWEL DRILLS MOD TLINE
196 PAG.

PFO PF07001

PUNTA FORATRICE PER FORI PASSANTI Z1 PCD THROUGH HOLE DRILLING BIT Z1

Punta foratrice in diamante ad alto rendimento Z1 per fori passanti, ottima per eseguire fori passanti su pannelli truciolari, rivestiti, laminati, nobilitati, MDF.

PCD through hole drilling bit with high performance Z1. Suitable for through hole on laminated chipboard panels MDF.

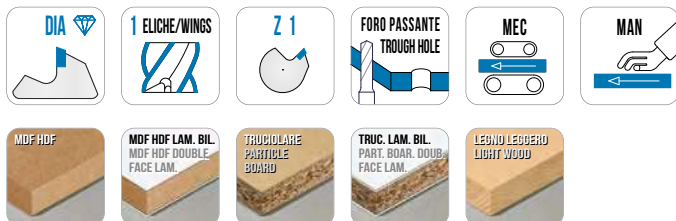
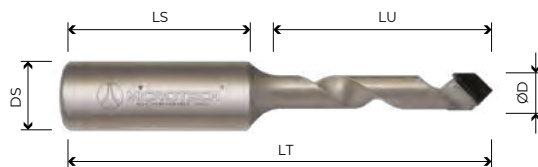

DIMENSIONI DIMENSIONS						ARTICOLI ITEMS			PREZZI €
D	LU	DS	LS	LT	Z EFF	CORPO	SX / LH	DX / RH	PRICE €
DIAMETER	USEFUL LENGHT	SHANK DIAMETER	SHANK LENGTH	TOT. LENGTH	ACTUAL TEETH	BODY	CODICE / SKU	CODICE / SKU	
5	28	10	25	57,5	1	Acciaio / Steel	PFO7001001	PFO7001002	
5	40	10	25	70	1	Acciaio / Steel	PFO7001003	PFO7001004	
6	28	10	25	57,5	1	Acciaio / Steel	PFO7001005	PFO7001006	
6	40	10	25	70	1	Acciaio / Steel	PFO7001007	PFO7001008	
8	28	10	25	57,5	1	Acciaio / Steel	PFO7001009	PFO7001010	
8	40	10	25	70	1	Acciaio / Steel	PFO7001011	PFO7001012	
10	28	10	25	57,5	1	Acciaio / Steel	PFO7001013	PFO7001014	
10	40	10	25	70	1	Acciaio / Steel	PFO7001015	PFO7001016	

PFL INFINITY 1 PF07002

PUNTA FORATRICE PER FORI PASSANTI Z2 PCD THROUGH HOLE DRILLING BIT Z2

Punta foratrice in diamante ad alto rendimento Z2 per fori passanti, ottima per eseguire fori passanti su pannelli truciolari, rivestiti, laminati, nobilitati, MDF.

PCD through hole drilling bit with high performance Z2. Suitable for through hole on laminated chipboard panels MDF.

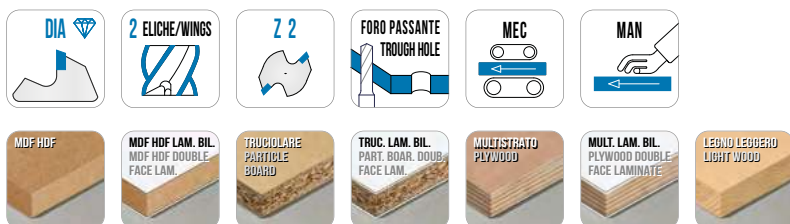
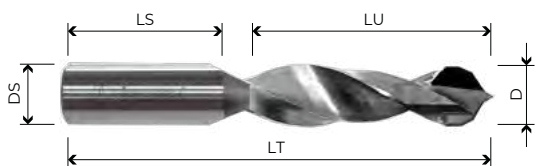

DIMENSIONI DIMENSIONS						ARTICOLI ITEMS			PREZZI €
D	LU	DS	LS	LT	Z EFF	CORPO	SX / LH	DX / RH	PRICE €
DIAMETER	USEFUL LENGHT	SHANK DIAMETER	SHANK LENGTH	TOT. LENGTH	ACTUAL TEETH	BODY	CODICE / SKU	CODICE / SKU	
5	28	10	27	57,5	2	HW	PFO7002001	PFO7002002	
5	40	10	27	70	2	HW	PFO7002003	PFO7002004	
6	28	10	27	57,5	2	HW	PFO7002005	PFO7002006	
6	40	10	27	70	2	HW	PFO7002007	PFO7002008	
7	28	10	20	57,5	2	HW	PFO7002009	PFO7002010	
7	40	10	20	70	2	HW	PFO7002011	PFO7002012	
8	28	10	20	57,5	2	HW	PFO7002013	PFO7002014	
8	40	10	20	70	2	HW	PFO7002015	PFO7002016	
10	28	10	20	57,5	2	HW	PFO7002017	PFO7002018	
10	40	10	20	70	2	HW	PFO7002019	PFO7002020	
12	28	10	20	57,5	2	Acciaio / Steel	PFO7002021	PFO7002022	
12	40	10	20	70	2	Acciaio / Steel	PFO7002023	PFO7002024	

PFP INFINITY 2 PF07003

PUNTA FORATRICE PER FORI CIECHI Z2 PCD BLIND HOLES DRILLING BIT Z2

Punta foratrice in diamante ad alto rendimento Z2 per fori ciechi, ottima per eseguire fori su pannelli truciolari, rivestiti, laminati, nobilitati, MDF.

PCD blind holes drilling bit with high performance Z2. Suitable for drilling on laminated chipboard panels MDF.

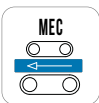
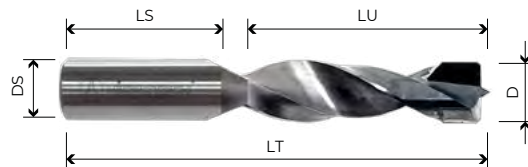

DIMENSIONI DIMENSIONS						ARTICOLI ITEMS			PREZZI €
D	LU	DS	LS	LT	Z EFF	CORPO	SX / LH	DX / RH	PRICE €
DIAMETER	USEFUL LENGHT	SHANK DIAMETER	SHANK LENGTH	TOT. LENGTH	ACTUAL TEETH	BODY	CODICE / SKU	CODICE / SKU	
5	28	10	27	57,5	2	HW	PFO7003001	PFO7003002	
5	40	10	27	70	2	HW	PFO7003003	PFO7003004	
6	28	10	27	57,5	2	HW	PFO7003005	PFO7003006	
6	40	10	27	70	2	HW	PFO7003007	PFO7003008	
7	28	10	20	57,5	2	HW	PFO7003009	PFO7003010	
7	40	10	20	70	2	HW	PFO7003011	PFO7003012	
8	28	10	20	57,5	2	HW	PFO7003013	PFO7003014	
8	40	10	20	70	2	HW	PFO7003015	PFO7003016	
10	28	10	20	57,5	2	HW	PFO7003017	PFO7003018	
10	40	10	20	70	2	HW	PFO7003019	PFO7003020	
12	28	10	20	57,5	2	Acciaio / Steel	PFO7003021	PFO7003022	
12	40	10	20	70	2	Acciaio / Steel	PFO7003023	PFO7003024	

PLC INFINITY 3 PF07004

PUNTA FORATRICE PER FORI CIECHI Z2+2 PCD BLIND HOLES DRILLING BIT Z2+2

Punta foratrice in diamante ad alto rendimento Z2+2 per fori ciechi con rasanti negativi.

PCD high performance blind holes drilling bit Z2+2 with negative shaver tips.

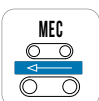
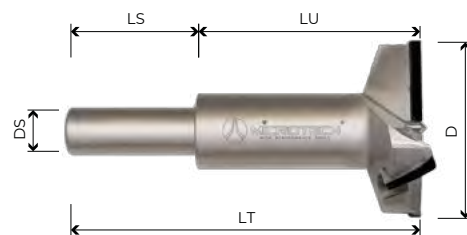

DIMENSIONI DIMENSIONS						ARTICOLI ITEMS			PREZZI €
D	LU	DS	LS	LT	Z EFF	CORPO	SX / LH	DX / RH	PRICE €
DIAMETER	USEFUL LENGHT	SHANK DIAMETER	SHANK LENGTH	TOT. LENGTH	ACTUAL TEETH	BODY	CODICE / SKU	CODICE / SKU	
12	28	10	25	57,5	2+2	Acciaio / Steel	PFO7004001	PFO7004002	
12	40	10	25	70	2+2	Acciaio / Steel	PFO7004003	PFO7004004	
14	28	10	25	57,5	2+2	Acciaio / Steel	PFO7004005	PFO7004006	
14	40	10	25	70	2+2	Acciaio / Steel	PFO7004007	PFO7004008	
15	28	10	25	57,5	2+2	Acciaio / Steel	PFO7004009	PFO7004010	
15	40	10	25	70	2+2	Acciaio / Steel	PFO7004011	PFO7004012	
16	28	10	25	57,5	2+2	Acciaio / Steel	PFO7004013	PFO7004014	
16	40	10	25	70	2+2	Acciaio / Steel	PFO7004015	PFO7004016	
18	28	10	25	57,5	2+2	Acciaio / Steel	PFO7004017	PFO7004018	
18	40	10	25	70	2+2	Acciaio / Steel	PFO7004019	PFO7004020	
20	28	10	25	57,5	2+2	Acciaio / Steel	PFO7004021	PFO7004022	
20	40	10	25	70	2+2	Acciaio / Steel	PFO7004023	PFO7004024	
22	28	10	25	57,5	2+2	Acciaio / Steel	PFO7004025	PFO7004026	
22	40	10	25	70	2+2	Acciaio / Steel	PFO7004027	PFO7004028	
25	28	10	25	57,5	2+2	Acciaio / Steel	PFO7004029	PFO7004030	
25	40	10	25	70	2+2	Acciaio / Steel	PFO7004031	PFO7004032	
26	28	10	25	57,5	2+2	Acciaio / Steel	PFO7004033	PFO7004034	
26	40	10	25	70	2+2	Acciaio / Steel	PFO7004035	PFO7004036	
30	28	10	25	57,5	2+2	Acciaio / Steel	PFO7004037	PFO7004038	
30	40	10	25	70	2+2	Acciaio / Steel	PFO7004039	PFO7004040	
35	28	10	25	57,5	2+2	Acciaio / Steel	PFO7004041	PFO7004042	
35	40	10	25	70	2+2	Acciaio / Steel	PFO7004043	PFO7004044	
35,5	28	10	25	57,5	2+2	Acciaio / Steel	PFO7004049	PFO7004050	
35,5	40	10	25	70	2+2	Acciaio / Steel	PFO7004051	PFO7004052	
40	28	10	25	57,5	2+2	Acciaio / Steel	PFO7004045	PFO7004046	
40	40	10	25	70	2+2	Acciaio / Steel	PFO7004047	PFO7004048	

PLCR INFINITY 5 PF07005

PUNTA FORATRICE PER FORI CIECHI Z2+2
CON ROMPITRUCIOLO

PCD BLIND HOLES DRILLING BIT Z2+2
WITH CHIP BREAKER

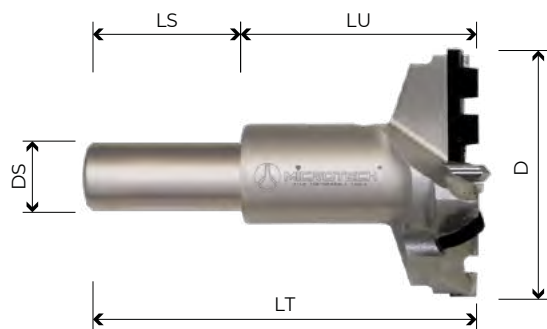

Punta foratrice in diamante ad alto rendimento Z2+2 per fori ciechi con rasanti negativi e placchette rompitruciolo. Ottima per eseguire fori passanti su pannelli truciolari, rivestiti, laminati, nobilitati, MDF.

PCD high performance blind holes drilling bit Z2+2 with negative shaver tips and chip breaker.

Suitable for drilling on laminated chipboard panels MDF.

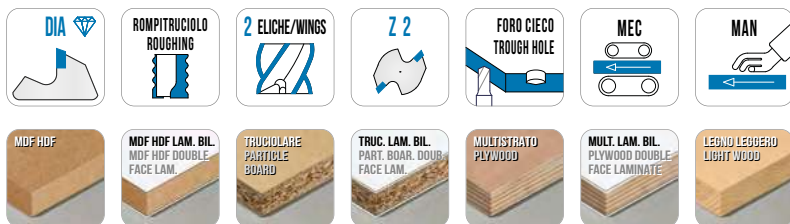

DIMENSIONI DIMENSIONS					ARTICOLI ITEMS		PREZZI €		
D	LU	DS	LS	LT	Z EFF	CORPO BODY	SX / LH CODICE / SKU	DX / RH CODICE / SKU	PRICE €
DIAMETER	USEFUL LENGHT	SHANK DIAMETER	SHANK LENGTH	TOT. LENGTH	ACTUAL TEETH				
20	28	10	25	57,5	2+2	Acciaio / Steel	PFO7005001	PFO7005002	
20	40	10	25	70	2+2	Acciaio / Steel	PFO7005003	PFO7005004	
22	28	10	25	57,5	2+2	Acciaio / Steel	PFO7005005	PFO7005006	
22	40	10	25	70	2+2	Acciaio / Steel	PFO7005007	PFO7005008	
25	28	10	25	57,5	2+2	Acciaio / Steel	PFO7005009	PFO7005010	
25	40	10	25	70	2+2	Acciaio / Steel	PFO7005011	PFO7005012	
26	28	10	25	57,5	2+2	Acciaio / Steel	PFO7005013	PFO7005014	
26	40	10	25	70	2+2	Acciaio / Steel	PFO7005015	PFO7005016	
30	28	10	25	57,5	2+2	Acciaio / Steel	PFO7005017	PFO7005018	
30	40	10	25	70	2+2	Acciaio / Steel	PFO7005019	PFO7005020	
35	28	10	25	57,5	2+2	Acciaio / Steel	PFO7005021	PFO7005022	
35	40	10	25	70	2+2	Acciaio / Steel	PFO7005023	PFO7005024	
35,5	28	10	25	57,5	2+2	Acciaio / Steel	PFO7005029	PFO7005030	
35,5	40	10	25	70	2+2	Acciaio / Steel	PFO7005031	PFO7005032	
40	28	10	25	57,5	2+2	Acciaio / Steel	PFO7005025	PFO7005026	
40	40	10	25	70	2+2	Acciaio / Steel	PFO7005027	PFO7005028	

PFS PFO7006

PUNTA FORATRICE PER FORI CIECHI CON SVASATORE Z2+2 PCD BLIND HOLES DRILLING BIT Z2+2 WITH COUNTERSINK

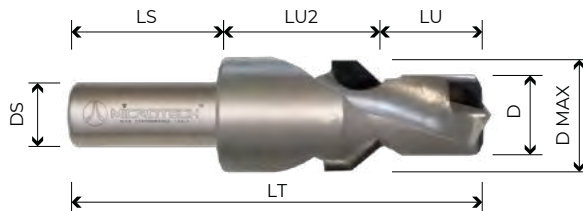

Punta foratrice in diamante ad alto rendimento Z2+2 per fori ciechi con svasatori negativi e **centrino in HW autocentrante**. Ottima per eseguire fori ciechi e svasati su pannelli truciolari, rivestiti, laminati, nobilitati, MDF.

PCD high performance blind holes drilling bit Z2+2 with negative countersink tips and **HW center tip**.

Suitable for drilling on laminated chipboard panels MDF

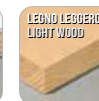
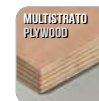
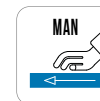
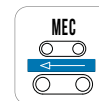
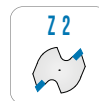

DIMENSIONI DIMENSIONS									ARTICOLI ITEMS			PREZZI €
D	LU	LU2	D MAX	DS	LS	LT	Z EFF	CORPO	SX / LH	DX / RH		PRICE €
DIAM.	U. LENGTH	U. LENGTH	DIAMETER	S. DIAMETER	SHANK LENGTH	T. LENGTH	ACTUAL TEETH	BODY	CODICE / SKU	CODICE / SKU		PRICE €
8	8	24,5	14	10	25	57,5	2+2	Acciaio / Steel	PFO7006001	PFO7006002		
8	8	37	14	10	25	70	2+2	Acciaio / Steel	PFO7006003	PFO7006004		
8	10	22,5	14	10	25	57,5	2+2	Acciaio / Steel	PFO7006005	PFO7006006		
8	10	35	14	10	25	70	2+2	Acciaio / Steel	PFO7006007	PFO7006008		
8	12	20,5	14	10	25	57,5	2+2	Acciaio / Steel	PFO7006009	PFO7006010		
8	12	33	14	10	25	70	2+2	Acciaio / Steel	PFO7006011	PFO7006012		
8	13	19,5	14	10	25	57,5	2+2	Acciaio / Steel	PFO7006013	PFO7006014		
8	13	32	14	10	25	70	2+2	Acciaio / Steel	PFO7006015	PFO7006016		
8	14	18,5	14	10	25	57,5	2+2	Acciaio / Steel	PFO7006017	PFO7006018		
8	14	31	14	10	25	70	2+2	Acciaio / Steel	PFO7006019	PFO7006020		
8	15	17,5	14	10	25	57,5	2+2	Acciaio / Steel	PFO7006021	PFO7006022		
8	15	30	14	10	25	70	2+2	Acciaio / Steel	PFO7006023	PFO7006024		
8	18	14,5	14	10	25	57,5	2+2	Acciaio / Steel	PFO7006025	PFO7006026		
8	18	27	14	10	25	70	2+2	Acciaio / Steel	PFO7006027	PFO7006028		
8	20	12,5	14	10	25	57,5	2+2	Acciaio / Steel	PFO7006029	PFO7006030		
8	20	25	14	10	25	70	2+2	Acciaio / Steel	PFO7006031	PFO7006032		
8	21	24	14	10	25	70	2+2	Acciaio / Steel	PFO7006033	PFO7006034		
8	22	23	14	10	25	70	2+2	Acciaio / Steel	PFO7006035	PFO7006036		
8	25	20	14	10	25	70	2+2	Acciaio / Steel	PFO7006037	PFO7006038		
8	30	15	14	10	25	70	2+2	Acciaio / Steel	PFO7006039	PFO7006040		
10	10	22,5	16	10	25	57,5	2+2	Acciaio / Steel	PFO7006041	PFO7006042		
10	10	35	16	10	25	70	2+2	Acciaio / Steel	PFO7006043	PFO7006044		
10	11	21,5	16	10	25	57,5	2+2	Acciaio / Steel	PFO7006045	PFO7006046		
10	11	34	16	10	25	70	2+2	Acciaio / Steel	PFO7006047	PFO7006048		
10	12	20,5	16	10	25	57,5	2+2	Acciaio / Steel	PFO7006049	PFO7006050		
10	12	33	16	10	25	70	2+2	Acciaio / Steel	PFO7006051	PFO7006052		
10	13	19,5	16	10	25	57,5	2+2	Acciaio / Steel	PFO7006053	PFO7006054		
10	13	32	16	10	25	70	2+2	Acciaio / Steel	PFO7006055	PFO7006056		
10	15	17,5	16	10	25	57,5	2+2	Acciaio / Steel	PFO7006057	PFO7006058		
10	15	30	16	10	25	70	2+2	Acciaio / Steel	PFO7006059	PFO7006060		
10	18	14,5	16	10	25	57,5	2+2	Acciaio / Steel	PFO7006061	PFO7006062		
10	18	27	16	10	25	70	2+2	Acciaio / Steel	PFO7006063	PFO7006064		
10	20	12,5	16	10	25	57,5	2+2	Acciaio / Steel	PFO7006065	PFO7006066		
10	20	25	16	10	25	70	2+2	Acciaio / Steel	PFO7006067	PFO7006068		
10	25	20	16	10	25	70	2+2	Acciaio / Steel	PFO7006069	PFO7006070		
10	30	15	16	10	25	70	2+2	Acciaio / Steel	PFO7006071	PFO7006072		
12	10	22,5	18	10	25	57,5	2+2	Acciaio / Steel	PFO7006073	PFO7006074		
12	10	35	18	10	25	70	2+2	Acciaio / Steel	PFO7006075	PFO7006076		
12	13	19,5	18	10	25	57,5	2+2	Acciaio / Steel	PFO7006077	PFO7006078		
12	13	32	18	10	25	70	2+2	Acciaio / Steel	PFO7006079	PFO7006080		
12	15	17,5	18	10	25	57,5	2+2	Acciaio / Steel	PFO7006081	PFO7006082		
12	15	30	18	10	25	70	2+2	Acciaio / Steel	PFO7006083	PFO7006084		
12	18	14,5	18	10	25	57,5	2+2	Acciaio / Steel	PFO7006085	PFO7006086		
12	18	27	18	10	25	70	2+2	Acciaio / Steel	PFO7006087	PFO7006088		
12	20	12,5	18	10	25	57,5	2+2	Acciaio / Steel	PFO7006089	PFO7006090		
12	20	25	18	10	25	70	2+2	Acciaio / Steel	PFO7006091	PFO7006092		
12	25	20	18	10	25	70	2+2	Acciaio / Steel	PFO7006093	PFO7006094		
12	30	15	18	10	25	70	2+2	Acciaio / Steel	PFO7006095	PFO7006096		

PLC INFINITY 4 PFO7007

NEW

PUNTA FORATRICE PER FORI CIECHI Z2+2 CON CENTRINO SALDATO

Punta foratrice in diamante ad alto rendimento Z2+2 per fori ciechi con rasanti negativi e centrino in HW saldato. Ottima per eseguire fori su pannelli truciolari, rivestiti, laminati, nobilitati e MDF.

DRILLING BIT FOR BLIND HOLES Z2 + 2 WITH WELDED CENTRAL PIN

Z2 + 2 high-performance diamond drill bit for blind holes with negative precutting and welded HW center pin. Excellent for making holes in chipboard, coated, laminated, melamine and MDF panels.

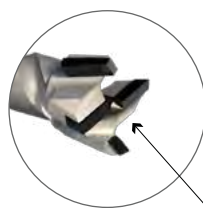
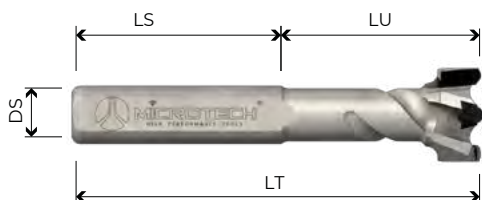

IL CENTRINO SALDATO AGEVOLA LO SCARICO DEL TRUCIOLO E EVITA ANNIDAMENTI A VOLTE PRESENTI NELLE FORATRICI CON CENTRINO MOBILE REGOLABILE E REMOVIBILE. THE WELDED CENTRAL FACILITATES THE EVACUATION OF WOODEN CHIP AND AVOID NESTINGS WHICH ARE SOMETIMES PRESENT IN THE BORING MACHINES WITH ADJUSTABLE AND REMOVABLE MOBILE CENTER PIN.



DIMENSIONI DIMENSIONS						ARTICOLI ITEMS			PREZZI €
D	LU	DS	LS	LT	Z EFF	CORPO	SX / LH	DX / RH	PRICE €
DIAMETER	USEFUL LENGHT	SHANK DIAMETER	SHANK LENGTH	TOT. LENGTH	ACTUAL TEETH	BODY	CODICE / SKU	CODICE / SKU	
12	28	10	25	57,5	2+2	Acciaio	PFO7007001	PFO7007002	
12	40	10	25	70	2+2	Acciaio	PFO7007003	PFO7007004	
14	28	10	25	57,5	2+2	Acciaio	PFO7007005	PFO7007006	
14	40	10	25	70	2+2	Acciaio	PFO7007007	PFO7007008	
15	28	10	25	57,5	2+2	Acciaio	PFO7007009	PFO7007010	
15	40	10	25	70	2+2	Acciaio	PFO7007011	PFO7007012	
16	28	10	25	57,5	2+2	Acciaio	PFO7007013	PFO7007014	
16	40	10	25	70	2+2	Acciaio	PFO7007015	PFO7007016	
18	28	10	25	57,5	2+2	Acciaio	PFO7007017	PFO7007018	
18	40	10	25	70	2+2	Acciaio	PFO7007019	PFO7007020	
20	28	10	25	57,5	2+2	Acciaio	PFO7007021	PFO7007022	
20	40	10	25	70	2+2	Acciaio	PFO7007023	PFO7007024	
22	28	10	25	57,5	2+2	Acciaio	PFO7007025	PFO7007026	
22	40	10	25	70	2+2	Acciaio	PFO7007027	PFO7007028	
25	28	10	25	57,5	2+2	Acciaio	PFO7007029	PFO7007030	
25	40	10	25	70	2+2	Acciaio	PFO7007031	PFO7007032	
26	28	10	25	57,5	2+2	Acciaio	PFO7007033	PFO7007034	
26	40	10	25	70	2+2	Acciaio	PFO7007035	PFO7007036	
30	28	10	25	57,5	2+2	Acciaio	PFO7007037	PFO7007038	
30	40	10	25	70	2+2	Acciaio	PFO7007039	PFO7007040	
35	28	10	25	57,5	2+2	Acciaio	PFO7007041	PFO7007042	
35	40	10	25	70	2+2	Acciaio	PFO7007043	PFO7007044	
35,5	28	10	25	57,5	2+2	Acciaio	PFO7007049	PFO7007050	
35,5	40	10	25	70	2+2	Acciaio	PFO7007051	PFO7007052	
40	28	10	25	57,5	2+2	Acciaio	PFO7007045	PFO7007046	
40	40	10	25	70	2+2	Acciaio	PFO7007047	PFO7007048	

FOUR LINE PF07501 - PF07502 - PF07503 - PF07504 - PF07505 - PF07506

PUNTA FORATRICE COMPONIBILE IN HW PER FORI CIECHI
CON RASANTI HW E CORPO IN ACCIAIO

4 FLUTE DOWEL DRILLS

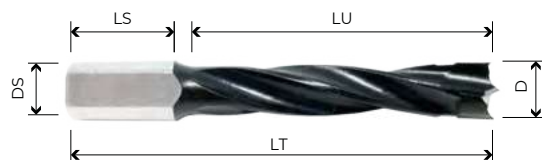

Realizzate con acciaio speciale ad alta resistenza, rivestimento in resina fluorocarbonica P.T.F.E di colore nero e arancio. Cuspide in HWM, punta di centraggio, 2 taglienti (Z2), 2 incursori ad affilatura negativa (Z2), 4 gole elicoidali. Attacco con piano di fissaggio e vite per regolazione assiale.

Super-strLENGTH steel, cutter portion coated with black or orange P.T.F.E.. HW head with precision balanced centre point, 2 HW precision ground cutting edges (Z2), 2 negatively ground spurs (V2), 4 spiral flutes. Parallel shank with driving flat and LENGTH adjusting screw.



PF07501		DIMENSIONI DIMENSIONS				ARTICOLI ITEMS		PREZZI €	
D DIAMETER	LT TOT. LENGTH	DS SHANK DIAMETER	LS SHANK LENGTH	LU USEFUL LENGTH	Z EFF ACTUAL TEETH	CORPO BODY	SX / LH CODICE / SKU	DX / RH CODICE / SKU	PRICE €
4	57,5	10	20	30	2	Acciaio / Steel	PF07501001	PF07501002	
5	57,5	10	20	30	2	Acciaio / Steel	PF07501003	PF07501004	
5,5	57,5	10	20	30	2	Acciaio / Steel	PF07501005	PF07501006	
6	57,5	10	20	30	2	Acciaio / Steel	PF07501007	PF07501008	
6,35(1/4")	57,5	10	20	30	2	Acciaio / Steel	PF07501009	PF07501010	
7	57,5	10	20	30	2	Acciaio / Steel	PF07501011	PF07501012	
8	57,5	10	20	30	2	Acciaio / Steel	PF07501013	PF07501014	
8,2	57,5	10	20	30	2	Acciaio / Steel	PF07501015	PF07501016	
9	57,5	10	20	30	2	Acciaio / Steel	PF07501017	PF07501018	
9,52(3/8")	57,5	10	20	30	2	Acciaio / Steel	PF07501019	PF07501020	
10	57,5	10	20	30	2	Acciaio / Steel	PF07501021	PF07501022	
10,5	57,5	10	20	30	2	Acciaio / Steel	PF07501023	PF07501024	
11	57,5	10	20	30	2	Acciaio / Steel	PF07501025	PF07501026	
12	57,5	10	20	30	2	Acciaio / Steel	PF07501027	PF07501028	
12,7(1/2")	57,5	10	20	30	2	Acciaio / Steel	PF07501029	PF07501030	
13	57,5	10	20	30	2	Acciaio / Steel	PF07501031	PF07501032	
14	57,5	10	20	30	2	Acciaio / Steel	PF07501033	PF07501034	
15	57,5	10	20	30	2	Acciaio / Steel	PF07501035	PF07501036	
16	57,5	10	20	30	2	Acciaio / Steel	PF07501037	PF07501038	

PF07502		DIMENSIONI DIMENSIONS				ARTICOLI ITEMS		PREZZI €	
D DIAMETER	LT TOT. LENGTH	DS SHANK DIAMETER	LS SHANK LENGTH	LU USEFUL LENGTH	Z EFF ACTUAL TEETH	CORPO BODY	SX / LH CODICE / SKU	DX / RH CODICE / SKU	PRICE €
4	70	10	20	43	2	Acciaio / Steel	PF07502001	PF07502002	
5	70	10	20	43	2	Acciaio / Steel	PF07502003	PF07502004	
5,5	70	10	20	43	2	Acciaio / Steel	PF07502005	PF07502006	
6	70	10	20	43	2	Acciaio / Steel	PF07502007	PF07502008	
6,35(1/4")	70	10	20	43	2	Acciaio / Steel	PF07502009	PF07502010	
7	70	10	20	43	2	Acciaio / Steel	PF07502011	PF07502012	
7,5	70	10	20	43	2	Acciaio / Steel	PF07502013	PF07502014	
8	70	10	20	43	2	Acciaio / Steel	PF07502015	PF07502016	
8,2	70	10	20	43	2	Acciaio / Steel	PF07502017	PF07502018	
9	70	10	20	43	2	Acciaio / Steel	PF07502019	PF07502020	
9,5(3,8")	70	10	20	43	2	Acciaio / Steel	PF07502021	PF07502022	
10	70	10	20	43	2	Acciaio / Steel	PF07502023	PF07502024	
10,5	70	10	20	43	2	Acciaio / Steel	PF07502025	PF07502026	
11	70	10	20	43	2	Acciaio / Steel	PF07502027	PF07502028	
12	70	10	20	43	2	Acciaio / Steel	PF07502029	PF07502030	
12,7(1/2")	70	10	20	43	2	Acciaio / Steel	PF07502031	PF07502032	
13	70	10	20	43	2	Acciaio / Steel	PF07502033	PF07502034	
14	70	10	20	43	2	Acciaio / Steel	PF07502035	PF07502036	
15	70	10	20	43	2	Acciaio / Steel	PF07502037	PF07502038	
16	70	10	20	43	2	Acciaio / Steel	PF07502039	PF07502040	

PFO7503		DIMENSIONI DIMENSIONS				ARTICOLI ITEMS		PREZZI €	
D	LT	DS	LS	LU	Z EFF	CORPO	SX / LH	DX / RH	PRICE €
DIAMETER	TOT. LENGTH	SHANK DIAMETER	SHANK LENGTH	USEFUL LENGTH	ACTUAL TEETH	BODY	CODICE / SKU	CODICE / SKU	
5	90	10	27	55	2	Acciaio / Steel	PFO7503001	PFO7503002	
6	90	10	27	55	2	Acciaio / Steel	PFO7503003	PFO7503004	
7	90	10	27	55	2	Acciaio / Steel	PFO7503005	PFO7503006	
8	90	10	27	55	2	Acciaio / Steel	PFO7503007	PFO7503008	
10	90	10	27	55	2	Acciaio / Steel	PFO7503009	PFO7503010	
12	90	10	27	55	2	Acciaio / Steel	PFO7503011	PFO7503012	

PFO7504		DIMENSIONI DIMENSIONS				ARTICOLI ITEMS		PREZZI €	
D	LT	DS	LS	LU	Z EFF	CORPO	SX / LH	DX / RH	PRICE €
DIAMETER	TOT. LENGTH	SHANK DIAMETER	SHANK LENGTH	USEFUL LENGTH	ACTUAL TEETH	BODY	CODICE / SKU	CODICE / SKU	
5	105	10	27	70	2	Acciaio / Steel	PFO7504001	PFO7504002	
6	105	10	27	70	2	Acciaio / Steel	PFO7504003	PFO7504004	
7	105	10	27	70	2	Acciaio / Steel	PFO7504005	PFO7504006	
8	105	10	27	70	2	Acciaio / Steel	PFO7504007	PFO7504008	
10	105	10	27	70	2	Acciaio / Steel	PFO7504009	PFO7504010	
12	105	10	27	70	2	Acciaio / Steel	PFO7504011	PFO7504012	

PFO7505		DIMENSIONI DIMENSIONS				ARTICOLI ITEMS		PREZZI €	
D	LT	DS	LS	LU	Z EFF	CORPO	SX / LH	DX / RH	PRICE €
DIAMETER	TOT. LENGTH	SHANK DIAMETER	SHANK LENGTH	USEFUL LENGTH	ACTUAL TEETH	BODY	CODICE / SKU	CODICE / SKU	
4	55,5	8	20	40	2	Acciaio / Steel	PFO7505001	PFO7505002	
5	55,5	8	20	40	2	Acciaio / Steel	PFO7505003	PFO7505004	
5,55	55,5	8	20	40	2	Acciaio / Steel	PFO7505005	PFO7505006	
6	55,5	8	20	40	2	Acciaio / Steel	PFO7505007	PFO7505008	
6,35	55,5	8	20	40	2	Acciaio / Steel	PFO7505009	PFO7505010	
7	55,5	8	20	40	2	Acciaio / Steel	PFO7505011	PFO7505012	
8	55,5	8	20	40	2	Acciaio / Steel	PFO7505013	PFO7505014	
9	55,5	8	20	40	2	Acciaio / Steel	PFO7505015	PFO7505016	
9,52	55,5	8	20	40	2	Acciaio / Steel	PFO7505017	PFO7505018	
10	55,5	8	20	40	2	Acciaio / Steel	PFO7505019	PFO7505020	
11	55,5	8	20	40	2	Acciaio / Steel	PFO7505021	PFO7505022	
12	55,5	8	20	40	2	Acciaio / Steel	PFO7505023	PFO7505024	

PFO7506		DIMENSIONI DIMENSIONS				ARTICOLI ITEMS		PREZZI €	
D	LT	DS	LS	LU	Z EFF	CORPO	SX / LH	DX / RH	PRICE €
DIAMETER	TOT. LENGTH	SHANK DIAMETER	SHANK LENGTH	USEFUL LENGTH	ACTUAL TEETH	BODY	CODICE / SKU	CODICE / SKU	
4	67	8	20	40	2	Acciaio / Steel	PFO7506001	PFO7506002	
5	67	8	20	40	2	Acciaio / Steel	PFO7506003	PFO7506004	
5,55	67	8	20	40	2	Acciaio / Steel	PFO7506005	PFO7506006	
6	67	8	20	40	2	Acciaio / Steel	PFO7506007	PFO7506008	
6,35	67	8	20	40	2	Acciaio / Steel	PFO7506009	PFO7506010	
7	67	8	20	40	2	Acciaio / Steel	PFO7506011	PFO7506012	
8	67	8	20	40	2	Acciaio / Steel	PFO7506013	PFO7506014	
9	67	8	20	40	2	Acciaio / Steel	PFO7506015	PFO7506016	
9,52	67	8	20	40	2	Acciaio / Steel	PFO7506017	PFO7506018	
10	67	8	20	40	2	Acciaio / Steel	PFO7506019	PFO7506020	
11	67	8	20	40	2	Acciaio / Steel	PFO7506021	PFO7506022	
12	67	8	20	40	2	Acciaio / Steel	PFO7506023	PFO7506024	

TWO LINE PF07507 - PF07508 - PF07509

PUNTA FORATRICE COMPONIBILE HW PER FORI CIECHI CON RASANTI HW E CORPO IN ACCIAIO

2 FLUTE DOWEL DRILLS

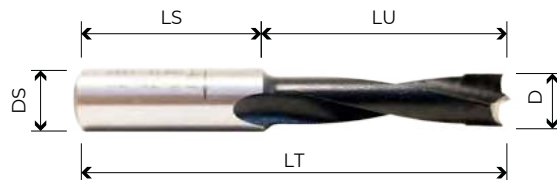

Realizzate con acciaio speciale ad alta resistenza, rivestimento in resina fluorocarbonica P.T.F.E di colore nero e arancio. Cuspide in HWM, punta di centraggio, 2 taglienti (Z2), 2 incisori ad affilatura negativa (V2), 2 gole elicoidali. Attacco con piano di fissaggio e vite per regolazione assiale.

Super-strLENGTH steel, Spiral portion coated with orange or black P.T.F.E.. HW head with precision balanced centre point, 2 HW precision ground cutting edges (Z2), 2 negatively ground spurs (V2), 2 spiral flutes. Parallel shank with driving flat and LENGTH adjusting screw.



PF07507		DIMENSIONI DIMENSIONS			ARTICOLI ITEMS		PREZZI €		
D	LT	DS	LS	LU	Z EFF	CORPO	SX / LH	DX / RH	PRICE €
DIAMETER	TOT. LENGTH	SHANK DIAMETER	SHANK LENGTH	USEFUL LENGTH	ACTUAL TEETH	BODY	CODICE / SKU	CODICE / SKU	
4	57,5	10	27	27	2	Acciaio / Steel	PF07507001	PF07507002	
4,5	57,5	10	27	27	2	Acciaio / Steel	PF07507003	PF07507004	
4,76	57,5	10	27	27	2	Acciaio / Steel	PF07507005	PF07507006	
5	57,5	10	27	27	2	Acciaio / Steel	PF07507007	PF07507008	
5,1	57,5	10	27	27	2	Acciaio / Steel	PF07507009	PF07507010	
5,2	57,5	10	27	27	2	Acciaio / Steel	PF07507011	PF07507012	
5,55	57,5	10	27	27	2	Acciaio / Steel	PF07507013	PF07507014	
6	57,5	10	27	27	2	Acciaio / Steel	PF07507015	PF07507016	
6,35 (1/4")	57,5	10	27	27	2	Acciaio / Steel	PF07507017	PF07507018	
6,5	57,5	10	27	27	2	Acciaio / Steel	PF07507019	PF07507020	
7	57,5	10	27	27	2	Acciaio / Steel	PF07507021	PF07507022	
8	57,5	10	27	27	2	Acciaio / Steel	PF07507023	PF07507024	
8,2	57,5	10	27	27	2	Acciaio / Steel	PF07507025	PF07507026	
9	57,5	10	27	27	2	Acciaio / Steel	PF07507027	PF07507028	
9,52 (3,8")	57,5	10	27	27	2	Acciaio / Steel	PF07507029	PF07507030	
10	57,5	10	27	27	2	Acciaio / Steel	PF07507031	PF07507032	
11	57,5	10	27	27	2	Acciaio / Steel	PF07507033	PF07507034	
12	57,5	10	27	27	2	Acciaio / Steel	PF07507035	PF07507036	
12,7 (1/2")	57,5	10	27	27	2	Acciaio / Steel	PF07507037	PF07507038	
13	57,5	10	27	27	2	Acciaio / Steel	PF07507039	PF07507040	
14	57,5	10	27	27	2	Acciaio / Steel	PF07507041	PF07507042	
15	57,5	10	27	27	2	Acciaio / Steel	PF07507043	PF07507044	
16	57,5	10	27	27	2	Acciaio / Steel	PF07507045	PF07507046	

PF07508		DIMENSIONI DIMENSIONS			ARTICOLI ITEMS		PREZZI €		
D	LT	DS	LS	LU	Z EFF	CORPO	SX / LH	DX / RH	PRICE €
DIAMETER	TOT. LENGTH	SHANK DIAMETER	SHANK LENGTH	USEFUL LENGTH	ACTUAL TEETH	BODY	CODICE / SKU	CODICE / SKU	
4	70	10	30	35	2	Acciaio / Steel	PF07508001	PF07508002	
4,5	70	10	30	35	2	Acciaio / Steel	PF07508003	PF07508004	
4,76	70	10	30	35	2	Acciaio / Steel	PF07508005	PF07508006	
5	70	10	30	35	2	Acciaio / Steel	PF07508007	PF07508008	
5,1	70	10	30	35	2	Acciaio / Steel	PF07508009	PF07508010	
5,2	70	10	30	35	2	Acciaio / Steel	PF07508011	PF07508012	
5,55	70	10	30	35	2	Acciaio / Steel	PF07508013	PF07508014	
6	70	10	30	35	2	Acciaio / Steel	PF07508015	PF07508016	
6,35 (1/4")	70	10	30	35	2	Acciaio / Steel	PF07508017	PF07508018	
6,5	70	10	30	35	2	Acciaio / Steel	PF07508019	PF07508020	
7	70	10	30	35	2	Acciaio / Steel	PF07508021	PF07508022	
8	70	10	30	35	2	Acciaio / Steel	PF07508023	PF07508024	
8,2	70	10	30	35	2	Acciaio / Steel	PF07508025	PF07508026	
9	70	10	30	35	2	Acciaio / Steel	PF07508027	PF07508028	
9,52 (3,8")	70	10	30	35	2	Acciaio / Steel	PF07508029	PF07508030	
10	70	10	30	35	2	Acciaio / Steel	PF07508031	PF07508032	
11	70	10	30	35	2	Acciaio / Steel	PF07508033	PF07508034	



PFO7508		DIMENSIONI DIMENSIONS				ARTICOLI ITEMS				PREZZI €
D	LT	DS	LS	LU	Z EFF	CORPO	SX / LH	DX / RH	PRICE €	
DIAMETER	TOT. LENGTH	SHANK DIAMETER	SHANK LENGTH	USEFUL LENGTH	ACTUAL TEETH	BODY	CODICE / SKU	CODICE / SKU		
12	70	10	30	35	2	Acciaio / Steel	PFO7508035	PFO7508036		
12,7 (1/2")	70	10	30	35	2	Acciaio / Steel	PFO7508037	PFO7508038		
13	70	10	30	35	2	Acciaio / Steel	PFO7508039	PFO7508040		
14	70	10	30	35	2	Acciaio / Steel	PFO7508041	PFO7508042		
15	70	10	30	35	2	Acciaio / Steel	PFO7508043	PFO7508044		
16	70	10	30	35	2	Acciaio / Steel	PFO7508045	PFO7508046		

PFO7509		DIMENSIONI DIMENSIONS				ARTICOLI ITEMS				PREZZI €
D	LT	DS	LS	LU	Z EFF	CORPO	SX / LH	DX / RH	PRICE €	
DIAMETER	TOT. LENGTH	SHANK DIAMETER	SHANK LENGTH	USEFUL LENGTH	ACTUAL TEETH	BODY	CODICE / SKU	CODICE / SKU		
5	77	10	27	44	2	Acciaio / Steel	PFO7509001	PFO7509002		
6	77	10	27	44	2	Acciaio / Steel	PFO7509003	PFO7509004		
7	77	10	27	44	2	Acciaio / Steel	PFO7509005	PFO7509006		
8	77	10	27	44	2	Acciaio / Steel	PFO7509007	PFO7509008		
10	77	10	27	44	2	Acciaio / Steel	PFO7509009	PFO7509010		
12	77	10	27	44	2	Acciaio / Steel	PFO7509011	PFO7509012		

R-LINE PFO7510 - PFO7511

PUNTA FORATRICE CON ATTACCO RAPIDO IN HW
PER FORI CIECHI CON RASANTI HW E CORPO IN ACCIAIO

DOWEL DRILLS

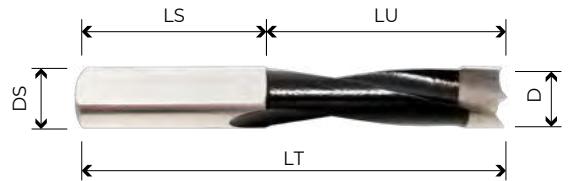

Attacco in acciaio speciale ad alta resistenza. Affilatura piatta senza incisori, corpo elicoidale in metallo duro super micrograno di qualità superiore. 2 taglienti(Z2) + 2 incisori ad affilatura rinforzata (V2), 2 gole elicoidali. Attacco con piano di fissaggio e vite per regolazione assiale.

Premium quality super strLENGTH steel for improved resistance and durability. Premium quality HWM spiral portion. 2 cutting edges (Z2) + 2 negatively ground spurs (V2), 2 spiral flutes, parallel shank with driving flat and adjustable screw LENGTH. Recommended feed speed 1÷4m/minute -RPM 6000.



PFO7510		DIMENSIONI DIMENSIONS				ARTICOLI ITEMS				PREZZI €
D	LT	DS	LS	LU	Z EFF	CORPO	SX / LH	DX / RH	PRICE €	
DIAMETER	TOT. LENGTH	SHANK DIAMETER	SHANK LENGTH	USEFUL LENGTH	ACTUAL TEETH	BODY	CODICE / SKU	CODICE / SKU		
5	57,5	10	27	30	2	Acciaio / Steel	PFO7510001	PFO7510002		
6	57,5	10	27	30	2	Acciaio / Steel	PFO7510003	PFO7510004		
7	57,5	10	27	30	2	Acciaio / Steel	PFO7510005	PFO7510006		
8	57,5	10	27	30	2	Acciaio / Steel	PFO7510007	PFO7510008		
9	57,5	10	27	30	2	Acciaio / Steel	PFO7510009	PFO7510010		
10	57,5	10	27	30	2	Acciaio / Steel	PFO7510011	PFO7510012		
12	57,5	10	27	30	2	Acciaio / Steel	PFO7510013	PFO7510014		

PFO7511		DIMENSIONI DIMENSIONS				ARTICOLI ITEMS				PREZZI €
D	LT	DS	LS	LU	Z EFF	CORPO	SX / LH	DX / RH	PRICE €	
DIAMETER	TOT. LENGTH	SHANK DIAMETER	SHANK LENGTH	USEFUL LENGTH	ACTUAL TEETH	BODY	CODICE / SKU	CODICE / SKU		
5	70	10	30	35	2	Acciaio / Steel	PFO7511001	PFO7511002		
6	70	10	30	35	2	Acciaio / Steel	PFO7511003	PFO7511004		
7	70	10	30	35	2	Acciaio / Steel	PFO7511005	PFO7511006		
8	70	10	30	35	2	Acciaio / Steel	PFO7511007	PFO7511008		
9	70	10	30	35	2	Acciaio / Steel	PFO7511009	PFO7511010		
10	70	10	30	35	2	Acciaio / Steel	PFO7511011	PFO7511012		
12	70	10	30	35	2	Acciaio / Steel	PFO7511013	PFO7511014		

POWER LINE PF07512 - PF07513

PUNTA FORATRICE IN HW CON ATTACCO RAPIDO
PER FORI CIECHI CON RASANTI RAGGIATI E CORPO HW

SOLID CARBIDE DWEL DRILLS

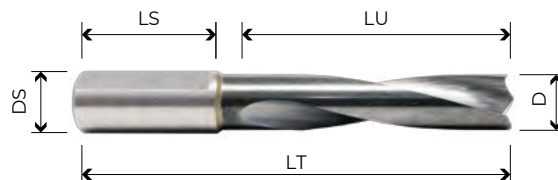

Attacco in acciaio speciale ad alta resistenza. Affilatura piatta senza incisori, corpo elicoidale in metallo duro super micrograno di qualità superiore. 2 taglienti (Z2) + 2 incisori ad affilatura rinforzata (V2), 2 gole elicoidali. Attacco con piano di fissaggio e vite per regolazione assiale.

Premium quality super strLENGTH steel for improved resistance and durability. Premium quality HWM spiral portion. 2 cutting edges (Z2) + 2 negatively ground spurs (V2), 2 spiral flutes. Parallel shank with driving flat and adjustable screw LENGTH. Recommended feed speed 1÷4m/minute –RPM 6000.



PFO7512		DIMENSIONI		DIMENSIONS		ARTICOLI		ITEMS		PREZZI €
D	LT	DS	LS	LU	Z EFF	CORPO	SX / LH	DX / RH		PRICE €
DIAMETER	TOT. LENGTH	SHANK DIAMETER	SHANK LENGTH	USEFUL LENGTH	ACTUAL TEETH	BODY	CODICE / SKU	CODICE / SKU		
1,3	57,5	10	30	5	2	HW	PFO7512001	PFO7512002		
2	57,5	10	27	12	2	HW	PFO7512003	PFO7512004		
3	57,5	10	25	18	2	HW	PFO7512005	PFO7512006		
4	57,5	10	25	20	2	HW	PFO7512007	PFO7512008		
5	57,5	10	27	22	2	HW	PFO7512009	PFO7512010		
6	57,5	10	27	22	2	HW	PFO7512011	PFO7512012		
6,35	57,5	10	27	22	2	HW	PFO7512013	PFO7512014		
8	57,5	10	25	22	2	HW	PFO7512015	PFO7512016		
10	57,5	10	25	22	2	HW	PFO7512017	PFO7512018		

PFO7513		DIMENSIONI		DIMENSIONS		ARTICOLI		ITEMS		PREZZI €
D	LT	DS	LS	LU	Z EFF	CORPO	SX / LH	DX / RH		PRICE €
DIAMETER	TOT. LENGTH	SHANK DIAMETER	SHANK LENGTH	USEFUL LENGTH	ACTUAL TEETH	BODY	CODICE / SKU	CODICE / SKU		
1,3	70	10	30	5	2	HW	PFO7513017	PFO7513018		
2	70	10	30	12	2	HW	PFO7513001	PFO7513002		
3	70	10	30	18	2	HW	PFO7513003	PFO7513004		
4	70	10	30	27	2	HW	PFO7513005	PFO7513006		
5	70	10	30	30	2	HW	PFO7513007	PFO7513008		
6	70	10	30	30	2	HW	PFO7513009	PFO7513010		
6,35	70	10	30	30	2	HW	PFO7513011	PFO7513012		
8	70	10	30	37	2	HW	PFO7513013	PFO7513014		
10	70	10	30	37	2	HW	PFO7513015	PFO7513016		

PUNTA AMBIDESTRA PER LA PREFORATURA DEI PANNELLI
USEFUL FOR RH OR LH ROTATION

EXTREME PF07514

PUNTA FORATRICE IN HWM MICROGRANA
PER FORATRICE AD ATTACCO RAPIDO

SOLID CARBIDE DOWER DRILL HWM

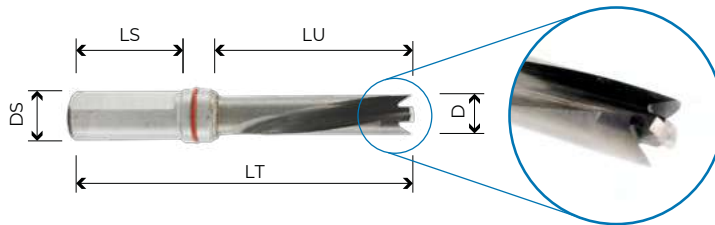

Attacco in acciaio speciale ad alta resistenza. Affilatura piatta senza incisori, corpo elicoidale in metallo duro super micrograno di qualità superiore. 2 taglienti (Z2) + 2 incisori ad affilatura rinforzata (V2), 2 gole elicoidali. Attacco con piano di fissaggio e vite per regolazione assiale.

Premium quality super strength steel for improved resistance and durability. Premium quality HWM spiral portion. 2 cutting edges (Z2) + 2 negatively ground spurs (V2), 2 spiral flutes, parallel shank with driving flat and adjustable screw length. Recommended feed speed 1÷ 4m/minute -RPM 6000.



PF07514		DIMENSIONI DIMENSIONS				ARTICOLI ITEMS				PREZZI €
D	LT	DS	LS	LU	Z EFF	CORPO	SX / LH	DX / RH	PRICE €	
DIAMETER	TOT. LENGTH	SHANK DIAMETER	SHANK LENGTH	USEFUL LENGTH	ACTUAL TEETH	BODY	CODICE / SKU	CODICE / SKU		
4	70	10	27	30	2	HWM	PFO7514001	PFO7514002		
5	70	10	27	30	2	HWM	PFO7514003	PFO7514004		
6	70	10	27	30	2	HWM	PFO7514005	PFO7514006		
8	70	10	27	30	2	HWM	PFO7514007	PFO7514008		
8,2	70	10	27	30	2	HWM	PFO7514009	PFO7514010		

PLCH PF07515 - PF07516 - PF07517

PUNTA FORATRICE PER CERNIERE AD ATTACCO RAPIDO
HINGE BORING BITS

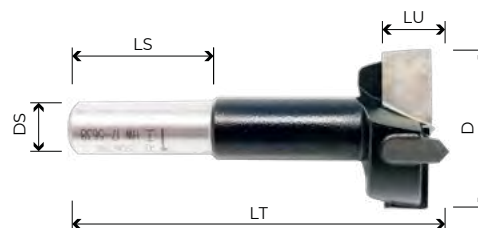

Realizzate con acciaio speciale ad alta resistenza. Rivestimento in resina fluorocarbonica P.T.F.E di colore nero e arancio. Punta di centraggio HW, 2 taglienti (Z2), 2 incisori ad affilatura negativa (V2). Attacco con piano di fissaggio e vite per regolazione assiale.

Super-strength steel. Cutter portion coated with orange or black P.T.F.E., HW head with precision balanced centre point. 2 HW precision ground cutting edges (Z2), 2 negatively ground spurs (V2). Parallel shank with driving flat and LENGTH adjusting screw.



PF07515		DIMENSIONI DIMENSIONS				ARTICOLI ITEMS				PREZZI €
D	LT	DS	LS	LU	Z EFF	CORPO	SX / LH	DX / RH	PRICE €	
DIAMETER	TOT. LENGTH	SHANK DIAMETER	SHANK LENGTH	USEFUL LENGTH	ACTUAL TEETH	BODY	CODICE / SKU	CODICE / SKU		
14	57,5	10	25	32	2+2	Acciaio / Steel	PFO7515001	PFO7515002		
15	57,5	10	25	32	2+2	Acciaio / Steel	PFO7515003	PFO7515004		
16	57,5	10	25	32	2+2	Acciaio / Steel	PFO7515005	PFO7515006		
17	57,5	10	25	32	2+2	Acciaio / Steel	PFO7515007	PFO7515008		
18	57,5	10	25	32	2+2	Acciaio / Steel	PFO7515009	PFO7515010		
19	57,5	10	25	32	2+2	Acciaio / Steel	PFO7515011	PFO7515012		
20	57,5	10	25	32	2+2	Acciaio / Steel	PFO7515013	PFO7515014		
22	57,5	10	25	32	2+2	Acciaio / Steel	PFO7515015	PFO7515016		
24	57,5	10	25	32	2+2	Acciaio / Steel	PFO7515017	PFO7515018		
25	57,5	10	25	32	2+2	Acciaio / Steel	PFO7515019	PFO7515020		
26	57,5	10	25	32	2+2	Acciaio / Steel	PFO7515021	PFO7515022		
28	57,5	10	25	32	2+2	Acciaio / Steel	PFO7515023	PFO7515024		

PFO7515		DIMENSIONI DIMENSIONS				ARTICOLI ITEMS				PREZZI €
D	LT	DS	LS	LU	Z EFF	CORPO	SX / LH	DX / RH	PRICE €	
DIAMETER	TOT. LENGTH	SHANK DIAMETER	SHANK LENGTH	USEFUL LENGTH	ACTUAL TEETH	BODY	CODICE / SKU	CODICE / SKU		
30	57,5	10	25	32	2+2	Acciaio / Steel	PFO7515025	PFO7515026		
32	57,5	10	25	32	2+2	Acciaio / Steel	PFO7515027	PFO7515028		
34	57,5	10	25	32	2+2	Acciaio / Steel	PFO7515029	PFO7515030		
35	57,5	10	25	32	2+2	Acciaio / Steel	PFO7515031	PFO7515032		
36	57,5	10	25	32	2+2	Acciaio / Steel	PFO7515033	PFO7515034		
38	57,5	10	25	32	2+2	Acciaio / Steel	PFO7515035	PFO7515036		
40	57,5	10	25	32	2+2	Acciaio / Steel	PFO7515037	PFO7515038		
42	57,5	10	25	32	2+2	Acciaio / Steel	PFO7515039	PFO7515040		
45	57,5	10	25	32	2+2	Acciaio / Steel	PFO7515041	PFO7515042		
50	57,5	10	25	32	2+2	Acciaio / Steel	PFO7515043	PFO7515044		
55	57,5	10	25	32	2+2	Acciaio / Steel	PFO7515045	PFO7515046		
60	57,5	10	25	32	2+2	Acciaio / Steel	PFO7515047	PFO7515048		

PFO7516		DIMENSIONI DIMENSIONS				ARTICOLI ITEMS				PREZZI €
D	LT	DS	LS	LU	Z EFF	CORPO	SX / LH	DX / RH	PRICE €	
DIAMETER	TOT. LENGTH	SHANK DIAMETER	SHANK LENGTH	USEFUL LENGTH	ACTUAL TEETH	BODY	CODICE / SKU	CODICE / SKU		
14	70	10	25	45	2+2	Acciaio / Steel	PFO7516001	PFO7516002		
15	70	10	25	45	2+2	Acciaio / Steel	PFO7516003	PFO7516004		
16	70	10	25	45	2+2	Acciaio / Steel	PFO7516005	PFO7516006		
17	70	10	25	45	2+2	Acciaio / Steel	PFO7516007	PFO7516008		
18	70	10	25	45	2+2	Acciaio / Steel	PFO7516009	PFO7516010		
19	70	10	25	45	2+2	Acciaio / Steel	PFO7516011	PFO7516012		
20	70	10	25	45	2+2	Acciaio / Steel	PFO7516013	PFO7516014		
22	70	10	25	45	2+2	Acciaio / Steel	PFO7516015	PFO7516016		
24	70	10	25	45	2+2	Acciaio / Steel	PFO7516017	PFO7516018		
25	70	10	25	45	2+2	Acciaio / Steel	PFO7516019	PFO7516020		
26	70	10	25	45	2+2	Acciaio / Steel	PFO7516021	PFO7516022		
28	70	10	25	45	2+2	Acciaio / Steel	PFO7516023	PFO7516024		
30	70	10	25	45	2+2	Acciaio / Steel	PFO7516025	PFO7516026		
32	70	10	25	45	2+2	Acciaio / Steel	PFO7516027	PFO7516028		
34	70	10	25	45	2+2	Acciaio / Steel	PFO7516029	PFO7516030		
35	70	10	25	45	2+2	Acciaio / Steel	PFO7516031	PFO7516032		
36	70	10	25	45	2+2	Acciaio / Steel	PFO7516033	PFO7516034		
38	70	10	25	45	2+2	Acciaio / Steel	PFO7516035	PFO7516036		
40	70	10	25	45	2+2	Acciaio / Steel	PFO7516037	PFO7516038		
42	70	10	25	45	2+2	Acciaio / Steel	PFO7516039	PFO7516040		
45	70	10	25	45	2+2	Acciaio / Steel	PFO7516041	PFO7516042		
50	70	10	25	45	2+2	Acciaio / Steel	PFO7516043	PFO7516044		
55	70	10	25	45	2+2	Acciaio / Steel	PFO7516045	PFO7516046		
60	70	10	25	45	2+2	Acciaio / Steel	PFO7516047	PFO7516048		

PFO7517		DIMENSIONI DIMENSIONS				ARTICOLI ITEMS				PREZZI €
D	LT	DS	LS	LU	Z EFF	CORPO	SX / LH	DX / RH	PRICE €	
DIAMETER	TOT. LENGTH	SHANK DIAMETER	SHANK LENGTH	USEFUL LENGTH	ACTUAL TEETH	BODY	CODICE / SKU	CODICE / SKU		
14	90	10	60	45	2+2	Acciaio / Steel	PFO7517001	PFO7517002		
15	90	10	60	45	2+2	Acciaio / Steel	PFO7517003	PFO7517004		
16	90	10	60	45	2+2	Acciaio / Steel	PFO7517005	PFO7517006		
17	90	10	60	45	2+2	Acciaio / Steel	PFO7517007	PFO7517008		
18	90	10	60	45	2+2	Acciaio / Steel	PFO7517009	PFO7517010		
19	90	10	60	45	2+2	Acciaio / Steel	PFO7517011	PFO7517012		
20	90	10	60	45	2+2	Acciaio / Steel	PFO7517013	PFO7517014		
22	90	10	60	45	2+2	Acciaio / Steel	PFO7517015	PFO7517016		
24	90	10	60	45	2+2	Acciaio / Steel	PFO7517017	PFO7517018		
25	90	10	60	45	2+2	Acciaio / Steel	PFO7517019	PFO7517020		
26	90	10	60	45	2+2	Acciaio / Steel	PFO7517021	PFO7517022		
28	90	10	60	45	2+2	Acciaio / Steel	PFO7517023	PFO7517024		
30	90	10	60	45	2+2	Acciaio / Steel	PFO7517025	PFO7517026		
32	90	10	60	45	2+2	Acciaio / Steel	PFO7517027	PFO7517028		
34	90	10	60	45	2+2	Acciaio / Steel	PFO7517029	PFO7517030		
35	90	10	60	45	2+2	Acciaio / Steel	PFO7517031	PFO7517032		
36	90	10	60	45	2+2	Acciaio / Steel	PFO7517033	PFO7517034		
38	90	10	60	45	2+2	Acciaio / Steel	PFO7517035	PFO7517036		
40	90	10	60	45	2+2	Acciaio / Steel	PFO7517037	PFO7517038		
42	90	10	60	45	2+2	Acciaio / Steel	PFO7517039	PFO7517040		
45	90	10	60	45	2+2	Acciaio / Steel	PFO7517041	PFO7517042		
50	90	10	60	45	2+2	Acciaio / Steel	PFO7517043	PFO7517044		
55	90	10	60	45	2+2	Acciaio / Steel	PFO7517045	PFO7517046		
60	90	10	60	45	2+2	Acciaio / Steel	PFO7517047	PFO7517048		

FLINE L PF07518 - PF07519 - PF07520

PUNTA FORATRICE componibile in HW a lancia
per fori passanti con corpo in acciaio

HW THROUGH HOLES DRILLING BIT

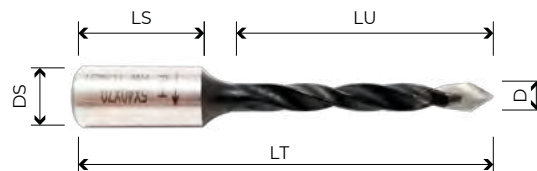

Realizzate con acciaio speciale ad alta resistenza. Rivestimento in resina fluorocarbonica P.T.F.E. nero e arancio. Cuspide in HWM, 2 taglienti (Z2), 4 gole elicoidali.

Super-strLENGTH steel. Spiral portion coated with orange or black P.T.F.E., HW head with precision balanced centre point. 2 precision ground cutting edges (Z2), 4 spiral flutes. Parallel shank with driving flat and LENGTH adjusting screw.



PFO7518		DIMENSIONI DIMENSIONS				ARTICOLI ITEMS		PREZZI €	
D	LT	DS	LS	LU	Z EFF	CORPO	SX / LH	DX / RH	PRICE €
DIAMETER	TOT. LENGTH	SHANK DIAMETER	SHANK LENGTH	USEFUL LENGTH	ACTUAL TEETH	BODY	CODICE / SKU	CODICE / SKU	
5	57,5	10	20	30	2	Acciaio / Steel	PFO7518001	PFO7518002	
8	57,5	10	20	30	2	Acciaio / Steel	PFO7518003	PFO7518004	

PFO7519		DIMENSIONI DIMENSIONS				ARTICOLI ITEMS		PREZZI €	
D	LT	DS	LS	LU	Z EFF	CORPO	SX / LH	DX / RH	PRICE €
DIAMETER	TOT. LENGTH	SHANK DIAMETER	SHANK LENGTH	USEFUL LENGTH	ACTUAL TEETH	BODY	CODICE / SKU	CODICE / SKU	
4	70	10	20	30	2	Acciaio / Steel	PFO7519001	PFO7519002	
5	70	10	20	30	2	Acciaio / Steel	PFO7519003	PFO7519004	
6	70	10	20	30	2	Acciaio / Steel	PFO7519005	PFO7519006	
7	70	10	20	30	2	Acciaio / Steel	PFO7519009	PFO7519010	
8	70	10	20	30	2	Acciaio / Steel	PFO7519011	PFO7519012	
9	70	10	20	30	2	Acciaio / Steel	PFO7519013	PFO7519014	
10	70	10	20	30	2	Acciaio / Steel	PFO7519015	PFO7519016	
12	70	10	20	30	2	Acciaio / Steel	PFO7519017	PFO7519018	

PFO7520		DIMENSIONI DIMENSIONS				ARTICOLI ITEMS		PREZZI €	
D	LT	DS	LS	LU	Z EFF	CORPO	SX / LH	DX / RH	PRICE €
DIAMETER	TOT. LENGTH	SHANK DIAMETER	SHANK LENGTH	USEFUL LENGTH	ACTUAL TEETH	BODY	CODICE / SKU	CODICE / SKU	
5	115	10	30	70	2	Acciaio / Steel	PFO7520001	PFO7520002	
6	115	10	30	70	2	Acciaio / Steel	PFO7520003	PFO7520004	
8	115	10	30	70	2	Acciaio / Steel	PFO7520005	PFO7520006	
10	115	10	30	70	2	Acciaio / Steel	PFO7520007	PFO7520008	

PUNTE FORATRICI
DRILLING BITS

PFO

TLINE L PF07521 - PF07522 - PF07523

PUNTA FORATRICE componibile in HW a lancia
per fori passanti con corpo in acciaio

HW THROUGH HOLES DRILLING BIT

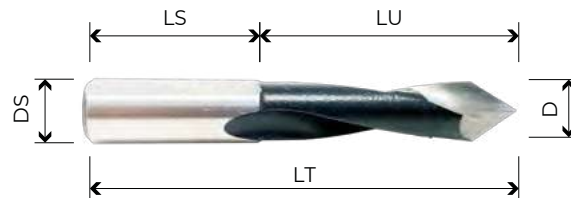

Realizzate con acciaio speciale ad alta resistenza. Rivestimento in resina fluorocarbonica P.T.F.E. nero e arancio. Cuspide in HWM, 2 taglienti (Z2), 4 gole elicoidali. Attacco con piano di fissaggio e vite per regolazioni assiale.

Super-strLENGTH steel. Spiral portion coated with orange or black P.T.F.E., HW head with precision balanced centre point. 2 precision ground cutting edges (Z2), 4 spiral flutes. Parallel shank with driving flat and LENGTH adjusting screw.



PF07521		DIMENSIONI DIMENSIONS				ARTICOLI ITEMS		PREZZI €	
D	LT	DS	LS	LU	Z EFF	CORPO	SX / LH	DX / RH	PRICE €
DIAMETER	TOT. LENGTH	SHANK DIAMETER	SHANK LENGTH	USEFUL LENGTH	ACTUAL TEETH	BODY	CODICE / SKU	CODICE / SKU	
4	58	10	25	25	2	Acciaio / Steel	PF07521001	PF07521002	
5	58	10	25	25	2	Acciaio / Steel	PF07521003	PF07521004	
6	58	10	25	25	2	Acciaio / Steel	PF07521005	PF07521006	
6,35	58	10	25	25	2	Acciaio / Steel	PF07521007	PF07521008	
7	58	10	25	25	2	Acciaio / Steel	PF07521009	PF07521010	
8	58	10	25	25	2	Acciaio / Steel	PF07521011	PF07521012	
9	58	10	25	25	2	Acciaio / Steel	PF07521013	PF07521014	
10	58	10	25	25	2	Acciaio / Steel	PF07521015	PF07521016	
12	58	10	25	25	2	Acciaio / Steel	PF07521017	PF07521018	

PF07522		DIMENSIONI DIMENSIONS				ARTICOLI ITEMS		PREZZI €	
D	LT	DS	LS	LU	Z EFF	CORPO	SX / LH	DX / RH	PRICE €
DIAMETER	TOT. LENGTH	SHANK DIAMETER	SHANK LENGTH	USEFUL LENGTH	ACTUAL TEETH	BODY	CODICE / SKU	CODICE / SKU	
4	70	10	25	35	2	Acciaio / Steel	PF07522001	PF07522002	
5	70	10	25	35	2	Acciaio / Steel	PF07522003	PF07522004	
6	70	10	25	35	2	Acciaio / Steel	PF07522005	PF07522006	
6,35	70	10	25	35	2	Acciaio / Steel	PF07522007	PF07522008	
7	70	10	25	35	2	Acciaio / Steel	PF07522009	PF07522010	
8	70	10	25	35	2	Acciaio / Steel	PF07522011	PF07522012	
9	70	10	25	35	2	Acciaio / Steel	PF07522013	PF07522014	
10	70	10	25	35	2	Acciaio / Steel	PF07522015	PF07522016	
12	70	10	25	35	2	Acciaio / Steel	PF07522017	PF07522018	

PF07523		DIMENSIONI DIMENSIONS				ARTICOLI ITEMS		PREZZI €	
D	LT	DS	LS	LU	Z EFF	CORPO	SX / LH	DX / RH	PRICE €
DIAMETER	TOT. LENGTH	SHANK DIAMETER	SHANK LENGTH	USEFUL LENGTH	ACTUAL TEETH	BODY	CODICE / SKU	CODICE / SKU	
5	77	10	25	40	2	Acciaio / Steel	PF07523001	PF07523002	
6	77	10	25	40	2	Acciaio / Steel	PF07523003	PF07523004	
8	77	10	25	40	2	Acciaio / Steel	PF07523005	PF07523006	
10	77	10	25	40	2	Acciaio / Steel	PF07523007	PF07523008	
12	77	10	25	40	2	Acciaio / Steel	PF07523009	PF07523010	

TLINE 2L PFO7524 - PFO7525

PUNTA FORATRICE IN HW A LANCIA
CON DOPPIO SMUSSO E CORPO IN ACCIAIO

HW THROUGH HOLES DRILLING BIT
WITH SPECIAL SHARPENING

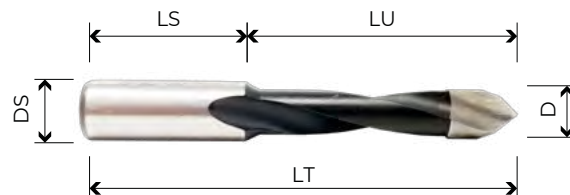

Realizzate con acciaio speciale ad alta resistenza. Cuspide in metallo duro super micrograno di qualità superiore. Rivestimento in resina fluorocarbonica P.T.F.E di colore nero e arancio. 2 taglienti a doppio angolo (Z2), 2 gole elicoidali. Attacco con piano di fissaggio e vite per regolazione assiale.

Premium quality super-strLENGTH steel. Spiral portion coated with orange or black P.T.F.E., extra-fine micro-grain carbide spiral portion with centre point. HW head with precision balanced centre point. 2 precision ground cutting edges (Z2), Double angle, 2 spiral flutes. Parallel shank with driving flat and adjustable screw LENGTH.



PFO7524		DIMENSIONI DIMENSIONS				ARTICOLI ITEMS		PREZZI €	
D	LT	DS	LS	LU	Z EFF	CORPO	SX / LH	DX / RH	PRICE €
DIAMETER	TOT. LENGTH	SHANK DIAMETER	SHANK LENGTH	USEFUL LENGTH	ACTUAL TEETH	BODY	CODICE / SKU	CODICE / SKU	
5	58	10	25	27	2	Acciaio / Steel	PFO7524001	PFO7524002	
6	58	10	25	27	2	Acciaio / Steel	PFO7524003	PFO7524004	
7	58	10	25	27	3	Acciaio / Steel	PFO7524005	PFO7524006	
8	58	10	25	27	2	Acciaio / Steel	PFO7524007	PFO7524008	
10	58	10	25	27	2	Acciaio / Steel	PFO7524009	PFO7524010	

PFO7525		DIMENSIONI DIMENSIONS				ARTICOLI ITEMS		PREZZI €	
D	LT	DS	LS	LU	Z EFF	CORPO	SX / LH	DX / RH	PRICE €
DIAMETER	TOT. LENGTH	SHANK DIAMETER	SHANK LENGTH	USEFUL LENGTH	ACTUAL TEETH	BODY	CODICE / SKU	CODICE / SKU	
5	70	10	25	35	2	Acciaio / Steel	PFO7525001	PFO7525002	
6	70	10	25	35	2	Acciaio / Steel	PFO7525003	PFO7525004	
7	70	10	25	35	3	Acciaio / Steel	PFO7525005	PFO7525006	
8	70	10	25	35	2	Acciaio / Steel	PFO7525007	PFO7525008	
10	70	10	25	35	2	Acciaio / Steel	PFO7525009	PFO7525010	

TLINE 2LH PFO7526 - PFO7527

PUNTA FORATRICE IN HW A LANCIA
CON DOPPIO SMUSSO E CORPO IN ACCIAIO

HW THROUGH HOLES DRILLING BIT
WITH SPECIAL SHARPENING

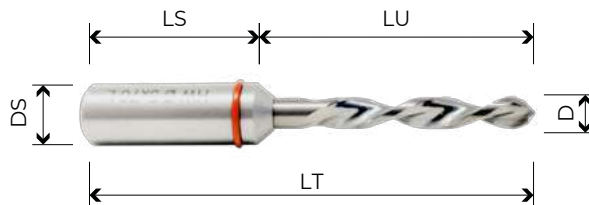

Attacco in acciaio speciale ad alta resistenza. Corpo elicoidale in metallo duro super micrograno di qualità superiore. Punta di centraggio, 2 taglienti (Z2), 2+2 gole elicoidali, 2 incisori ad affilatura rinforzata (V2). Attacco con piano di fissaggio e vite per regolazione assiale.

Premium quality super-strLENGTH steel. HWM spiral portion with centre point. 2 cutting edges (Z2), 2 spiral flutes, 2 curved, negatively ground spurs (V2), Parallel shank with driving flat and adjustable screw LENGTH. Parallel shank with driving flat and adjustable screw LENGTH.



PFO7526		DIMENSIONI DIMENSIONS				ARTICOLI ITEMS		PREZZI €	
D	LT	DS	LS	LU	Z EFF	CORPO	SX / LH	DX / RH	PRICE €
DIAMETER	TOT. LENGTH	SHANK DIAMETER	SHANK LENGTH	USEFUL LENGTH	ACTUAL TEETH	BODY	CODICE / SKU	CODICE / SKU	
3	58	10	25	27	2	Acciaio / Steel	PFO7526001	PFO7526002	
4	58	10	25	27	2	Acciaio / Steel	PFO7526003	PFO7526004	
5	58	10	25	27	3	Acciaio / Steel	PFO7526005	PFO7526006	
6	58	10	25	27	2	Acciaio / Steel	PFO7526007	PFO7526008	
8	58	10	25	27	2	Acciaio / Steel	PFO7526009	PFO7526010	

PFO7527		DIMENSIONI DIMENSIONS				ARTICOLI ITEMS		PREZZI €	
D	LT	DS	LS	LU	Z EFF	CORPO	SX / LH	DX / RH	PRICE €
DIAMETER	TOT. LENGTH	SHANK DIAMETER	SHANK LENGTH	USEFUL LENGTH	ACTUAL TEETH	BODY	CODICE / SKU	CODICE / SKU	
3	70	10	30	35	2	Acciaio / Steel	PFO7527001	PFO7527002	
4	70	10	30	35	2	Acciaio / Steel	PFO7527003	PFO7527004	
5	70	10	30	35	3	Acciaio / Steel	PFO7527005	PFO7527006	
6	70	10	30	35	2	Acciaio / Steel	PFO7527007	PFO7527008	
8	70	10	30	35	2	Acciaio / Steel	PFO7527009	PFO7527010	

SVP SVASATORE PIANE PFO7532 - PFO7533

PUNTA FORATRICE COMPONIBILE IN HW PIANA
CON SVASATORE FISSO

SOLID CARBIDE DOWEL DRILL WITH COUNTERSINK

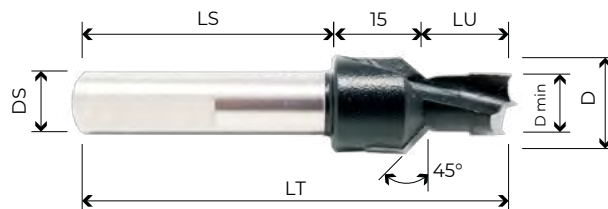

Realizzate con acciaio speciale ad alta resistenza. Rivestimento in resina fluorocarbonica P.T.F.E di colore nero e arancio. Cuspide in HWM, Punta di centraggio, 2 taglienti (Z2), 2 incisori ad affilatura negativa (V2), 2 gole elicoidali. Attacco con piano di fissaggio e vite per regolazione assiale.

Super-strLENGTH steel. Spiral portion coated with orange or black P.T.F.E., HW head with precision balanced centre point, 2 precision ground cutting edges (Z2), 2 ground spurs (V2), 2 spiral flutes. Parallel shank with driving flat and LENGTH adjusting screw.



PFO7532		DIMENSIONI DIMENSIONS				ARTICOLI ITEMS		PREZZI €	
D MIN DIAMETER	LT TOT. LENGTH	DS SHANK DIAMETER	D DIAMETER	LU USEFUL LENGHT	Z EFF ACTUAL TEETH	CORPO BODY	SX / LH CODICE / SKU	DX / RH CODICE / SKU	PRICE €
8	57,5	10	16	12	2+2	ACCAIO	PFO7532021	PFO7532022	
8	57,5	10	16	13	2+2	ACCAIO	PFO7532023	PFO7532024	
8	57,5	10	16	15	2+2	ACCAIO	PFO7532025	PFO7532026	
8	57,5	10	16	18	2+2	ACCAIO	PFO7532027	PFO7532028	
8	57,5	10	16	20	2+2	ACCAIO	PFO7532029	PFO7532030	
10	57,5	10	16	12	2+2	ACCAIO	PFO7532031	PFO7532032	
10	57,5	10	16	13	2+2	ACCAIO	PFO7532033	PFO7532034	
10	57,5	10	16	15	2+2	ACCAIO	PFO7532035	PFO7532036	
10	57,5	10	16	18	2+2	ACCAIO	PFO7532037	PFO7532038	
10	57,5	10	16	20	2+2	ACCAIO	PFO7532039	PFO7532040	

PFO7533		DIMENSIONI DIMENSIONS				ARTICOLI ITEMS		PREZZI €	
D MIN DIAMETER	LT TOT. LENGTH	DS SHANK DIAMETER	D DIAMETER	LU USEFUL LENGHT	Z EFF ACTUAL TEETH	CORPO BODY	SX / LH CODICE / SKU	DX / RH CODICE / SKU	PRICE €
8	70	10	16	12	2+2	ACCAIO	PFO7533017	PFO7533018	
8	70	10	16	13	2+2	ACCAIO	PFO7533019	PFO7533020	
8	70	10	16	15	2+2	ACCAIO	PFO7533021	PFO7533022	
8	70	10	16	20	2+2	ACCAIO	PFO7533023	PFO7533024	
10	70	10	16	12	2+2	ACCAIO	PFO7533025	PFO7533026	
10	70	10	16	13	2+2	ACCAIO	PFO7533027	PFO7533028	
10	70	10	16	15	2+2	ACCAIO	PFO7533029	PFO7533030	
10	70	10	16	20	2+2	ACCAIO	PFO7533031	PFO7533032	

SLV PF07534

PUNTA FORATRICE componibile in HW a lancia per fori passanti con corpo in acciaio

SOLID CARBIDE THROUGH HOLES DOWEL DRILL WITH COUNTERSINK

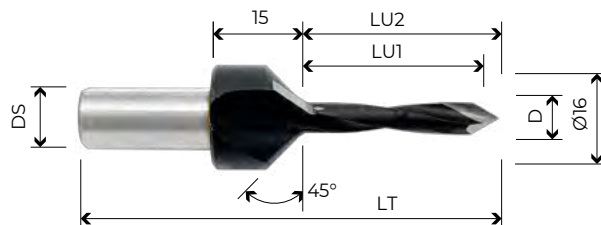

Realizzate con acciaio speciale ad alta resistenza. Rivestimento in resina fluorocarbonica P.T.F.E. nero e arancio. Cuspide in HWM, 2 taglienti (Z2), 4 gole elicoidali. Attacco con piano di fissaggio e vite per regolazioni assiale.

Super-strLENGTH steel. Spiral portion coated with orange or black P.T.F.E., HW head with precision balanced centre point. 2 precision ground cutting edges (Z2), 4 spiral flutes. Parallel shank with driving flat and LENGTH adjusting screw.



DIMENSIONI		DIMENSIONS		ARTICOLI		ITEMS		PREZZI €	
D	LT	DS	LU1	LU2	Z EFF	CORPO	SX / LH	DX / RH	PRICE €
DIAMETER	TOT. LENGTH	SHANK DIAMETER	SHANK LENGTH	USEFUL LENGTH	ACTUAL TEETH	BODY	CODICE / SKU	CODICE / SKU	
5	70	10	31	35	2+2	Acciaio / Steel	PFO7534001	PFO7534002	
7	70	10	29,5	35	2+2	Acciaio / Steel	PFO7534003	PFO7534004	
8	70	10	29	35	2+2	Acciaio / Steel	PFO7534005	PFO7534006	
10	70	10	25	35	2+2	Acciaio / Steel	PFO7534007	PFO7534008	

PFO7528

PUNTA FORATRICE IN HW PER FORI PASSANTI
SOLID CARBIDE DRILLING BIT FOR THROUGH HOLES

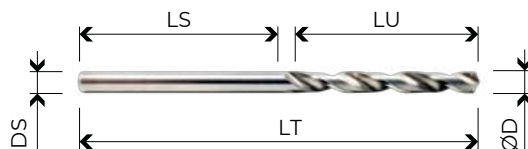

Micrograna di carburo integrale di alta qualità. 2 taglienti (Z2), 2 gole elicoidali. Attacco uguale al diametro di taglio (S=D).

Premium quality HWM. 2 precision ground cutting edges (Z2), 2 spiral flutes. Common shank and drilling diameter (S=D).



DIMENSIONI DIMENSIONS						ARTICOLI ITEMS	PREZZI €	
D	LT	DS	LS	LU	Z EFF	CORPO	CODICE	PRICE €
DIAMETER	TOT. LENGTH	SHANK DIAMETER	SHANK LENGTH	USEFUL LENGTH	ACTUAL TEETH	BODY	SKU	
2	49	2	33	16	2	HW	PFO7528002	
2,5	55	2,5	28	27	2	HW	PFO7528004	
3	55	3	28	27	2	HW	PFO7528006	
3,2	55	3,2	28	27	2	HW	PFO7528008	
3,5	55	3,5	28	27	2	HW	PFO7528010	
4	55	4	28	27	2	HW	PFO7528012	
4,5	55	4,5	28	27	2	HW	PFO7528014	
5	55	5	28	27	2	HW	PFO7528016	

PFO7529

PUNTA FORATRICE IN HW PER FORI CIECHI
SOLID CARBIDE DRILLING BIT FOR BLIND HOLES

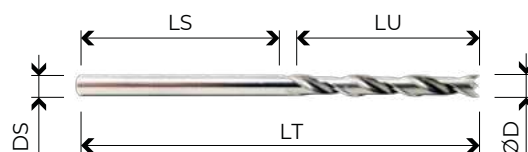

Micrograna di carburo integrale di alta qualità. 2 taglienti (Z2), 2 gole elicoidali. Attacco uguale al diametro di taglio (S=D).

Premium quality HWM. 2 precision ground cutting edges (Z2), 2 spiral flutes. Common shank and drilling diameter (S=D).



DIMENSIONI DIMENSIONS						ARTICOLI ITEMS	PREZZI €	
D	LT	DS	LS	LU	Z EFF	CORPO	CODICE	PRICE €
DIAMETER	TOT. LENGTH	SHANK DIAMETER	SHANK LENGTH	USEFUL LENGTH	ACTUAL TEETH	BODY	SKU	
2	49	2	33	16	2	HW	PFO7529002	
2,5	55	2,5	28	27	2	HW	PFO7529004	
3	55	3	28	27	2	HW	PFO7529006	
3,2	55	3,2	28	27	2	HW	PFO7529008	
3,5	55	3,5	28	27	2	HW	PFO7529010	
4	55	4	28	27	2	HW	PFO7529012	
4,5	55	4,5	28	27	2	HW	PFO7529014	
5	55	5	28	27	2	HW	PFO7529016	

PF07530

SVASATORE COMPONIBILE PER PUNTE FORATRICI
IN HW MOD FLINE

COUNTER SINK FOR DOWEL DRILLS MOD FLINE

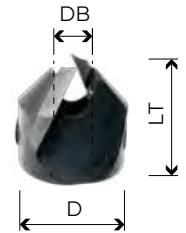

Realizzati con acciaio speciale ad alta resistenza. 2 taglienti HW (Z2), estrema efficacia di fissaggio dello svasatore nell'attacco della punta mediante una vite con estremità a coppa.

Super-strLENGTH steel. 2 precision ground carbide tipped cutting edges (Z2). Direct clamp on the shank of the drills.



DIMENSIONI		DIMENSIONS		ARTICOLI			ITEMS		PREZZI €
DB	D	LT	Z EFF	CORPO	SX / LH	DX / RH	PRICE €		
DIAMETER	DIAMETER	TOT. LENGTH	ACTUAL TEETH	BODY	CODICE / SKU	CODICE / SKU			
4	14	12	2	Acciaio / Steel	PFO7530001	PFO7530002			
5	14	12	2	Acciaio / Steel	PFO7530003	PFO7530004			
6	16	14	2	Acciaio / Steel	PFO7530005	PFO7530006			
6,35	16	14	2	Acciaio / Steel	PFO7530007	PFO7530008			
7	16	14	2	Acciaio / Steel	PFO7530009	PFO7530010			
8	16	16	2	Acciaio / Steel	PFO7530011	PFO7530012			
9	18	16	2	Acciaio / Steel	PFO7530013	PFO7530014			
9,5	20	16	2	Acciaio / Steel	PFO7530015	PFO7530016			
10	20	16	2	Acciaio / Steel	PFO7530017	PFO7530018			
11	20	16	2	Acciaio / Steel	PFO7530019	PFO7530020			
12	20	16	2	Acciaio / Steel	PFO7530021	PFO7530022			

PF07531

SVASATORE COMPONIBILE PER PUNTE FORATRICI
IN HW MOD TLINE

COUNTER SINK FOR DOWEL DRILLS MOD TLINE



Realizzati con acciaio speciale ad alta resistenza. 2 taglienti HW (Z2), estrema efficacia di fissaggio dello svasatore nell'attacco della punta mediante una vite con estremità a coppa.

Super-strLENGTH steel. 2 precision ground carbide tipped cutting edges (Z2). Direct clamp on the shank of the drills.



DIMENSIONI		DIMENSIONS		ARTICOLI			ITEMS		PREZZI €
DB	D	LT	COMPATIBILE PER PUNTE	Z EFF	CORPO	SX / LH	DX / RH	PRICE €	
DIAMETER	DIAMETER	TOT. LENGTH	D 4-10	ACTUAL TEETH	BODY	CODICE / SKU	CODICE / SKU		
10	20	15	DA D 4 A D10	2	Acciaio / Steel	PFO7531001	PFO7531002		
10	22	16	DA D11 A D12	2	Acciaio / Steel	PFO7531003	PFO7531004		



ATTACCHI E MANDRINI

TOOL HOLDERS AND SLEEVES

ATTACCHI E MANDRINI

TOOLS HOLDERS AND SLEEVES



AEM8020

GHIERA TURBOFUN CON TURBINA DI ESTRAZIONE TRUCIOLI
TURBOFUN RING WITH CHIPBOARD EXTRACTION FAN

200
PAG.



AEM8005

MANDRINI PORTAFRESE
ATTACCO HSK63F HI=33 MM
TOOL HOLDER
HSK63F HI=33 MM

204
PAG.



AEM8043

MANDRINO IDRAULICO
HSK63F MICROHYDRO
HYDRAULIC TOOL HOLDER
HSK63F MICROHYDRO

201
PAG.



AEM8006

MANDRINI PORTAFRESE
ATTACCO HSK63F HI=42
TOOL HOLDER HSK63F HI=42

204
PAG.



AEM8001

MANDRINO
PORTAPINZA HSK63F
TOOL HOLDER HSK63F

201
PAG.



AEM8044

FLANGIA PER LAME
FLANGE FOR SAW BLADES

204
PAG.



AEM8037

MANDRINO PORTAPINZA
HSK63F INOX
TOOL HOLDER HSK63F INOX

201
PAG.



AEM8038

MANDRINO PORTALAMA
CON ATTACCO HSK63F
TOOL HOLDER HSK63F
FOR SAW BLADE

205
PAG.



AEM8002

MANDRINO
PORTAPINZA ISO30
TOOL HOLDER ISO30

202
PAG.



AEM8033

ALBERO PORTALAMA
CON ATTACCO CILINDRICO
SAWBLADE TOOL HOLDER
WITH SHANK

205
PAG.



AEM8003

MANDRINO PORTAPINZA
ISO30 - MORBIDELLI, SCM
TOOL HOLDER ISO30
MORBIDELLI AND SCM

202
PAG.



AEM8042

MANDRINO PORTALAMA
CON ATTACCO HSK63F
CON FLANGIA MODELLO BIESSE
TOOL HOLDER FOR SAWBLADE
WITH HSK63F ATTACHMENT
WITH FLANGE "BIESSE TYPE"

206
PAG.



AEM8004

MANDRINO
PORTAPINZA HSK50F
TOOL HOLDER HSK50F

202
PAG.



AEM8030

SMONTACONI UNIVERSALE
PER MANDRINI HSK63F - ISO30
UNIVERSAL ASSEMBLY
SUPPORTS FOR CHUCKS
HSK63F - ISO30

206
PAG.



AEM8039

MANDRINO PORTAPINZA
HSK63F
TOOL HOLDER HSK63F

203
PAG.



AEM8048

PINZE PER MANDRINI
HYDRO ULTRAPRECISE
HIGH PRECISION COLLET
FOR HYDRO TOOL HOLDER

NEW
206
PAG.



AEM8046

MANDRINO PORTAPINZA
HSK63F FORO 10 + GRANO
PER FORATRICI SU CNC
HSK63F CHUCK, HOLE 10 + GRAIN
FOR DRILLING ON CNC MACHINE

NEW
203
PAG.



AEM8007

PINZE ELASTICHE ER11
COLLET ER11

207
PAG.



AEM8032

MANDRINO THERMO GRIP
THERMO GRIP TOOL HOLDER

203
PAG.



AEM8008

PINZE ELASTICHE ER16
COLLET ER16

207
PAG.



AEM8040

MANDRINO
THERMO GRIP ISO30
THERMO GRIP TOOL
HOLDER ISO30

204
PAG.



AEM8009

PINZE ELASTICHE ER20
COLLET ER20

207
PAG.

ATTACCHI E MANDRINI

TOOLS HOLDERS AND SLEEVES



AEM8010
PINZE ELASTICHE ER25
COLLET ER25

207
PAG.



AEM8019
GHIERA PER MANDRINO HSK ER40 CON CUSCINETTI A SFERA
CLAMPING NUTS HSK ER40 WITH BEARING

209
PAG.



AEM8011
PINZE ELASTICHE ER32
COLLET ER32

207
PAG.



AEM8023
CODOLI DI AGGANCIAMENTO PERMACCHINA ALBERTI SENZA FORO
RETAINING STUDS FOR CHUCKS, WITHOUT HOLE. MACHINES: ALBERTI

210
PAG.



AEM8012
PINZE ELASTICHE ER32 ALTA PRECISIONE 0,005 MM
COLLET ER32 HIGH PRECISION 0,005 MM

208
PAG.



AEM8024
CODOLI DI AGGANCIAMENTO PER MACCHINA BIESSE SENZA FORO
RETAINING STUDS FOR CHUCKS, WITHOUT HOLE. MACHINES: BIESSE

210
PAG.



AEM8013
PINZE ELASTICHE ER40
COLLET ER40

208
PAG.



AEM8025
CODOLI DI AGGANCIAMENTO PER MACCHINA CMS SENZA FORO
RETAINING STUDS FOR CHUCKS, WITHOUT HOLE. MACHINES: CMS

210
PAG.



AEM8014
PINZE ELASTICHE ER40 ALTA PRECISIONE 0,005 MM
COLLET ER40 HIGH PRECISION 0,005 MM

208
PAG.



AEM8026
CODOLI DI AGGANCIAMENTO PER MACCHINA SCM SENZA FORO
RETAINING STUDS FOR CHUCKS, WITHOUT HOLE. MACHINES: SCM

210
PAG.



AEM8015
PINZE ELASTICHE EOC25
COLLET EOC25

208
PAG.



AEM8027
CODOLI DI AGGANCIAMENTO DIN 69872 MASTERWOOD E CMS SENZA FORO
RETAINING STUDS FOR CHUCKS DIN 69872, WITHOUT HOLE. MACHINES: MASTERWOOD E CMS

210
PAG.



AEM8041
MOZZO MECCANICO PER TRUCIOLATORI E FRESE
MECHANICAL SLEEVE FOR HOGGERS AND CUTTERS D200/250

209
PAG.



AEM8021
FLANGIA DI RICAMBIO MASCHIO PER MANDRINI ALBERATI
STEEL FLANGE FOR CHUCKS WITH ARBOR - MALE

211
PAG.



AEM8047
MOZZO MECCANICO CON GHIERA DI CHIUSURA PER GRUPPI FRESE
MECHANICAL SLEEVE WITH CLOSING NUT FOR MILLING GROUPS

NEW
209
PAG.



AEM8022
FLANGIA DI RICAMBIO FEMMINA PER MANDRINI ALBERATI
STEEL FLANGE FOR CHUCKS WITH ARBOR - FEMALE

211
PAG.



AEM8016
GHIERA PER MANDRINO HSK ER32
CLAMPING NUTS HSK ER32

209
PAG.



AEM8028
CHIAVI PER GHIERE ER DIN6499 STANDARD
C-SPANNER FOR CLAMPING NUTS ER DIN6499 STANDARD

211
PAG.



AEM8017
GHIERA PER MANDRINO HSK ER32 CON CUSCINETTI A SFERA
CLAMPING NUTS HSK ER32 WITH BEARING

209
PAG.



AEM8029
CHIAVI PER GHIERE A SETTORE ER DIN6388 STANDARD
C-SPANNER FOR CLAMPING NUTS ER DIN6388 STANDARD

211
PAG.



AEM8018
GHIERA PER MANDRINO HSK ER40
CLAMPING NUTS HSK ER40

209
PAG.

AEM8020

GHIERA TURBOFUN CON TURBINA DI ESTRAZIONE TRUCIOLI TURBOFUN RING WITH CHIPBOARD EXTRACTION FAN

Ghiera con turbina di estrazione del truciolo applicabile sui mandrini HSKER32 HSKER40 EOC25 (DIN6388) e HYDRO ETP. La turbina sostituisce la ghiera standard o viene applicata esternamente al mandrino HYDRO ETP. Massima estrazione del truciolo sul piano lavorato. Raccomandato per operazioni di nesting con piano martire dove il truciolo non puo' evacuare nella parte bassa del pannello. L'estrazione del truciolo permette un aumento di durate e finitura dell'utensile. Il corpo in lega della turbina è rivestito per aumentare la durezza e all'interno è stata applicata una ghiera in acciaio. Possibilità di utilizzo dai 10000 rpm fino ai 20000 rpm. Materiali lavorabili: truciolare, MDF, corian, OSB, multistrato, materiali plastici. Accorgimenti: utilizzare la turbina il piu' possibile vicino al pannello (1 mm min - 3 mm max) garantendo una maggiore pressione di estrazione del truciolo. Per il serrare o allentare la turbina di aspirazione e' necessaria una standard chiave a I per ghiera ER40, non e' richiesta una chiave specifica.

Collet nut with chip extraction turbine applicable on tools holders HSKER32 HSKER40 EOC25 (DIN6388) and HYDRO ETP. The turbine replaces the standard collet nut or is externally applied to the HYDRO ETP spindle. Maximum extraction of the chip on the worked surface. Recommended for nesting operations with sacrificed panel where the chips cannot evacuate in the low part of the panel. The extraction of the chip allows an increase in durability and finishing of the tool. The alloy body of the turbine is coated to increase hardness and a steel ring is fitted inside. Possibility to use it from 10000 rpm up to 20000 rpm. Workable materials: chipboard, mdf, corian, osb, multilayer, plastic materials. Note: Use the turbine as possible as near the panel (1 mm min - 3 mm max) guaranteeing a vacuum and therefore a better evacuation of the chip. To block and unlock the turbine no special key is required a standard key for ER40 is required.

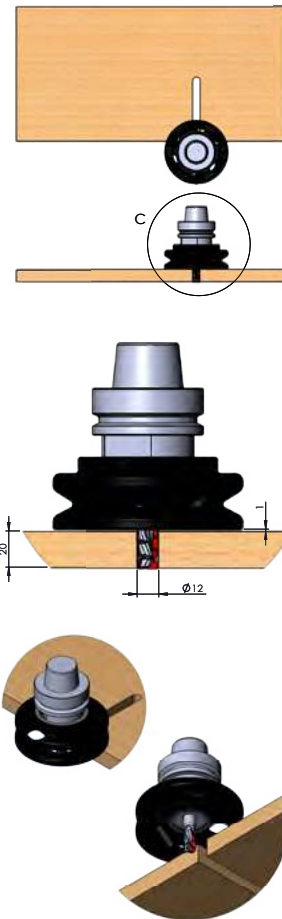

DIMENSIONI		DIMENSIONS		ARTICOLI	ITEMS	PREZZI €
D	B	GHIERA	TIPO	CODICE / SKU		PRICE €
DIAMETER	THICKNESS	RING	TYPE			
105	40	ER32		AEM8020001		
105	40	ER40		AEM8020002		
105	40	EOC25		AEM8020003		
100	40		HYDRO ETP D12	AEM8020004		
100	40		HYDRO ETP D16 / D20	AEM8020005		

GHIERA IN ACCIAIO INTERNA PER EVITARE QUALSIASI FORMA DI FRIZIONAMENTO E USURA CON IL MANDRINO PORTAPINZA.

SIDE STEEL RING NUT TO AVOID ANY KIND OF CLUTCHING AND WEARING WITH THE TOOL HOLDER.

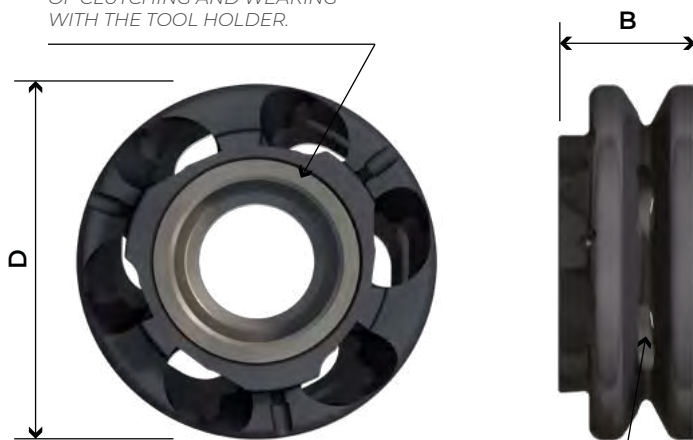

APERTURE LATERALI PER AUMENTARE LA DEPRESSIONE E ALLEGGERIRE LA TURBINA.
SIDE OPENINGS TO INCREASE THE VACUUM AND LIGHTEN THE TURBINE.

TURBINA IN ALLUMINIO (CON RIVESTIMENTO ESTERNO ANTI-USURA) CALETTATA E FISSATA CON GRANI ALLA GHIERA IN ACCIAIO INTERNA.

TURBINE IN ALUMINUM (WITH EXTERNAL ANTI-WEAR COATING) FIXED WITH GRAINS TO THE INSIDE STEEL RING.

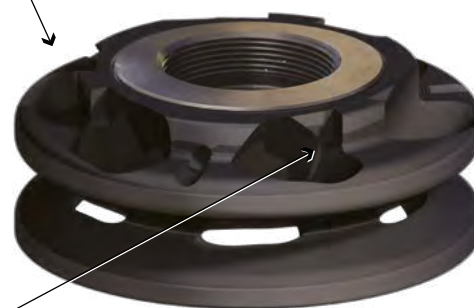

FESSURE PER CHIAVI DI SERRAGGIO STANDARD PER HSK63 ER40 A SETTORE DIN6388 CODICE AEM8029002. (LA CHIAVE SPECIALE DI APERTURA E SERRAGGIO DELLA TURBINA NON E' PIU' NECESSARIA).

SLOTS FOR STANDARD TIGHTENING KEYS FOR HSK63 ER40 IN SECTOR DIN6388 CODE AEM8029002 (THE TURBINE OPENING AND TIGHTENING KEY IS NO LONGER NECESSARY).

AEM8043

MANDRINO IDRAULICO HSK63F MICROHYDRO HYDRAULIC TOOL HOLDER HSK63F MICROHYDRO

Mandrino HSK63F ad alta precisione e forza di serraggio con tolleranza albero/foro +/- 0,006. Il gambo dell'utensile in ingresso deve essere con tolleranza h6. Non stringere la vite di serraggio se non e' presente l'utensile al suo interno. Pulire bene il gambo dell'utensile e il foro del mandrino prima di inserire la fresa.

HYDRO HSK63F spindle with shaft/bore tolerance +/- 0.006. HSK63F high precision spindle and clamping force. The TOOL shank must be with tolerance H6. Do not tighten the clamping screw if there is no tool inside. Clean the tool shank and the spindle hole thoroughly before inserting the cutter.

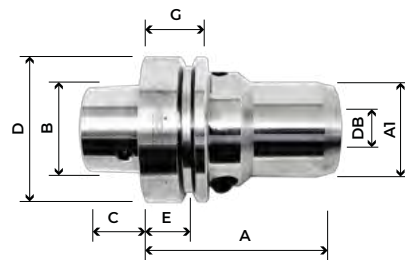

PORTA UTENSILE TOOL HOLDER		DB HOLE DIAMETER	ROTAZIONE ROTATION	DIMENSIONI DIMENSIONS							ARTICOLI ITEMS		PREZZI €
D	A	AI	B	C	E	G	CODICE / SKU		PRICE €				
HSK63F	10	DX/SX	63	80	31,5	38	25	18	26	AEM8043005	NEW		
HSK63F	12	DX/SX	63	80	31,5	38	25	18	26	AEM8043001			
HSK63F	16	DX/SX	63	80	37,6	38	25	18	26	AEM8043003			
HSK63F	20	DX/SX	63	80	41,5	38	25	18	26	AEM8043002			
HSK63F	25	DX/SX	63	80	53	38	25	18	26	AEM8043004			

AEM8001

MANDRINO PORTAPINZA HSK63F TOOL HOLDER HSK63F

Mandrini portapinze HSK63F con errore di concentricità massimo tra cono e sede utensile di 0,003 mm.

Tool holder HSK63F with tolerance between the tool holder and tool house 0,003 mm.

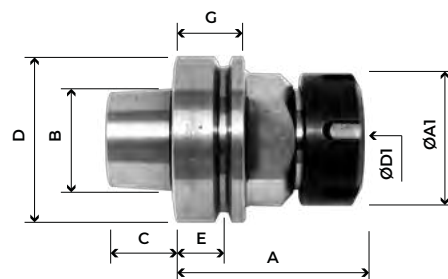

PORTA UTENSILE TOOL HOLDER		PINZA COLLET	ROTAZIONE ROTATION	D	A	DI CLAMPING RANGE	TIPOLOGIA GHIERA CLAMPING NUTS	A1	B	C	E	G	ARTICOLI ITEMS		PREZZI €
CODICE / SKU		PRICE €													
HSK63F	ER32	DX	63	73	3-20	ER32	50	38	25	18	26	AEM8001001			
HSK63F	ER32	SX	63	73	3-20	ER32	50	38	25	18	26	AEM8001002			
HSK63F	ER40	DX	63	78	4-30	ER40	63	38	25	18	26	AEM8001003			
HSK63F	ER40	SX	63	78	4-30	ER40	63	38	25	18	26	AEM8001004			
HSK63F	ER32	DX	63	73	3-20	ER32 CUSCINETTO	50	38	25	18	26	AEM8001005			
HSK63F	ER40	DX	63	78	4-30	ER40 CUSCINETTO	63	38	25	18	26	AEM8001006			
HSK63F	ER32	SX	63	73	3-20	ER32 CUSCINETTO	50	38	25	18	26	AEM8001007			
HSK63F	ER40	SX	63	78	4-30	ER40 CUSCINETTO	63	38	25	18	26	AEM8001008			

AEM8037

MANDRINO PORTAPINZA HSK63F - INOX TOOL HOLDER HSK63F - INOX

Mandrini portapinze HSK63F INOX con errore di concentricità massimo tra cono e sede utensile di 0,003 mm resistente all'ossidazione.

Tool holder HSK63F INOX with tolerance between the tool holder and tool house 0,003 mm. Oxidation resistance.

NO OSSIDAZIONE
NO OXIDATION

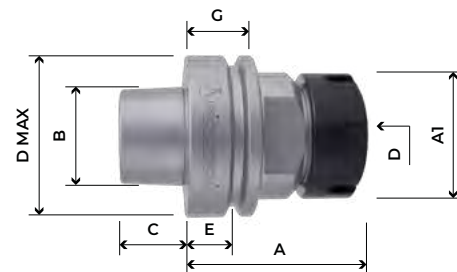

TIP. CONO TOOL HOLDER		PINZA COLLET	ROTAZIONE ROTATION	D	A	DI CLAMPING RANGE	TIPOLOGIA GHIERA CLAMPING NUTS	A1	B	C	E	G	ARTICOLI ITEMS		PREZZI €
CODICE / SKU		PRICE €													
HSK63F	ER32	DX	63	68	3-20	ER32	50	38	25	18	26	AEM8037001			
HSK63F	ER32	SX	63	68	3-20	ER32	50	38	25	18	26	AEM8037002			
HSK63F	ER40	DX	63	72	4-30	ER40	63	38	25	18	26	AEM8037003			
HSK63F	ER40	SX	63	72	4-30	ER40	63	38	25	18	26	AEM8037004			
HSK63F	ER32	DX	63	68	3-20	ER32 CUSCINETTO	50	38	25	18	26	AEM8037005			
HSK63F	ER40	DX	63	72	4-30	ER40 CUSCINETTO	63	38	25	18	26	AEM8037006			
HSK63F	ER32	SX	63	68	3-20	ER32 CUSCINETTO	50	38	25	18	26	AEM8037007	NEW		
HSK63F	ER40	SX	63	72	4-30	ER40 CUSCINETTO	63	38	25	18	26	AEM8037008	NEW		

AEM8002

MANDRINO PORTAPINZA ISO30

TOOL HOLDER ISO30

Mandrini portapinze ISO30 per macchine Biesse, Omlat engine, Bulleri, Busellato, CMS, IMA, Alberti, Masterwood.

Tool holder ISO 30 to be use on Biesse, Omlat engine, Bulleri, Busellato, CMS, IMA, Alberti, Masterwood machines,

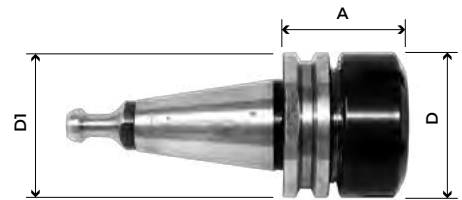

DIMENSIONI DIMENSIONS			MACCHINA			ARTICOLI ITEMS	PREZZI €	
PORTA UTENSILE TOOL HOLDER	PINZA COLLET	ROTAZIONE ROTATION	D1	A	D	MACHINE TYPES	CODICE / SKU	PRICE €
ISO30	ER32	DX	50	50	50	BIESSE	AEM8002001	
ISO30	ER32	SX	50	50	50	BIESSE	AEM8002002	
ISO30	ER32	DX	50	50	50	IMA, CMS, BUSE. BULL., OML. ENG.	AEM8002003	
ISO30	ER32	SX	50	50	50	IMA, CMS, BUSE. BULL., OML. ENG.	AEM8002004	
ISO30	ER32	DX	50	50	50	ALBERTI, MASTERW.	AEM8002005	
ISO30	ER32	SX	50	50	50	ALBERTI, MASTERWOOD	AEM8002006	
ISO30	ER32	DX	50	67	50	BIESSE	AEM8002015	
ISO30	ER32	SX	50	67	50	BIESSE	AEM8002016	
ISO30	ER32	DX	50	67	50	IMA, CMS, BUSE. BULL., OML. ENG.	AEM8002017	
ISO30	ER32	SX	50	67	50	IMA, CMS, BUSE. BULL., OML. ENG.	AEM8002018	
ISO30	ER32	DX	50	67	50	ALBERTI, MASTERW.	AEM8002019	
ISO30	ER32	SX	50	67	50	ALBERTI, MASTERW.	AEM8002020	
ISO30	ER40	DX	50	57	63	BIESSE	AEM8002007	
ISO30	ER40	SX	50	57	63	BIESSE	AEM8002008	
ISO30	ER40	DX	50	57	63	IMA, CMS, BUSE. BULL., OML. ENG.	AEM8002009	
ISO30	ER40	SX	50	57	63	IMA, CMS, BUSE. BULL., OML. ENG.	AEM8002010	
ISO30	ER40	DX	50	57	63	ALBERTI, MASTERW.	AEM8002011	
ISO30	ER40	SX	50	57	63	ALBERTI, MASTERW.	AEM8002012	
ISO30	ER32	DX	50	67	50	MASTERWOOD, CMS	AEM8002014	

AEM8003

MANDRINO PORTAPINZA ISO30 - MACCHINA MORBIDELLI, SCM

TOOL HOLDER ISO30 - MORBIDELLI AND SCM MACHINES

Mandrini portapinze ISO30 per macchine Morbidelli e SCM.

Tool holder ISO 30 to be use on Morbidelli and SCM machines.

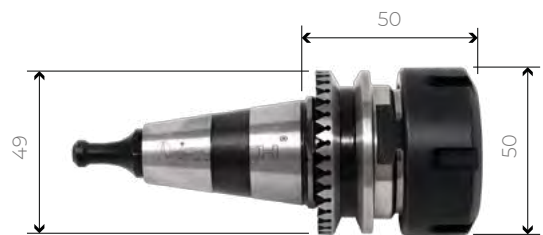

DIMENSIONI DIMENSIONS			MACCHINA			ARTICOLI ITEMS	PREZZI €
PORTA UTENSILE TOOL HOLDER	PINZA COLLET	ROTAZIONE ROTATION	MACHINE TYPES			CODICE / SKU	PRICE €
ISO30 FLANGIA DENTATA / TOOTHED FLANGE	ER32	DX	MORBIDELLI, SCM			AEM8003001	
ISO30 FLANGIA DENTATA / TOOTHED FLANGE	ER32	SX	MORBIDELLI, SCM			AEM8003002	
ISO30 FLANGIA DENTATA / TOOTHED FLANGE	ER40	DX	MORBIDELLI, SCM			AEM8003003	
ISO30 FLANGIA DENTATA / TOOTHED FLANGE	ER40	SX	MORBIDELLI, SCM			AEM8003004	

AEM8004

MANDRINO PORTAPINZA HSK50F

TOOL HOLDER HSK50F

Mandrini portapinze HSK50F con errore di concentricità massimo tra cono e sede utensile di 0,003 mm.

Tool holder HSK50F with tollerance between the tool holder and tool house 0,003 mm.

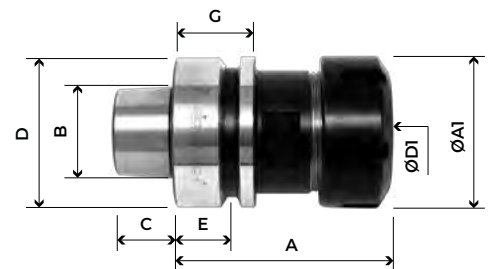

DIMENSIONI DIMENSIONS			MACCHINA								ARTICOLI ITEMS	PREZZI €
PORTA UTENSILE TOOL HOLDER	PINZA COLLET	ROTAZIONE ROTATION	D	A	D1 - CLAMPING RANGE	A1	B	C	E	G	CODICE / SKU	PRICE €
HSK50F	ER32	DX	50	73	3*20	50	30	20	18	26	AEM8004001	
HSK50F	ER32	SX	50	73	3*20	50	30	20	18	26	AEM8004002	
HSK50F	ER40	DX	50	75	4*30	63	30	20	18	26	AEM8004003	
HSK50F	ER40	SX	50	75	4*30	63	30	20	18	26	AEM8004004	

AEM8039

MANDRINO PORTAPINZA HSK63F DIN 6388 CON PINZA EOC TOOL HOLDER HSK63F DIN 6388 FOR COLLET EOC

Per macchine Homag, Eima da 9/94, Dubus, Weeke, Biesse, SCM, Morbidelli, Masterwood. Per bassi sforzi di taglio utilizzabile anche con frese di rotazione sinistra.

Suitable for Homag, Eima from 9/94, Dubus, Weeke, Biesse, SCM, Morbidelli, Masterwood. Nut with bearing for tools with left or right rotation.

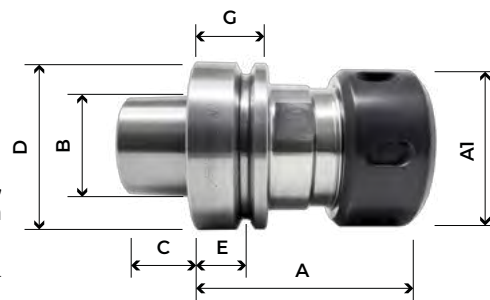

DIMENSIONI DIMENSIONS						ARTICOLI ITEMS		PREZZI €					
TIPOLOGIA CONO TOOL HOLDER	PINZA COLLET	ROTAZIONE ROTATION	D	A	D1 CLAMPING RANGE	TIPOLOGIA GHIERA CLAMPING NUTS	A1	B	C	E	G	CODICE / SKU	PRICE €
HSK63F	EOC25	DX	63	77	3-25	EOC25	60	38	25	18	26	AEM8039001	
HSK63F	EOC25	SX	63	77	3-25	EOC25	60	38	25	18	26	AEM8039002	
HSK63F	EOC25	DX	63	77	3-25	EOC25 CUSCINETTO	60	38	25	18	26	AEM8039003	
HSK63F	EOC25	SX	63	77	3-25	EOC25 CUSCINETTO	60	38	25	18	26	AEM8039004	

AEM8046

MANDRINO PORTAPINZA HSK63F FORO 10 + GRANO PER FORATRICI SU CNC

HSK63F CHUCK, HOLE 10 + GRAIN FOR DRILLING ON CNC MACHINE

Mandrini portapinze HSK63F con errore di concentricità massimo tra cono e sede utensile di 0,003 mm ideale per lavorare su CNC con punte foratrici attacco 10. Il grano laterale permette di bloccare le punte foratrici e di non avere errori di concentricità durante la lavorazione.

HSK63F chuck with a maximum error of concentricity between the cone and the tool seat of 0,003 mm, ideal for working on cnc with drilling bits with shank 10 mm. The side grain gives the possibility to lock the drilling bits and to avoid error of concentricity while working operation.

MANDRINO PER FORATRICI SU CNC
TOOL HOLDER FOR DRILLING ON CNC MACHINE

NEW

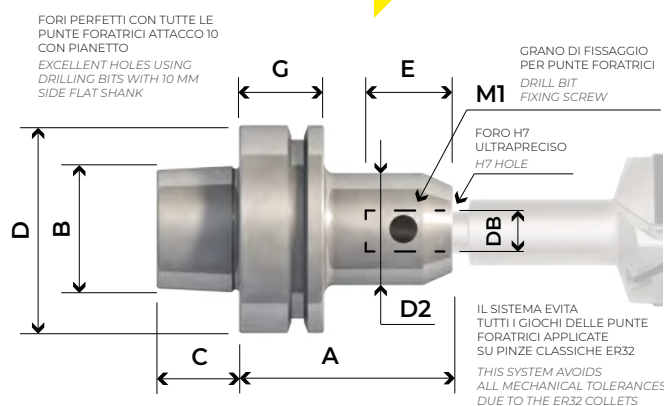

DIMENSIONI DIMENSIONS										ARTICOLI ITEMS		PREZZI €	
TIPOLOGIA CONO TOOL HOLDER	ROTAZIONE ROTATION	D	A	DB CLAMPING RANGE	B	C	E	G	D2	CODICE / SKU	PRICE €		
HSK63F	DX SX	63	65	10	38	25	30	26	34	AEM8046001	NEW		

AEM8032

MANDRINO THERMO GRIP THERMO GRIP TOOL HOLDER

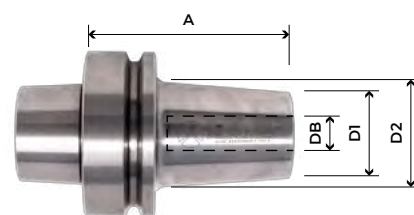

DIMENSIONI DIMENSIONS					ARTICOLI ITEMS		PREZZI €	
TIPOLOGIA CONO TOOL HOLDER	DB HOLE DIAMETER	D1 DIAMETER	D2 DIAMETER	A THICKNESS	TIPO TYPE	CODICE / SKU	PRICE €	
HSK63F	6	22	29	75	HSK63F	AEM8032013		
HSK63F	8	22	29	75	HSK63F	AEM8032011		
HSK63F	10	25	31	75	HSK63F	AEM8032009		
HSK63F	12	28	34	75	HSK63F	AEM8032001		
HSK63F	16	28	34	75	HSK63F	AEM8032002		
HSK63F	20	36	42	75	HSK63F	AEM8032003		
HSK63F	25	36	42	75	HSK63F	AEM8032004		
HSK63F	30	36	42	75	HSK63F	AEM8032014		
HSK63F	8	22	29	95	HSK63F	AEM8032012		
HSK63F	10	25	31	95	HSK63F	AEM8032010		
HSK63F	12	28	34	95	HSK63F	AEM8032005		
HSK63F	16	28	34	95	HSK63F	AEM8032006		
HSK63F	20	36	42	95	HSK63F	AEM8032007		
HSK63F	25	36	42	95	HSK63F	AEM8032008		

AEM8040

MANDRINO THERMO GRIP ISO30

Mandrino Thermo grip ISO30 senza codolo. Per abbinare il codolo relativo alla macchina scegliere tra AEM8023 - AEM8024 - AEM8025 - AEM8026 - AEM8027.

THERMO GRIP TOOL HOLDER ISO30

Thermo TOOL HOLDER grip ISO30 without shank. To match the CORECT shank for the machine, choose between AEM8023 - AEM8024 - AEM8025 - AEM8026 - AEM8027.

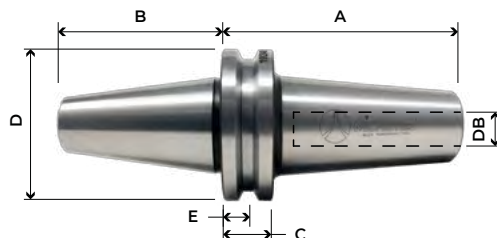

DIMENSIONI DIMENSIONS							ARTICOLI ITEMS	PREZZI €
TIP. CONO TOOL HOLDER	A THICKNESS	B THICKNESS	C THICKNESS	E THICKNESS	DB HOLE DIAMETER	D DIAMETER	CODICE / SKU	PRICE €
ISO30	51	77	8	16	12	50	AEM8040001	
ISO30	51	80	8	16	16	50	AEM8040002	
ISO30	51	77	7,8	16	20	50	AEM8040003	
ISO30	51	97	7,8	16	25	50	AEM8040004	

AEM8005

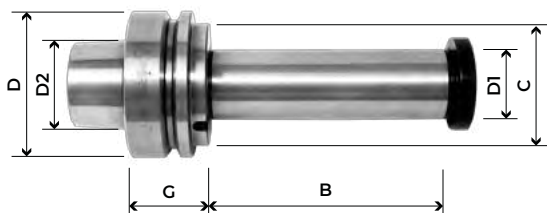

MANDRINI ALBERATO CON ATTACCO HSK63F G=33

Mandrino portafrese di varie altezze con attacco HSK63F alberato.

TOOL HOLDER HSK63F G=33 WITH ARBOR

Tool Holder HSK63F of various heights with arbor different size.

DIMENSIONI DIMENSIONS						ARTICOLI ITEMS	PREZZI €
PORTA UT. TOOL HOLDER	D1 DIAMETER	G DIAMETER	D DIAMETER	B DIAMETER	C DIAMETER	CODICE / SKU	PRICE €
HSK63F	30	33	63	40	45	AEM8005011	
HSK63F	30	33	63	55	45	AEM8005026 NEW	
HSK63F	30	33	63	70	45	AEM8005010	
HSK63F	30	33	63	80	45	AEM8005001	
HSK63F	30	33	63	100	45	AEM8005002	
HSK63F	30	33	63	110	45	AEM8005015	
HSK63F	30	33	63	120	45	AEM8005016	
HSK63F	30	33	63	130	45	AEM8005024	
HSK63F	30	33	63	160	45	AEM8005003	
HSK63F	30	33	63	200	45	AEM8005025	
HSK63F	30	33	63	250	45	AEM8005012	
HSK63F	35	33	63	70	50	AEM8005028	
HSK63F	35	33	63	80	50	AEM8005004	
HSK63F	35	33	63	100	50	AEM8005005	
HSK63F	35	33	63	110	50	AEM8005018	
HSK63F	35	33	63	120	50	AEM8005019	
HSK63F	35	33	63	130	50	AEM8005017	
HSK63F	35	33	63	160	50	AEM8005006	
HSK63F	40	33	63	80	53	AEM8005007	
HSK63F	40	33	63	100	53	AEM8005008	
HSK63F	40	33	63	110	53	AEM8005020	
HSK63F	40	33	63	120	53	AEM8005021	
HSK63F	40	33	63	130	53	AEM8005022	
HSK63F	40	33	63	160	53	AEM8005009	
HSK63F	40	33	63	200	53	AEM8005023	
HSK63F	40	33	63	300	53	AEM8005013	

AEM8006

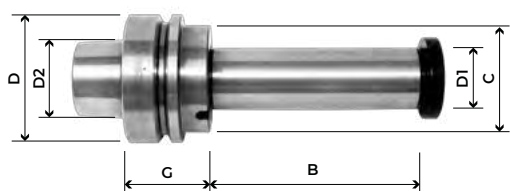

MANDRINI ALBERATO CON ATTACCO HSK63F G=42

Mandrino portafrese di varie altezze con attacco HSK63F alberato.

TOOL HOLDER HSK63F G=42 WITH ARBOR

Tool Holder HSK63F of various heights with arbor different size.

DIMENSIONI DIMENSIONS						ARTICOLI ITEMS	PREZZI €
PORTA UTENSILE TOOL HOLDER	D1 DIAMETER	G DIAMETER	D DIAMETER	B DIAMETER	C DIAMETER	CODICE / SKU	PRICE €
HSK63F	30	42	63	100	45	AEM8006001	
HSK63F	30	42	63	150	45	AEM8006002	
HSK63F	30	42	63	200	45	AEM8006003	
HSK63F	35	42	63	100	50	AEM8006004	
HSK63F	35	42	63	150	50	AEM8006005	
HSK63F	35	42	63	200	50	AEM8006006	

AEM8044 FLANGIA PER LAME FLANGE FOR SAW BLADES

DIMENSIONI DIMENSIONS				ARTICOLI ITEMS	PREZZI €
D DIAMETER	DB HOLE DIAMETER	A THICKNESS	B THICKNESS	CODICE / SKU	PRICE €
90	30	10	9	AEM8044001	

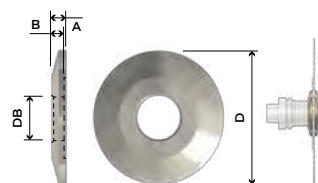

AEM8038

MANDRINO PORTALAMA
CON ATTACCO HSK63F
PER LAME CIRCOLARI
TOOL HOLDER HSK63F
FOR SAW BLADE

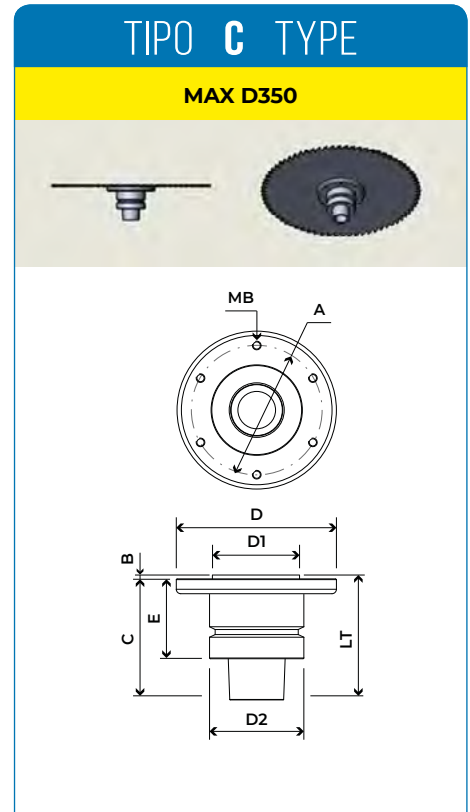
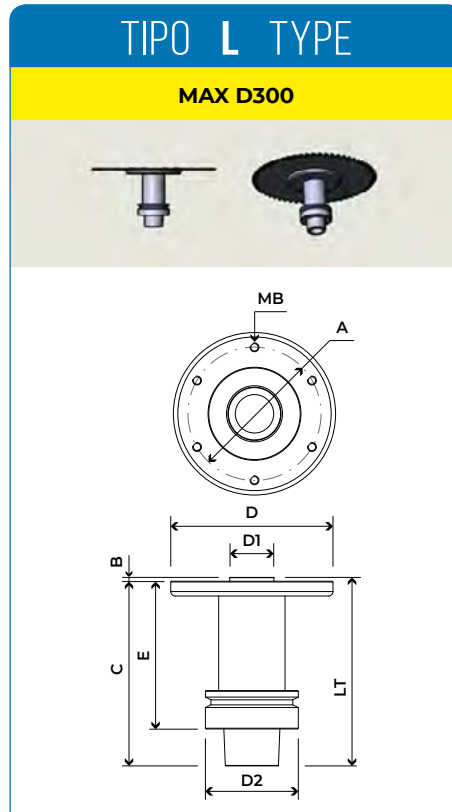

DIMENSIONI DIMENSIONS									ARTICOLI ITEMS	PREZZI €	
D1 DIAMETER	E THICKNESS	D DIAMETER	LT TOTAL LENGTH	C THICKNESS	D2 DIAMETER	A THICKNESS	B THICKNESS	FT / PH PHIN HOLE	TIPO TYPE	CODICE / SKU	PRICE €
30	100	110	127,6	125	63	90	2,6	N6 / M6 / INT90	L	AEM8038001	
30	50	106	77,6	75	63	90	2,6	N8 / M5 / INT90	C	AEM8038002	
30	50	106	77,6	75	63	90	2,6	N6 / M6 / INT90	C	AEM8038003	
30	40	109	67,6	65	63	90	2,6	N6 / M6 / INT90	C	AEM8038004	NEW

AEM8033

ALBERO PORTALAMA CON ATTACCO CILINDRICO
SAWBLADE TOOL HOLDER WITH SHANK

Albero portalama con attacco cilindrico per lamello Clamex F22
e per lame con foro 20/30.

Sawblade tool holder with shank for lamello clemex f22 and
sawblades with hole 20/30.



DIMENSIONI DIMENSIONS										ARTICOLI ITEMS	PREZZI €
DS S. DIAMETER	D1 DIAMETER	LS S. LENGTH	LT TOT. LENGTH	B THICKNESS	FT / PH PHIN HOLE	MA THREAD SIZE	MB THREAD SIZE	A TICKNESS	D DIAMETER	CODICE / SKU	PRICE €
20	20	70	90	2,5	4/M5/35	M6	M5	35	50	AEM8033001	
20	22	70	90	4	4/M4/35,9	M6	M4	35,9	50	AEM8033002	
20	30	70	90	2,5	4/M5/45+4/M6/48	M6	M5/M6	45/48	60	AEM8033003	
16	22	70	90	4	4/M4/35,9	M6	M4	35,9	50	AEM8033004	
20	22	70	125	4	4/M4/35,9	M6	M4	35,9	50	AEM8033005	

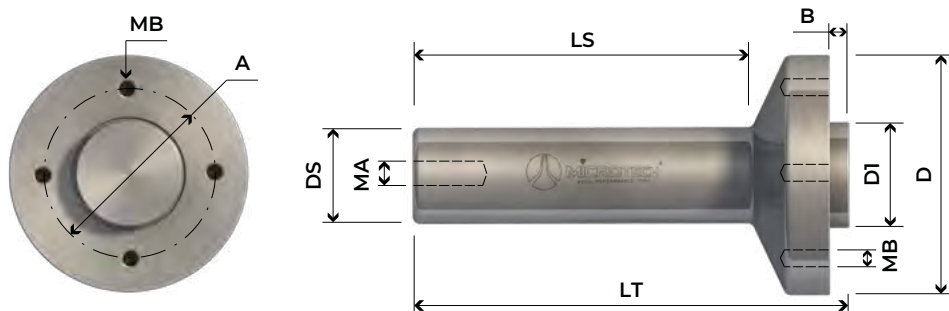

AEM8042

BIESSE

MANDRINO PORTALAMA CON ATTACCO HSK63F
CON FLANGIA MODELLO BIESSE
TOOL HOLDER FOR SAWBLADE WITH HSK63F
ATTACHMENT WITH FLANGE "BIESSE TYPE"

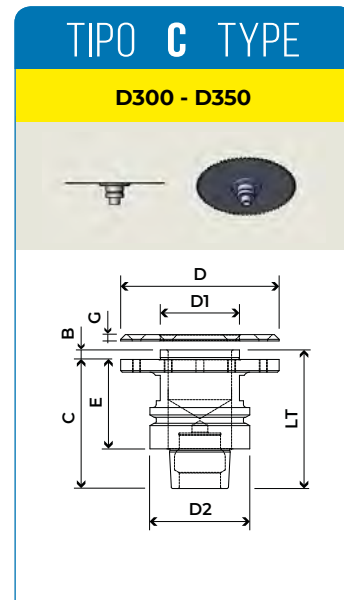
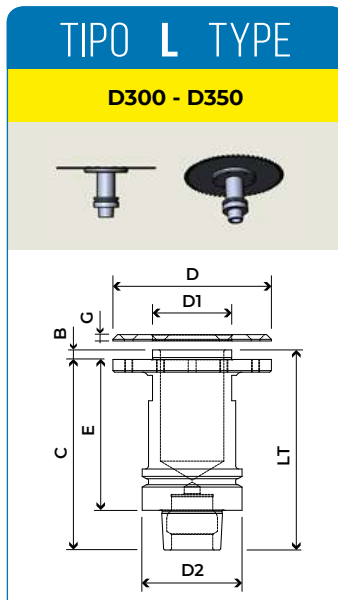
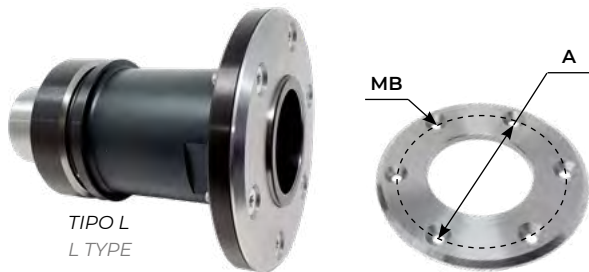

DIMENSIONI DIMENSIONS								ARTICOLI ITEMS			PREZZI €	
D1 DIAM.	E TICK.	D DIAM.	LT T. LENGTH	D2 DIAM.	A TICK.	B TICK.	FT / PH PHIN HOLE	C THICKNESS	G TICKNESS	TIPO TYPE	CODICE / SKU	PRICE €
50	95	100	126	63	80	6	M5 / 6 / INT 80 + D5 / 1 / INT 80	120	4	L	AEM8042001	
50	56	100	87	63	80	6	M5 / 6 / INT 80 + D5 / 1 / INT 80	81	4	C	AEM8042002 NEW	

AEM8030

SMONTACONI UNIVERSALE PER MANDRINI HSK63F - ISO30
UNIVERSAL ASSEMBLY SUPPORTS FOR CHUCKS HSK63F - ISO30

Smontaconi universale per mandrini HSK63F e ISO30 che permette sdi smontare i mandrini senza rovinarne le superfici. La speciale gabbia a rulli bidirezionale bloccando il portautensili permette di smontare o montare la flangia.

Universal cone remover for HSK63F and ISO30 TOOLS HOLDERS which allows you to disassemble the TOOL HOLDER without damaging their surfaces. The special bidirectional BEARING cage, blocking the tool holder, allows the flange to be dismantled or mounted.

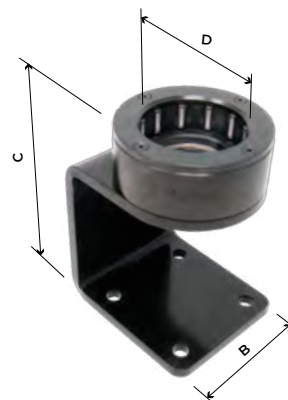

DIMENSIONI DIMENSIONS				ARTICOLI ITEMS		PREZZI €
D DIAMETER	B THICKNESS	C THICKNESS	ADATTO PER SUITABLE FOR	CODICE / SKU	PRICE €	
50	100	160	ISO 30 DIN2080 / HSK 50	AEM8030001		
63	100	160	HSK63 / ISO40 DIN 2080	AEM8030002		

AEM8048

PINZE PER MANDRINI HYDRO ULTRAPRECISE
HIGH PRECISION COLLET FOR HYDRO TOOL HOLDER

Pinze elastiche per mandrini Hydro ultraprecise con tagli a elettroerosione e concentricità di 0,005 mm, rotazione dx e sx.

High precision collet for Hydro tool holder with EDM cuts and concentricity 0,005 mm, RH and LH rotation.

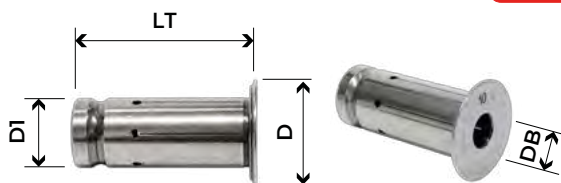

NEW

DIMENSIONI DIMENSIONS						ARTICOLI ITEMS		PREZZI €
PINZA COLLET	DB HOLE DIAMETER	D1 HOLE DIAMETER	D HOLE DIAMETER	LT TOTAL LENGTH	ROTAZIONE ROTATION	CODICE / SKU	PRICE €	
HYDRO	4	20	30	52,5	DX SX	AEM8048006 NEW		
HYDRO	6	20	30	52,5	DX SX	AEM8048001 NEW		
HYDRO	8	20	30	52,5	DX SX	AEM8048002 NEW		
HYDRO	10	20	30	52,5	DX SX	AEM8048003 NEW		
HYDRO	12	20	30	52,5	DX SX	AEM8048004 NEW		
HYDRO	16	20	30	52,5	DX SX	AEM8048005 NEW		
HYDRO	18	20	30	52,5	DX SX	AEM8048007 NEW		

AEM8007

PINZE ELASTICHE ER11 / COLLET ER11

Pinze biconiche intercambiabili standard "ER11" (D= da 2 mm a 6 mm) con intagli assiali intercalati e contrapposti, per il serraggio cilindrico dell'utensile. Adattabile alla maggior parte dei mandrini conici.

Replaceable standard "ER11" collets (from 2 mm to 6 mm). Suitable for most conical chucks.

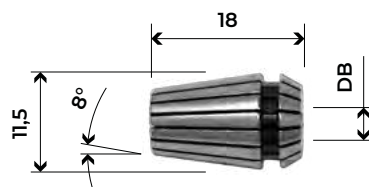

DIMENSIONI DIMENSIONS		ARTICOLI ITEMS				PREZZI €
PINZA COLLET	DB - HOLE DIAMETER	D - DIAMETER	B - TICKNESS	γ° - RANGE	CODICE / SKU	PRICE €
ER11	2	11,5	18	8°	AEM8007001	
ER11	3	11,5	18	8°	AEM8007002	
ER11	4	11,5	18	8°	AEM8007003	
ER11	5	11,5	18	8°	AEM8007004	
ER11	6	11,5	18	8°	AEM8007005	

AEM8008

PINZE ELASTICHE ER16 COLLET ER16

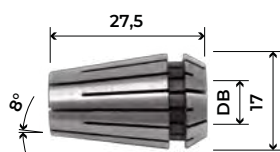

Pinze biconiche intercambiabili standard "ER16" (da 2 mm a 10 mm di diametro) con intagli assiali intercalati e contrapposti, per il serraggio cilindrico integrale dell'utensile. Adattabile alla maggior parte dei mandrini conici.

Replaceable standard "ER16" collets (from 2 mm to 10 mm). Suitable for most conical chucks.

DIMENSIONI DIMENSIONS		ARTICOLI ITEMS		PREZZI €
PINZA COLLET	DB HOLE DIAMETER	CODICE SKU	PRICE €	
ER16	2	AEM8008001		
ER16	3	AEM8008002		
ER16	4	AEM8008003		
ER16	5	AEM8008004		
ER16	6	AEM8008005		
ER16	7	AEM8008006		
ER16	8	AEM8008007		
ER16	9	AEM8008008		
ER16	10	AEM8008009		

AEM8009

PINZE ELASTICHE ER20 COLLET ER20

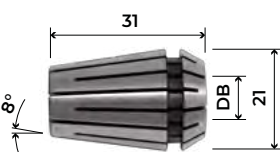

Pinze biconiche intercambiabili standard "ER20" (D= da 2 mm a 13 mm) con intagli assiali intercalati e contrapposti per il serraggio cilindrico dell'utensile. Adattabile alla maggior parte dei mandrini conici.

Replaceable standard "ER20" collets (from 2 mm to 13 mm). Suitable for most conical chucks.

DIMENSIONI DIMENSIONS		ARTICOLI ITEMS		PREZZI €
PINZA COLLET	DB HOLE DIAMETER	CODICE SKU	PRICE €	
ER20	2	AEM8009001		
ER20	3	AEM8009002		
ER20	4	AEM8009003		
ER20	5	AEM8009004		
ER20	6	AEM8009005		
ER20	7	AEM8009006		
ER20	8	AEM8009007		
ER20	9	AEM8009008		
ER20	10	AEM8009009		
ER20	11	AEM8009010		
ER20	12	AEM8009011		
ER20	13	AEM8009012		

AEM8010

PINZE ELASTICHE ER25 COLLET ER25



DIMENSIONI DIMENSIONS		ARTICOLI ITEMS		PREZZI €
PINZA COLLET	DB HOLE DIAMETER	CODICE SKU	PRICE €	
ER25	3	AEM8010001		
ER25	4	AEM8010002		
ER25	5	AEM8010003		
ER25	6	AEM8010004		
ER25	7	AEM8010005		
ER25	8	AEM8010006		
ER25	9	AEM8010007		
ER25	10	AEM8010008		
ER25	11	AEM8010009		
ER25	12	AEM8010010		
ER25	13	AEM8010011		
ER25	14	AEM8010012		
ER25	15	AEM8010013		
ER25	16	AEM8010014		
ER25	17	AEM8010015		
ER25	18	AEM8010016		
ER25	19	AEM8010017		
ER25	20	AEM8010018		

AEM8011

PINZE ELASTICHE ER32 COLLET ER32

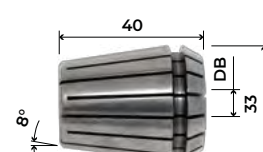

DIMENSIONI DIMENSIONS		ARTICOLI ITEMS		PREZZI €
PINZA COLLET	DB HOLE DIAMETER	CODICE SKU	PRICE €	
ER32	3	AEM8011001		
ER32	4	AEM8011002		
ER32	5	AEM8011003		
ER32	6	AEM8011004		
ER32	7	AEM8011005		
ER32	8	AEM8011006		
ER32	9	AEM8011007		
ER32	10	AEM8011008		
ER32	11	AEM8011009		
ER32	12	AEM8011010		
ER32	13	AEM8011011		
ER32	14	AEM8011012		
ER32	15	AEM8011013		
ER32	16	AEM8011014		
ER32	17	AEM8011015		
ER32	18	AEM8011016		
ER32	19	AEM8011017		
ER32	20	AEM8011018		

AEM8012

PINZE ELASTICHE ER32
AD ALTA PRECISIONE
0,005 MM

COLLET ER32 HIGH
PRECISION 0,005 MM

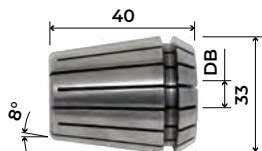

DIMENSIONI DIMENSIONS		ARTICOLI ITEMS	PREZZI €
PINZA COLLET	DB HOLE DIAMETER	CODICE SKU	PRICE €
ER32	3	AEM8012001	
ER32	4	AEM8012002	
ER32	5	AEM8012003	
ER32	6	AEM8012004	
ER32	7	AEM8012005	
ER32	8	AEM8012006	
ER32	9	AEM8012007	
ER32	10	AEM8012008	
ER32	11	AEM8012009	
ER32	12	AEM8012010	
ER32	13	AEM8012011	
ER32	14	AEM8012012	
ER32	15	AEM8012013	
ER32	16	AEM8012014	
ER32	17	AEM8012015	
ER32	18	AEM8012016	
ER32	19	AEM8012017	
ER32	20	AEM8012018	

AEM8014

PINZE ELASTICHE ER 40
ALTA PRECISIONE
0,005 MM

COLLET ER40 HIGH
PRECISION 0,005 MM

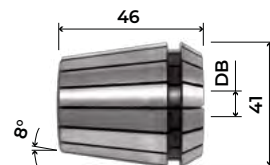

DIMENSIONI DIMENSIONS		ARTICOLI ITEMS	PREZZI €
PINZA COLLET	DB HOLE DIAMETER	CODICE SKU	PRICE €
ER40	3	AEM8014001	
ER40	4	AEM8014002	
ER40	5	AEM8014003	
ER40	6	AEM8014004	
ER40	7	AEM8014005	
ER40	8	AEM8014006	
ER40	9	AEM8014007	
ER40	10	AEM8014008	
ER40	11	AEM8014009	
ER40	12	AEM8014010	
ER40	13	AEM8014011	
ER40	14	AEM8014012	
ER40	15	AEM8014013	
ER40	16	AEM8014014	
ER40	17	AEM8014015	
ER40	18	AEM8014016	
ER40	19	AEM8014017	
ER40	20	AEM8014018	
ER40	25	AEM8014019	

AEM8013

PINZE ELASTICHE ER40
COLLET ER40

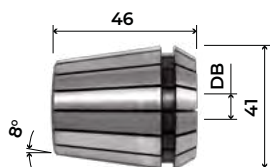

DIMENSIONI DIMENSIONS		ARTICOLI ITEMS	PREZZI €
PINZA COLLET	DB HOLE DIAMETER	CODICE SKU	PRICE €
ER40	3	AEM8013001	
ER40	4	AEM8013002	
ER40	5	AEM8013003	
ER40	6	AEM8013004	
ER40	7	AEM8013005	
ER40	8	AEM8013006	
ER40	9	AEM8013007	
ER40	10	AEM8013008	
ER40	11	AEM8013009	
ER40	12	AEM8013010	
ER40	13	AEM8013011	
ER40	14	AEM8013012	
ER40	15	AEM8013013	
ER40	16	AEM8013014	
ER40	17	AEM8013015	
ER40	18	AEM8013016	
ER40	19	AEM8013017	
ER40	20	AEM8013018	
ER40	22	AEM8013021	NEW
ER40	24	AEM8013020	NEW
ER40	25	AEM8013019	
ER40	26	AEM8013022	NEW
ER40	30	AEM8013023	NEW

AEM8015

PINZE ELASTICHE EOC25
COLLET EOC25

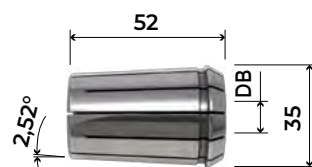

DIMENSIONI DIMENSIONS		ARTICOLI ITEMS	PREZZI €
PINZA COLLET	DB HOLE DIAMETER	CODICE SKU	PRICE €
EOC25	3	AEM8015001	
EOC25	4	AEM8015002	
EOC25	5	AEM8015003	
EOC25	6	AEM8015004	
EOC25	7	AEM8015005	
EOC25	8	AEM8015006	
EOC25	9	AEM8015007	
EOC25	10	AEM8015008	
EOC25	11	AEM8015009	
EOC25	12	AEM8015010	
EOC25	13	AEM8015011	
EOC25	14	AEM8015012	
EOC25	15	AEM8015013	
EOC25	16	AEM8015014	
EOC25	17	AEM8015015	
EOC25	18	AEM8015016	
EOC25	19	AEM8015017	
EOC25	20	AEM8015018	

AEM8041

MOZZO MECCANICO PER TRU-
CIOLATORI / FRESE / LAME
MECHANICAL SLEEVE FOR
HOGGERS / CUTTERS / SAW
BLADES

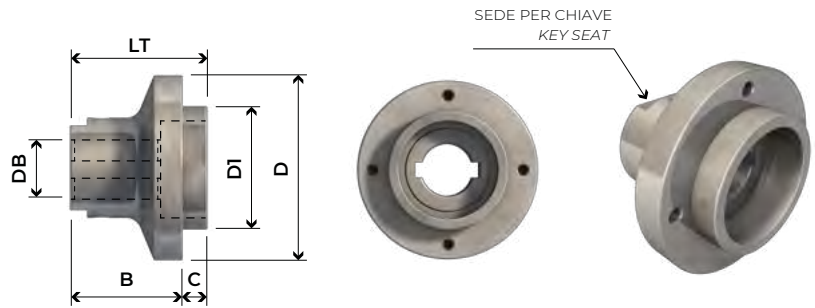

DIMENSIONI DIMENSIONS										ARTICOLI ITEMS	PREZZI €
D1 DIAMETER	DB HOLE DIAMETER	DKN	D DIAMETER	FT / PH PHIN HOLE	LT TOTAL LENGTH	B THICKNESS	C THICKNESS	G	G THICKNESS	CODICE / SKU	PRICE €
60	30+2 DKN	2	91	N4 / M6 / INT 75	71	65	6	50		AEM8041004	NEW
65	30+2 DKN	2	105	N6 / M5 / INT 85	58	54	4	36		AEM8041003	NEW
65	30+2 DKN	2	110	N6 / M5 / INT 90	95	91	4	63		AEM8041005	NEW
65	30+2 DKN	2	105	N6 / M6 / INT 85	42	38,5	3,5	17		AEM8041006	NEW
80	35+2 DKN	2	120	N4 / M8 / INT 100	88,3	72,3	16	63		AEM8041001	
80	40+2 DKN	2	120	N4 / M8 / INT 100	88,3	72,3	16	63		AEM8041002	

AEM8047

MOZZO MECCANICO CON GHIERA DI CHIUSURA PER GRUPPI FRESE
MECHANICAL SLEEVE WITH CLOSING NUT FOR MILLING GROUPS

Mozzo meccanico brunito con ghiera di chiusura per gruppi frese sagomati, fori con dkn e spacchi su mozzo e ghiera per agevolare apertura e chiusura.

Burnished mechanical sleeve with locking ring nut for profiled cutter groups, holes with dkn and slots on sleeve and ring nut to facilitate opening and closing.

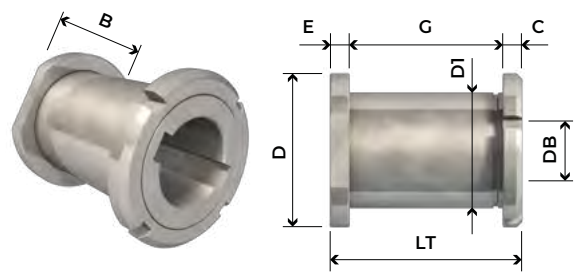

DIMENSIONI DIMENSIONS										ARTICOLI ITEMS	PREZZI €
D1 DIAMETER	DB HOLE DIAMETER	DKN	D DIAMETER	ROTAZIONE ROTATION	LT TOTAL LENGTH	B THICKNESS	C THICKNESS	E THICKNESS	G THICKNESS	CODICE / SKU	PRICE €
60	30	2	79	DX	85	70	10	6	69	AEM8047001	NEW
60	35	2	79	DX	85	70	10	6	69	AEM8047002	NEW
60	40	2	79	DX	85	70	10	6	69	AEM8047003	NEW
60	30	2	79	SX	85	70	10	6	69	AEM8047004	NEW
60	35	2	79	SX	85	70	10	6	69	AEM8047005	NEW
60	40	2	79	SX	85	70	10	6	69	AEM8047006	NEW

AEM8016

GHIERA PER MANDRINO
HSK ER32

CLAMPING NUTS
HSK ER32



DIMENSIONI DIMENSIONS		ARTICOLI ITEMS	PREZZI €
D DIAMETER	ROTAZIONE ROTATION	CODICE / SKU	PRICE €
50	DX	AEM8016001	
50	SX	AEM8016002	

AEM8017

GHIERA PER MANDRINO HSK
ER32 CON CUSCINETTI A SFERA

CLAMPING NUTS HSK
ER32 WITH BEARING



DIMENSIONI DIMENSIONS		ARTICOLI ITEMS	PREZZI €
D DIAMETER	ROTAZIONE ROTATION	CODICE / SKU	PRICE €
50	DX	AEM8017001	
50	SX	AEM8017002	

AEM8018

GHIERA PER MANDRINO
HSK ER40

CLAMPING NUTS
HSK ER40



DIMENSIONI DIMENSIONS		ARTICOLI ITEMS	PREZZI €
D DIAMETER	ROTAZIONE ROTATION	CODICE / SKU	PRICE €
63	DX	AEM8018001	
63	SX	AEM8018002	

AEM8019

GHIERA PER MANDRINO HSK
ER40 CON CUSCINETTI A SFERA

CLAMPING NUTS HSK
ER40 WITH BEARING



DIMENSIONI DIMENSIONS		ARTICOLI ITEMS	PREZZI €
D DIAMETER	ROTAZIONE ROTATION	CODICE / SKU	PRICE €
63	DX	AEM8019001	
63	SX	AEM8019002	

AEM8023

CODOLI DI AGGANCIO PER MACCHINA ALBERTI SENZA FORO
RETAINING STUDS FOR CHUCKS. WITHOUT HOLE.
MACHINES: ALBERTI

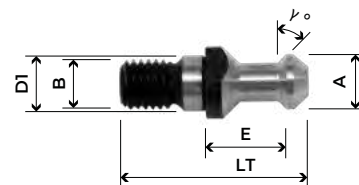

DIMENSIONI DIMENSIONS						ARTICOLI ITEMS	PREZZI €	
B TICKNESS	γ° RANGE	D1 DIAMETER	A TICKNESS	E TICKNESS	LT TOTAL LENGTH	ATTACCO UTENSILE	CODICE / SKU	PRICE €
M6	45°	6,5	7	9,5	23	BT20	AEM8023001	
M8	45°	9	10	13,5	31	BT25	AEM8023002	
M12	45°	13	12,8	19	44	BT30	AEM8023003	

AEM8024

CODOLI DI AGGANCIO PER MACCHINA BIESSE SENZA FORO
RETAINING STUDS FOR CHUCKS. WITHOUT HOLE.
MACHINES: BIESSE

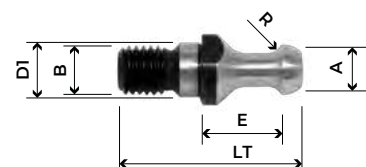

DIMENSIONI DIMENSIONS						ARTICOLI ITEMS	PREZZI €	
B TICKNESS	R RADIUS	D1 DIAMETER	A TICKNESS	E TICKNESS	LT TOTAL LENGTH	ATTACCO UTENSILE	CODICE / SKU	PRICE €
M12	3,2	13	12	24	44	BT30	AEM8024001	

AEM8025

CODOLI DI AGGANCIO PER MACCHINA CMS SENZA FORO
RETAINING STUDS FOR CHUCKS. WITHOUT HOLE.
MACHINES: CMS

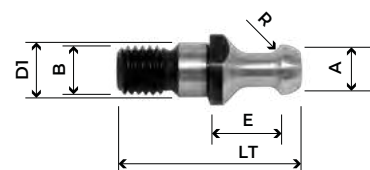

DIMENSIONI DIMENSIONS						ARTICOLI ITEMS	PREZZI €	
B TICKNESS	R RADIUS	D1 DIAMETER	A TICKNESS	E TICKNESS	LT TOTAL LENGTH	ATTACCO UTENSILE	CODICE / SKU	PRICE €
M12	2,4	13	12,8	19	44	BT30	AEM8025001	

AEM8026

CODOLI DI AGGANCIO PER FLANGIA DENTATA SENZA FORO
MACCHINA: SCM
RETAINING STUDS FOR CHUCKS THOOTHED FLANGE. WITHOUT HOLE.
MACHINES: SCM

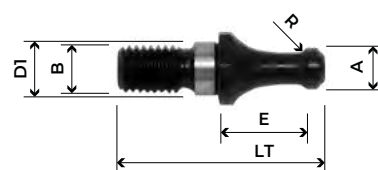

DIMENSIONI DIMENSIONS						ARTICOLI ITEMS	PREZZI €	
B TICKNESS	R RADIUS	D1 DIAMETER	A TICKNESS	E TICKNESS	LT TOTAL LENGTH	ATTACCO UTENSILE	CODICE / SKU	PRICE €
M10	2,3	11	8,5	18,3	42,5	BT30	AEM8026001	

AEM8027

CODOLI DI AGGANCIO DIN 69872 MASTERWOOD E CMS SENZA FORO
RETAINING STUDS FOR CHUCKS DIN 69872. WITHOUT HOLE.
MACHINES: MASTERWOOD E CMS

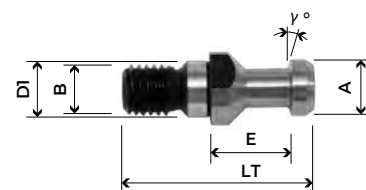

DIMENSIONI DIMENSIONS						ARTICOLI ITEMS	PREZZI €	
B TICKNESS	γ° RANGE	D1 DIAMETER	A TICKNESS	E TICKNESS	LT TOTAL LENGTH	ATTACCO UTENSILE	CODICE / SKU	PRICE €
M12	15°	13	13	19	44	BT30	AEM8027001	

AEM8021

FLANGIA DI RICAMBIO MASCHIO PER MANDRINI ALBERATI
STEEL FLANGE FOR CHUCKS WITH ARBOR - MALE



DIMENSIONI	DIMENSIONS	ARTICOLI	ITEMS	PREZZI €
	D1 DIAMETER		CODICE / SKU	PRICE €
	30		AEM8021001	
	35		AEM8021002	
	40		AEM8021003	

AEM8022

FLANGIA DI RICAMBIO FEMMINA PER MANDRINI ALBERATI
STEEL FLANGE FOR CHUCKS WITH ARBOR - FEMALE



DIMENSIONI	DIMENSIONS	ARTICOLI	ITEMS	PREZZI €
	D1 DIAMETER		CODICE / SKU	PRICE €
	30		AEM8022001	
	35		AEM8022002	
	40		AEM8022003	

AEM8028

CHIAVI PER GHIERE ER DIN6499 STANDARD
C-SPANNER FOR CLAMPING NUTS ER DIN6499 STANDARD



DIMENSIONI	DIMENSIONS	ARTICOLI	ITEMS	PREZZI €
	TIPOLOGIA GHIERA CLAMPING NUTS		CODICE / SKU	PRICE €
	ER32		AEM8028001	
	ER40		AEM8028002	

AEM8029

CHIAVI PER GHIERE A SETTORE ER DIN6388 PER MANDRINI EOC
C-SPANNER FOR CLAMPING NUTS ER DIN6388 STANDARD



DIMENSIONI	DIMENSIONS	ARTICOLI	ITEMS	PREZZI €
	TIPOLOGIA GHIERA CLAMPING NUTS		CODICE / SKU	PRICE €
	ER32		AEM8029001	
	ER40		AEM8029002	

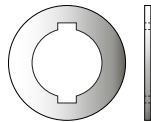
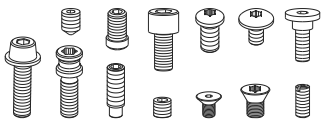
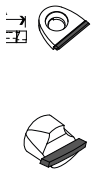
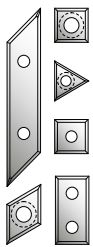

RICAMBI

SPARE PARTS



DIAREX RIC9046

RIVESTIMENTO SU FRESE AL WIDIA ELICOIDALI
COATING ON HELICAL CARBIDE SHANK CUTTER

NEW

215
PAG.



RIC9020

COLTELLINI REVERSIBILI IN HW
REVERSIBLE KNIVES IN HW

221
PAG.



RIC9013

CHIAVI
KEYS

216
PAG.



RIC9021

COLTELLINI REVERSIBILI IN HW
REVERSIBLE KNIVES IN HW

221
PAG.



RIC9001

RICAMBIO INSERTO IN DIAMANTE PER LIGHT FLEX TRBL
PCD SPARE INSERT FOR LIGHT FLEX TRBL

216
PAG.



RIC9022

COLTELLINI REVERSIBILI IN HW
REVERSIBLE KNIVES IN HW

221
PAG.



RIC9010

RICAMBI PER FRESE AD INSERTI MODELLO LEITZ
PCD SPARE INSERT FOR CUTTER TYPE LEITZ

217
PAG.



RIC9023

COLTELLINI REVERSIBILI IN HW
REVERSIBLE KNIVES IN HW

221
PAG.



RIC9012

RICAMBIO INSERTO IN DIAMANTE PER BORDATRICI IN LEGA LEGGERA LIGHT FLEX ECO
PCD SPARE INSERT FOR EDGE-BANDER JOINTING CUTTER MOD. LIGHT FLEX ECO

217
PAG.



RIC9024

COLTELLINI REVERSIBILI IN HW
REVERSIBLE KNIVES IN HW

222
PAG.

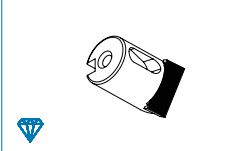

RIC9045

RICAMBIO INSERTO IN DIAMANTE PER FRESE RETTIFICA DIAMETRO COSTANTE DIAFIX
SPARE DIAMOND INSERT FOR CONSTANT DIAMETER ON JOINTING CUTTERS DIAFIX

NEW

218
PAG.



RIC9025

COLTELLINI REVERSIBILI IN HW
REVERSIBLE KNIVES IN HW

222
PAG.



RIC9014

SEGER DI FISSAGGIO
FIXING SEGER RING

218
PAG.



RIC9026

COLTELLINI REVERSIBILI IN HW
REVERSIBLE KNIVES IN HW

222
PAG.



RIC9016

COLTELLINI REVERSIBILI IN DIAMANTE
PCD REVERSIBLE KNIVES

218
PAG.



RIC9027

COLTELLINI REVERSIBILI IN HW
REVERSIBLE KNIVES IN HW

222
PAG.

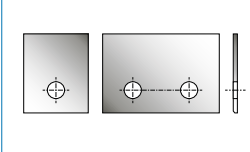

COL SAG RIC9004

COLTELLI SAGOMATI IN HW PROFILO RICHIESTO DAL CLIENTE
HW PROFILED KNIFE DIFFERENT PROFILES UP ON REQUEST

219
PAG.



RIC9029

COLTELLINI REVERSIBILI IN HW
REVERSIBLE KNIVES IN HW

222
PAG.

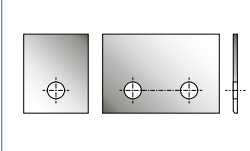

RIC9019

COLTELLI GREZZI DA PROFILARE
HW PROFILED KNIF

220
PAG.



RIC9030

COLTELLINI REVERSIBILI IN HW
REVERSIBLE KNIVES IN HW

222
PAG.

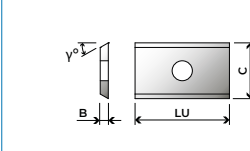

RIC9008

COLTELLINI REVERSIBILI IN HW
REVERSIBLE KNIVES IN HW

221
PAG.



RIC9031

COLTELLINI REVERSIBILI IN HW
REVERSIBLE KNIVES IN HW

223
PAG.

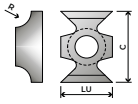

RIC9032

COLTELLINI REVERSIBILI IN HW
REVERSIBLE KNIVES IN HW

223
PAG.

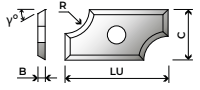

RIC9033

COLTELLINI REVERSIBILI IN HW
REVERSIBLE KNIVES IN HW

223
PAG.

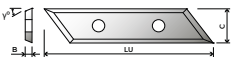

RIC9034

COLTELLINI REVERSIBILI IN HW
REVERSIBLE KNIVES IN HW

223
PAG.

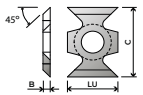

RIC9035

COLTELLINI REVERSIBILI IN HW
REVERSIBLE KNIVES IN HW

223
PAG.

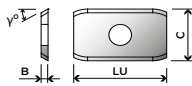

RIC9037

COLTELLINI REVERSIBILI IN HW
REVERSIBLE KNIVES IN HW

224
PAG.

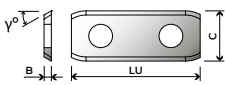

RIC9038

COLTELLINI REVERSIBILI IN HW
REVERSIBLE KNIVES IN HW

224
PAG.

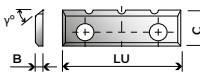

RIC9039

COLTELLINI REVERSIBILI IN HW
REVERSIBLE KNIVES IN HW

224
PAG.

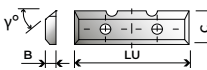

RIC9036

COLTELLINI REVERSIBILI IN HW
REVERSIBLE KNIVES IN HW

224
PAG.

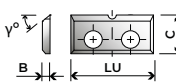

RIC9028

COLTELLINI REVERSIBILI IN HW
REVERSIBLE KNIVES IN HW

224
PAG.

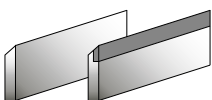

RIC9015

COLTELLI DA PIALLA
KNIFE FOR PLANNER MACHINE

225
PAG.

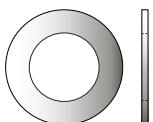

RIC9009

SPESSORI - ANELLI DISTANZIA-
TORI AD ESECUZIONE
TRANCIATA SENZA RETTIFICA.
SPACERS RINGS NO RECTIFIED

227
PAG.

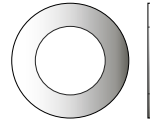

RIC9017

SPESSORI - ANELLI DISTANZIA-
TORI RETTIFICATI E CEMENTATI
SPACERS RINGS
RECTIFIED AND CEMENTED

227
PAG.

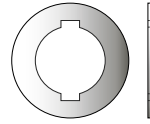

RIC9018

SPESSORI - ANELLI DISTANZIA-
TORI RETTIFICATI CON DOPPIA
CHIAVETTA
SPACERS RINGS RECTIFIED
WITH DOUBLE KEY

227
PAG.



RIC9007

VITI
SCREW

228
PAG.

RAINBOW RIC9046

NEW

RIVESTIMENTO SU FRESE AL WIDIA ELICOIDALI COATING ON HELICAL CARBIDE SHANK CUTTER

Problemi con la durata delle frese al widia? Materiali particolarmente abrasivi? Prova il nostro rivestimento RAINBOW. Rivestimento per frese al widia elicoidali durata 3x triplicata rispetto al widia standard. Consegna in una settimana. Applicabile su tutti gli utensili al widia prodotti da Microtech e non.

Problems with the life of carbide tools? Materials particularly abrasives? Try our RAINBOW coating and tool life is 3 times more compare to a standard carbide tool. Applicable on all widia tools produced by Microtech and not.



DIAMETRO DI PARTENZA INFERIORE O UGUALE A: START DIAMETER LOWER OR EQUAL TO:		LUNGHEZZA TOTALE FRESA INFERIORE O UGUALE A: TOTAL LENGTH OF THE CUTTER LOWER OR EQUAL TO:		ARTICOLI	ITEMS	PREZZI €
D	LT	D	LT	CODICE / SKU		PRICE €
DIAMETER	TOT. LENGTH	DIAMETER	TOT. LENGTH			
3	75			RIC9046001	NEW	
3	100			RIC9046002	NEW	
4	75			RIC9046003	NEW	
4	100			RIC9046004	NEW	
4	150			RIC9046005	NEW	
6	75			RIC9046006	NEW	
6	100			RIC9046007	NEW	
6	150			RIC9046008	NEW	
8	75			RIC9046009	NEW	
8	100			RIC9046010	NEW	
8	150			RIC9046011	NEW	
10	75			RIC9046012	NEW	
10	100			RIC9046013	NEW	
10	150			RIC9046014	NEW	
10	200			RIC9046015	NEW	
12	75			RIC9046016	NEW	
12	100			RIC9046017	NEW	
12	150			RIC9046018	NEW	
12	200			RIC9046019	NEW	
14	75			RIC9046020	NEW	
14	100			RIC9046021	NEW	
14	150			RIC9046022	NEW	
14	200			RIC9046023	NEW	
16	100			RIC9046024	NEW	
16	150			RIC9046025	NEW	
16	200			RIC9046026	NEW	
16	300			RIC9046027	NEW	
18	100			RIC9046028	NEW	
18	150			RIC9046029	NEW	
18	200			RIC9046030	NEW	
20	100			RIC9046031	NEW	
20	150			RIC9046032	NEW	
20	200			RIC9046033	NEW	
22	150			RIC9046034	NEW	
22	200			RIC9046035	NEW	
22	300			RIC9046036	NEW	
26	100			RIC9046037	NEW	
26	200			RIC9046038	NEW	
26	300			RIC9046039	NEW	
30	150			RIC9046040	NEW	
30	200			RIC9046041	NEW	
30	300			RIC9046042	NEW	

RIC9013

CHIAVI
KEYS

DIMENSIONI DIMENSIONS		ARTICOLI ITEMS	PREZZI €
		CODICE / SKU	PRICE €
	CHIAVE ESAGONALE 0,9 mm per viti M2	RIC9013001	
	CHIAVE ESAGONALE 1,5 mm per viti M3	RIC9013002	
	CHIAVE ESAGONALE 2 mm	RIC9013003	
	CHIAVE ESAGONALE 3/12 per viti 1/8 W	RIC9013004	
	CHIAVE ESAGONALE 2,5 per viti M4	RIC9013005	
	CHIAVE ESAGONALE 3 mm	RIC9013006	
	CHIAVE ESAGONALE 4 mm	RIC9013007	
	CHIAVE ESAGONALE 5 mm	RIC9013008	
	CHIAVE ESAGONALE 6 mm	RIC9013009	
	CHIAVE TORX T8	RIC9013010	
	CHIAVE TORX T9	RIC9013011	
	CHIAVE TORX T15	RIC9013012	
	CHIAVE TORX T20	RIC9013013	
	CHIAVE TORX T25	RIC9013014	
	CHIAVE TORX T30	RIC9013015	

RIC9001

RICAMBIO INSERTO IN DIAMANTE PER LIGHT FLEX TRBL
PCD SPARE INSERT FOR LIGHT FLEX TRBL

Ricambio inserto in diamante per bordatrici in lega leggera LIGHT FLEX.

PCD spare insert for edgebander jointing cutter with alu body.

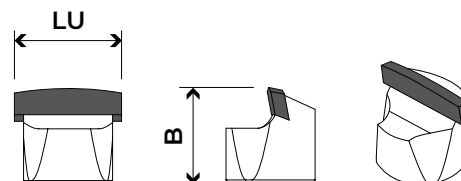

DIMENSIONI DIMENSIONS				ARTICOLI ITEMS	PREZZI €
D DIAMETER	β° AXIAL ANGLE	B THICKNESS	LU USEFUL LENGTH	CODICE / SKU	PRICE €
100	45°	14	15	RIC9001002	
125	45°	14	15	RIC9001003	
150	45°	14	15	RIC9001004	
80	54,9°	14	15	RIC9001005	
100	54,9°	14	15	RIC9001006	
125	54,9°	14	15	RIC9001007	
150	54,9°	14	15	RIC9001008	
200	45°	14	15	RIC9001009	
80	45°	14	15	RIC9001010	
100	35°	14	15	RIC9001011	
80	35°	14	15	RIC9001012	
125	35°	14	15	RIC9001013	
85	45°	14	15	RIC9001014	
180	45°	14	15	RIC9001015	
85	35°	14	15	RIC9001016	
13	35°	14	15	RIC9001017	
13	45°	14	15	RIC9001018	
13	54,9°	14	15	RIC9001019	

VITE INSERT SCREW		ARTICOLI ITEMS	PREZZI €
 VITI M7 TORX T30		RIC9002001	

RIC9010

RICAMBI PER FRESE AD INSERTI MODELLO LEITZ
PCD SPARE INSERT FOR CUTTER TYPE LEITZ

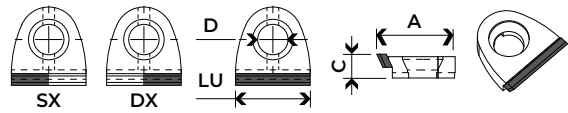

DIMENSIONI DIMENSIONS						ARTICOLI ITEMS	PREZZI €	
A THICKNESS	D DIAMETER	LU USEFUL LENGTH	C THICKNESS	ROTAZIONE ROTATION	β° AXIAL ANGLE	TIPO TYPE	CODICE / SKU	PRICE €
14,5	60	14	4,3	DX/SX	30°		RIC9010001	
14,5	70	14	4,3	DX/SX	30°		RIC9010002	
14,5	80	14	4,3	DX/SX	30°		RIC9010003	
14,5	100	14	4,3	DX/SX	30°		RIC9010004	
14,5	125	14	4,3	DX/SX	30°		RIC9010005	
14,5		14	4,3	DX/SX	30°	DA 60 A 200 CON PCD SENZA AFFILATURA	RIC9010006	
14,5		14	4,3	DX/SX	30°	DA 60 A 200 SENZA PCD	RIC9010007	
14,5	60	7	4,3	DX	30°		RIC9010008	
14,5	70	7	4,3	DX	30°		RIC9010009	
14,5	80	7	4,3	DX	30°		RIC9010010	
14,5	100	7	4,3	DX	30°		RIC9010011	
14,5	125	7	4,3	DX	30°		RIC9010012	
14,5		7	4,3	DX	30°	DA 60 A 200 CON PCD SENZA AFFILATURA	RIC9010013	
14,5	60	7	4,3	SX	30°		RIC9010014	
14,5	70	7	4,3	SX	30°		RIC9010015	
14,5	80	7	4,3	SX	30°		RIC9010016	
14,5	100	7	4,3	SX	30°		RIC9010017	
14,5	125	7	4,3	SX	30°		RIC9010018	
14,5		7	4,3	SX	30°	DA 60 A 200 CON PCD SENZA AFFILATURA	RIC9010019	

RIC9012

RICAMBIO INSERTO IN DIAMANTE PER BORDATRICI IN LEGA LEGGERA LIGHT FLEX ECO
PCD SPARE INSERT FOR EDGE BANDER JOINTING CUTTER MOD. LIGHT FLEX ECO

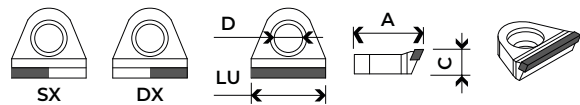

DIMENSIONI DIMENSIONS						ARTICOLI ITEMS	PREZZI €
A THICKNESS	D DIAMETER	LU USEFUL LENGTH	C THICKNESS	ROTAZIONE ROTATION	β° AXIAL ANGLE	CODICE / SKU	PRICE €
14	60	15	5	DX/SX	30°	RIC9012001	
14	70	15	5	DX/SX	30°	RIC9012024	
14	80	15	5	DX/SX	30°	RIC9012002	
14	100	15	5	DX/SX	30°	RIC9012003	
14	125	15	5	DX/SX	30°	RIC9012004	
14	60	15	5	DX/SX	45°	RIC9012005	
14	70	15	5	DX/SX	45°	RIC9012028	
14	80	15	5	DX/SX	45°	RIC9012006	
14	100	15	5	DX/SX	45°	RIC9012007	
14	125	15	5	DX/SX	45°	RIC9012008	
14	60	15	5	DX/SX	54,9°	RIC9012009	
14	70	15	5	DX/SX	54,9°	RIC9012025	
14	80	15	5	DX/SX	54,9°	RIC9012010	
14	100	15	5	DX/SX	54,9°	RIC9012011	
14	125	15	5	DX/SX	54,9°	RIC9012012	
14	60	7	5	DX	30°	RIC9012013	
14	80	7	5	DX	30°	RIC9012014	
14	100	7	5	DX	30°	RIC9012015	
14	125	7	5	DX	30°	RIC9012016	
14	60	7	5	SX	30°	RIC9012017	
14	80	7	5	SX	30°	RIC9012018	
14	100	7	5	SX	30°	RIC9012019	
14	125	7	5	SX	30°	RIC9012020	
14	100	7	5	DX	45°	RIC9012022	
14	100	7	5	SX	45°	RIC9012023	
14	85	15	5	DX/SX	30°	RIC9012027	

RIC9045

RICAMBIO INSERTO IN DIAMANTE PER FRESE
RETTIFICA DIAMETRO COSTANTE DIAFIX

SPARE DIAMOND INSERT FOR CONSTANT
DIAMETER ON JOINTING CUTTERS DIAFIX

Ricambio inserto in diamante per bordatrici in acciaio DIAFIX a diametro costante per tutte le future riaffilature.

Spare diamond insert for constant diameter for all future regrinding. DIAFIX steel body to be used on edge banding machines.

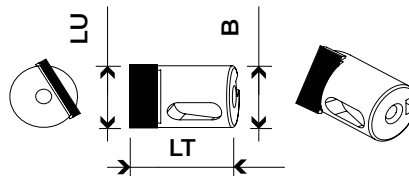

DIMENSIONI DIMENSIONS						ARTICOLI ITEMS	PREZZI €
LT TOT. LENGTH	D DIAMETER	LU USEFUL LENGTH	B THICKNESS	ROTAZIONE ROTATION	β° AXIAL ANGLE	CODICE / SKU	PRICE €
21	100	14	14	DX	30°	RIC9045001 NEW	
21	100	14	14	SX	30°	RIC9045002 NEW	
21	125	14	14	DX	30°	RIC9045003 NEW	
21	125	14	14	SX	30°	RIC9045004 NEW	

RIC9014

SEGER DI FISSAGGIO
FIXING SEGER RING

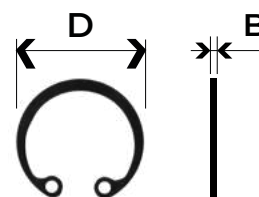

DIMENSIONI DIMENSIONS			ARTICOLI ITEMS	PREZZI €
D DIAMETER	D ATTACCO DIAMETER	B THICKNESS	CODICE / SKU	PRICE €
13,6	12	1	RIC9014001	
18	16	1	RIC9014002	
20,3	18	1,2	RIC9014003	
22,4	20	1,2	RIC9014004	
24,7	22	1,2	RIC9014005	
27,6	25	1,2	RIC9014006	
16	HSK32	1	RIC9014007	
25,8	HSK25	1,2	RIC9014008	

RIC9016

COLTELLINI REVERSIBILI IN DIAMANTE
PCD REVERSIBLE KNIVES

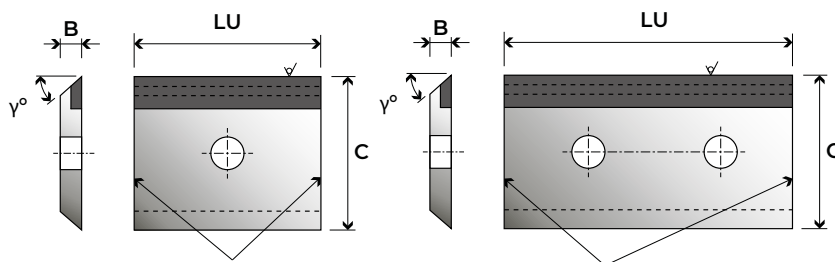

NON TAGLIANTE SUL FIANCO / NO LATERAL CUTTING

DIMENSIONI DIMENSIONS						ARTICOLI ITEMS	PREZZI €
LU USEFUL LENGTH	C THICKNESS	B THICKNESS	γ° RANGE	FT / PH PHIN HOLE	Z ACTUAL TEETH	CODICE / SKU	PRICE €
12	12	1,5	25°	1 LATO A 25°	1	RIC9016008 NEW	
15	12	1,5	25°	1 LATO A 25°	1	RIC9016001	
20	12	1,5	25°	1 LATO A 25°	1	RIC9016002	
30	12	1,5	25°	1 LATO A 25°	1	RIC9016003	
35	12	1,5	25°	1 LATO A 25°	1	RIC9016004	
40	12	1,5	25°	1 LATO A 25°	1	RIC9016005	
50	12	1,5	25°	1 LATO A 25°	1	RIC9016006	
60	12	1,5	25°	1 LATO A 25°	1	RIC9016007	

COL SAG RIC9004

COLTELLI SAGOMATI IN HW
PROFILO RICHIESTO DAL CLIENTE

HW PROFILED KNIFE
DIFFERENT PROFILES UP ON REQUEST

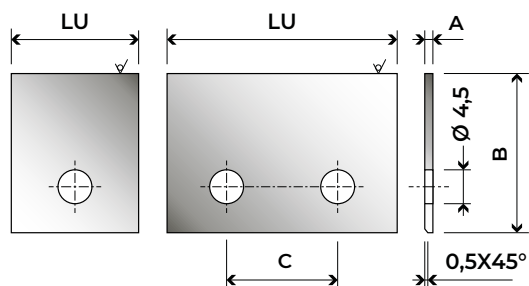

DIMENSIONI DIMENSIONS				ARTICOLI ITEMS		4 PZ. PREZZI €	12 PZ. PREZZI €	24 PZ. PREZZI €
LU USEFUL LENGTH	B THICKNESS	A THICKNESS	C THICKNESS	FT / PH PHIN HOLE	CODICE / SKU	4 PZ. PRICES €	12 PZ. PRICES €	24 PZ. PRICES €
15	15	2	/	1	COD SPECIALE			
15	20	2	/	1	COD SPECIALE			
15	25	2	/	1	COD SPECIALE			
15	30	2	/	1	COD SPECIALE			
16	15	2	/	1	COD SPECIALE			
16	20	2	/	1	COD SPECIALE			
16	25	2	/	1	COD SPECIALE			
20	20	2	/	1	COD SPECIALE			
20	25	2	/	1	COD SPECIALE			
20	30	2	/	1	COD SPECIALE			
20	35	2	/	1	COD SPECIALE			
25	20	2	/	1	COD SPECIALE			
25	25	2	/	1	COD SPECIALE			
25	30	2	/	1	COD SPECIALE			
25	35	2	/	1	COD SPECIALE			
25	40	2	/	1	COD SPECIALE			
30	20	2	/	1	COD SPECIALE			
30	25	2	/	1	COD SPECIALE			
30	30	2	/	1	COD SPECIALE			
30	35	2	/	1	COD SPECIALE			
30	40	2	/	1	COD SPECIALE			
35	25	2	/	1	COD SPECIALE			
35	30	2	/	1	COD SPECIALE			
35	35	2	/	1	COD SPECIALE			
35	50	2	/	1	COD SPECIALE			
30	20	2	14	2	COD SPECIALE			
30	25	2	14	2	COD SPECIALE			
30	30	2	14	2	COD SPECIALE			
30	35	2	14	2	COD SPECIALE			
30	40	2	14	2	COD SPECIALE			
35	25	2	14	2	COD SPECIALE			
35	30	2	14	2	COD SPECIALE			
35	35	2	14	2	COD SPECIALE			
35	40	2	14	2	COD SPECIALE			
40	20	2	26	2	COD SPECIALE			
40	25	2	26	2	COD SPECIALE			
40	30	2	26	2	COD SPECIALE			
40	35	2	26	2	COD SPECIALE			
40	40	2	26	2	COD SPECIALE			
40	45	2	26	2	COD SPECIALE			
50	20	2	26	2	COD SPECIALE			
50	25	2	26	2	COD SPECIALE			
50	30	2	26	2	COD SPECIALE			
50	35	2	26	2	COD SPECIALE			
50	40	2	26	2	COD SPECIALE			
60	20	2	26	2	COD SPECIALE			
60	25	2	26	2	COD SPECIALE			
60	30	2	26	2	COD SPECIALE			
60	35	2	26	2	COD SPECIALE			
60	40	2	26	2	COD SPECIALE			
80	20	2	26	2	COD SPECIALE			
80	25	2	26	2	COD SPECIALE			
80	30	2	26	2	COD SPECIALE			
80	35	2	26	2	COD SPECIALE			

RIC9019

COLTELLI GREZZI DA PROFILARE
HW PROFILED KNIFE

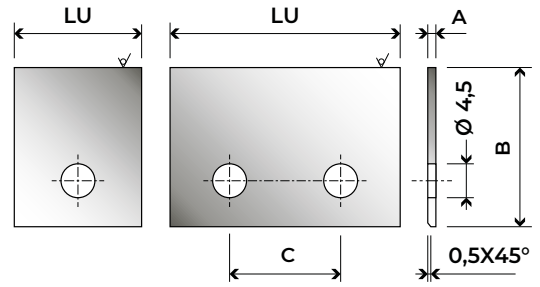

DIMENSIONI DIMENSIONS				ARTICOLI ITEMS		PREZZI €
LU USEFUL LENGTH	B THICKNESS	A THICKNESS	C THICKNESS	FT / PH PHIN HOLE	CODICE / SKU	PRICE €
15	15	2	/	1	RIC9019001	
15	20	2	/	1	RIC9019002	
15	25	2	/	1	RIC9019003	
15	30	2	/	1	RIC9019004	
16	15	2	/	1	RIC9019005	
16	20	2	/	1	RIC9019006	
16	25	2	/	1	RIC9019007	
20	20	2	/	1	RIC9019008	
20	25	2	/	1	RIC9019009	
20	30	2	/	1	RIC9019010	
20	35	2	/	1	RIC9019011	
25	20	2	/	1	RIC9019012	
25	25	2	/	1	RIC9019013	
25	30	2	/	1	RIC9019014	
25	35	2	/	1	RIC9019015	
25	40	2	/	1	RIC9019016	
30	20	2	/	1	RIC9019017	
30	25	2	/	1	RIC9019018	
30	30	2	/	1	RIC9019019	
30	35	2	/	1	RIC9019020	
30	40	2	/	1	RIC9019021	
35	25	2	/	1	RIC9019022	
35	30	2	/	1	RIC9019023	
35	35	2	/	1	RIC9019024	
35	50	2	/	1	RIC9019025	
30	20	2	14	2	RIC9019026	
30	25	2	14	2	RIC9019027	
30	30	2	14	2	RIC9019028	
30	35	2	14	2	RIC9019029	
30	40	2	14	2	RIC9019030	
35	25	2	14	2	RIC9019031	
35	30	2	14	2	RIC9019032	
35	35	2	14	2	RIC9019033	
35	40	2	14	2	RIC9019034	
40	20	2	26	2	RIC9019035	
40	25	2	26	2	RIC9019036	
40	30	2	26	2	RIC9019037	
40	35	2	26	2	RIC9019038	
40	40	2	26	2	RIC9019039	
40	45	2	26	2	RIC9019040	
50	20	2	26	2	RIC9019041	
50	25	2	26	2	RIC9019042	
50	30	2	26	2	RIC9019043	
50	35	2	26	2	RIC9019044	
50	40	2	26	2	RIC9019045	
60	20	2	26	2	RIC9019046	
60	25	2	26	2	RIC9019047	
60	30	2	26	2	RIC9019048	
60	35	2	26	2	RIC9019049	
60	40	2	26	2	RIC9019050	
80	20	2	26	2	RIC9019051	
80	25	2	26	2	RIC9019052	
80	30	2	26	2	RIC9019053	
80	35	2	26	2	RIC9019054	

RIC9008

COLTELLINI REVERSIBILI IN HW
REVERSIBLE KNIVES IN HW

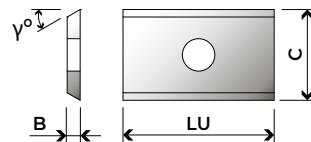

DIMENSIONI DIMENSIONS				ARTICOLI ITEMS	PREZZI €		
LU USEFUL LENGTH	C THICKNESS	B THICKNESS	γ° RANGE	TYPE	Z ACTUAL TEETH	CODICE / SKU	PRICE €
7,5	12	1,5	35°	2 LATI 35°	2	RIC9008001	
7,65	12	1,5	35°	2 LATI 35°	2	RIC9008002	
9,6	12	1,5	35°	2 LATI 35°	2	RIC9008003	
15	12	1,5	35°	2 LATI 35°	2	RIC9008004	
20	12	1,5	35°	2 LATI 35°	2	RIC9008006	

RIC9020

COLTELLINI REVERSIBILI IN HW
REVERSIBLE KNIVES IN HW

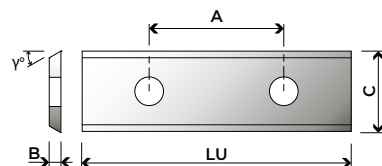

DIMENSIONI DIMENSIONS				ARTICOLI ITEMS	PREZZI €				
LU USEFUL LENGTH	C THICKNESS	B THICKNESS	A THICKNESS	γ° RANGE	FT/PH	TYPE	Z ACTUAL TEETH	CODICE / SKU	PRICE €
25	12	1,5	14	35°	2	2 LATI 35°	2	RIC9020001	
30	12	1,5	14	35°	2	2 LATI 35°	2	RIC9020002	
30	12	1,5	14	45°	2	2 LATI 45°	2	RIC9020003	
40	12	1,5	26	35°	2	2 LATI 35°	2	RIC9020004	
50	12	1,5	26	35°	2	2 LATI 35°	2	RIC9020005	
60	12	1,5	26	35°	2	2 LATI 35°	2	RIC9020006	

RIC9021

COLTELLINI REVERSIBILI IN HW
REVERSIBLE KNIVES IN HW

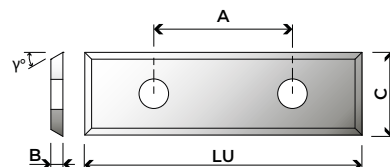

DIMENSIONI DIMENSIONS				ARTICOLI ITEMS	PREZZI €				
LU USEFUL LENGTH	C THICKNESS	B THICKNESS	A THICKNESS	γ° RANGE	FT/PH	TYPE	Z ACTUAL TEETH	CODICE / SKU	PRICE €
29,5	9	1,5	14	35°	2	4 LATI 35°	4	RIC9021001	
29,5	12	1,5	14	35°	2	4 LATI 35°	4	RIC9021002	
39,5	9	1,5	26	35°	2	4 LATI 35°	4	RIC9021003	
39,5	12	1,5	26	35°	2	4 LATI 35°	4	RIC9021004	
49,5	9	1,5	26	35°	2	4 LATI 35°	4	RIC9021005	
49,5	12	1,5	26	35°	2	4 LATI 35°	4	RIC9021006	

RIC9022

COLTELLINI REVERSIBILI IN HW
REVERSIBLE KNIVES IN HW

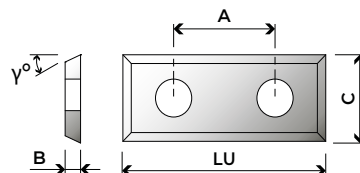

DIMENSIONI DIMENSIONS				ARTICOLI ITEMS	PREZZI €				
LU USEFUL LENGTH	C THICKNESS	B THICKNESS	A THICKNESS	γ° RANGE	FT/PH	TYPE	Z ACTUAL TEETH	CODICE / SKU	PRICE €
28,3	12	1,5	14	35°	2	4 LATI 35°	4	RIC9022001	
48,3	12	1,5	26	35°	2	4 LATI 35°	4	RIC9022002	

RIC9023

COLTELLINI REVERSIBILI IN HW
REVERSIBLE KNIVES IN HW

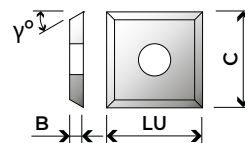

DIMENSIONI DIMENSIONS				ARTICOLI ITEMS	PREZZI €			
LU USEFUL LENGTH	C THICKNESS	B THICKNESS	γ° RANGE	TYPE	FORO BORE	Z ACTUAL TEETH	CODICE / SKU	PRICE €
10,5	10,5	1,5	35°	4 LATI 35°	NORMALE D 4	4	RIC9023001	
12	12	1,5	35°	4 LATI 35°	NORMALE D 4	4	RIC9023002	
13,6	13,6	2	30°	4 LATI 30°	SVASATO	4	RIC9023003	
14	14	1,2	30°	4 LATI 30°	SVASATO	4	RIC9023004	
14	14	2	30°	4 LATI 30°	SVASATO	4	RIC9023005	
14	14	2	45°	4 LATI 45°	SVASATO	4	RIC9023006	

RIC9024

COLTELLINI REVERSIBILI IN HW
REVERSIBLE KNIVES IN HW

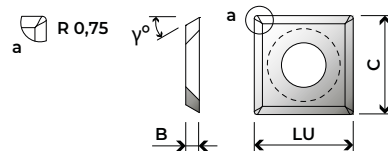

DIMENSIONI		DIMENSIONS			ARTICOLI		ITEMS	PREZZI €
LU	C	B	R	γ°	TYPE	Z	CODICE / SKU	PRICE €
USEFUL LENGTH	THICKNESS	THICKNESS	RADIUS	RANGE		ACTUAL TEETH		
12	12	1,5	0,75	30°	4 LATI 30°	4	RIC9024001	
14	14	2	0,75	30°	4 LATI 30°	4	RIC9024002	

RIC9025

COLTELLINI REVERSIBILI IN HW
REVERSIBLE KNIVES IN HW

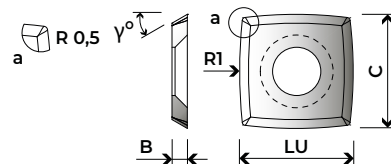

DIMENSIONI		DIMENSIONS			ARTICOLI		ITEMS	PREZZI €	
LU	C	B	R1	R	γ°	TYPE	Z	CODICE / SKU	PRICE €
USEFUL LENGTH	THICKNESS	THICKNESS	RADIUS	RADIUS	RANGE		ACTUAL TEETH		
15	15	2,5	115	0,5	30°	4 LATI 30°	4	RIC9025001	
15	15	2,5	150	0,5	30°	4 LATI 30°	4	RIC9025002	

RIC9026

COLTELLINI REVERSIBILI IN HW
REVERSIBLE KNIVES IN HW

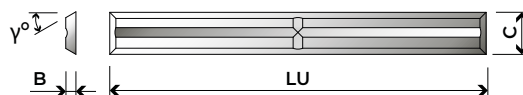

DIMENSIONI		DIMENSIONS			ARTICOLI		ITEMS	PREZZI €
LU	C	B	γ°	TYPE	Z	CODICE / SKU	PRICE €	
USEFUL LENGTH	THICKNESS	THICKNESS	RANGE		ACTUAL TEETH			
20	4,1	1,1	35°	4 LATI 35°	4	RIC9026001		
26	6,5	1,1	35°	4 LATI 35°	4	RIC9026004	NEW	
30	5,5	1,1	35°	4 LATI 35°	4	RIC9026002		
50	5,5	1,1	35°	4 LATI 35°	4	RIC9026003		

RIC9027

COLTELLINI REVERSIBILI IN HW
REVERSIBLE KNIVES IN HW

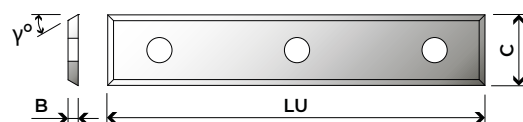

DIMENSIONI		DIMENSIONS			ARTICOLI		ITEMS	PREZZI €
LU	C	B	FT/PH	γ°	TYPE	Z	CODICE / SKU	PRICE €
USEFUL LENGTH	THICKNESS	THICKNESS		RANGE		ACTUAL TEETH		
50	9	1,5	3/INT.37	35°	4 LATI 35°	4	RIC9027001	

RIC9029

COLTELLINI REVERSIBILI IN HW
REVERSIBLE KNIVES IN HW

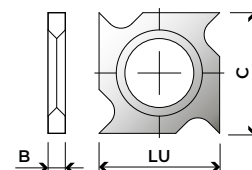

DIMENSIONI		DIMENSIONS			ARTICOLI		ITEMS	PREZZI €
LU	C	B	Z	CODICE / SKU	PRICE €			
USEFUL LENGTH	THICKNESS	THICKNESS	ACTUAL TEETH					
18	18	1,95	4	RIC9029001				
18	18	2,45	4	RIC9029002				

RIC9030

COLTELLINI REVERSIBILI IN HW
REVERSIBLE KNIVES IN HW

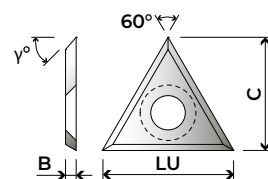

DIMENSIONI		DIMENSIONS			ARTICOLI		ITEMS	PREZZI €
LU	C	B	γ°	TYPE	Z	CODICE / SKU	PRICE €	
USEFUL LENGTH	THICKNESS	THICKNESS	RANGE		ACTUAL TEETH			
22	19	2	30°		3	RIC9030001		

RIC9031

COLTELLINI REVERSIBILI IN HW
REVERSIBLE KNIVES IN HW

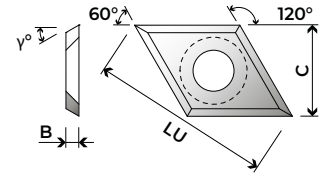

DIMENSIONI DIMENSIONS				ARTICOLI ITEMS		PREZZI €
LU USEFUL LENGTH	C THICKNESS	B THICKNESS	γ° RANGE	Z ACTUAL TEETH	CODICE / SKU	PRICE €
28	14	2	30°	2	RIC9031001	

RIC9032

COLTELLINI REVERSIBILI IN HW
REVERSIBLE KNIVES IN HW

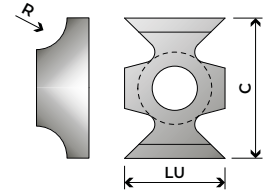

DIMENSIONI DIMENSIONS				ARTICOLI ITEMS		PREZZI €
LU USEFUL LENGTH	C THICKNESS	B THICKNESS	R RADIUS	γ° RANGE	CODICE / SKU	PRICE €
16	22	5	1,5	45°	RIC9032001	
16	22	5	2	45°	RIC9032002	
16	22	5	3	45°	RIC9032003	

RIC9033

COLTELLINI REVERSIBILI IN HW
REVERSIBLE KNIVES IN HW

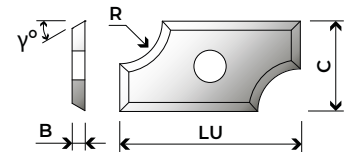

DIMENSIONI DIMENSIONS				ARTICOLI ITEMS		PREZZI €	
LU USEFUL LENGTH	C THICKNESS	B THICKNESS	R RADIUS	γ° RANGE	Z ACTUAL TEETH	CODICE / SKU	PRICE €
19,5	9	1,5	2	35°	2	RIC9033001	
19,5	9	1,5	3	35°	2	RIC9033002	
19,5	9	1,5	5	35°	2	RIC9033003	
24	12	1,5	6,4	35°	2	RIC9033004	
24	12	1,5	8	35°	2	RIC9033006	

RIC9034

COLTELLINI REVERSIBILI IN HW
REVERSIBLE KNIVES IN HW

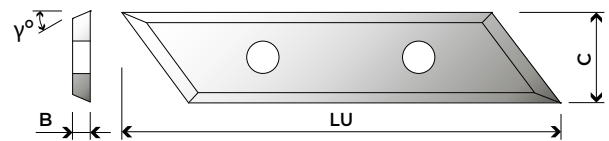

DIMENSIONI DIMENSIONS				ARTICOLI ITEMS		PREZZI €		
LU USEFUL LENGTH	C THICKNESS	B THICKNESS	FT/PH	γ° RANGE	TYPE	Z ACTUAL TEETH	CODICE / SKU	PRICE €
58	12	1,5	2	35°	4 LATI 35°	4	RIC9034001	

RIC9035

COLTELLINI REVERSIBILI IN HW
REVERSIBLE KNIVES IN HW

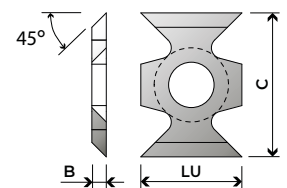

DIMENSIONI DIMENSIONS				ARTICOLI ITEMS		PREZZI €
LU USEFUL LENGTH	C THICKNESS	B THICKNESS	γ° RANGE	Z ACTUAL TEETH	CODICE / SKU	PRICE €
16	22	5	45°		RIC9035001	

RIC9037

COLTELLINI REVERSIBILI IN HW
REVERSIBLE KNIVES IN HW

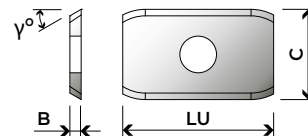

DIMENSIONI		DIMENSIONS			ARTICOLI		ITEMS	PREZZI €
LU	C	B	FT/PH	γ°	TYPE	Z	CODICE / SKU	PRICE €
USEFUL LENGTH	THICKNESS	THICKNESS		RANGE		ACTUAL TEETH		
20	12	1,5	1	35°	2 LATI 35°	2	RIC9037001	
24	12	1,5	1	35°	2 LATI 35°	2	RIC9037002	

RIC9038

COLTELLINI REVERSIBILI IN HW
REVERSIBLE KNIVES IN HW

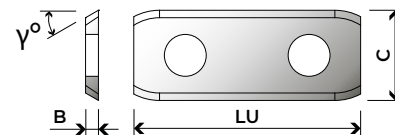

DIMENSIONI		DIMENSIONS			ARTICOLI		ITEMS	PREZZI €
LU	C	B	FT/PH	γ°	TYPE	Z	CODICE / SKU	PRICE €
USEFUL LENGTH	THICKNESS	THICKNESS		RANGE		ACTUAL TEETH		
30	12	1,5	2	35°	2 LATI 35°	2	RIC9038001	
50	12	1,5	2	35°	2 LATI 35°	2	RIC9038002	

RIC9039

COLTELLINI REVERSIBILI IN HW
REVERSIBLE KNIVES IN HW

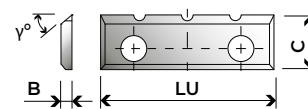

DIMENSIONI		DIMENSIONS			ARTICOLI		ITEMS	PREZZI €
LU	C	B	FT/PH	Z	CODICE / SKU		PRICE €	
USEFUL LENGTH	THICKNESS	THICKNESS		ACTUAL TEETH				
23	7	1,5	2/INT.14	1	RIC9039001			
23	6	1,5	2/INT.14	1	RIC9039002			

RIC9036

COLTELLINI REVERSIBILI IN HW
REVERSIBLE KNIVES IN HW

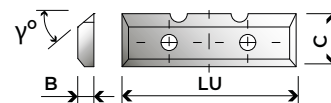

DIMENSIONI		DIMENSIONS			ARTICOLI		ITEMS	PREZZI €
LU	C	B	FT/PH	Z	CODICE / SKU		PRICE €	
USEFUL LENGTH	THICKNESS	THICKNESS		ACTUAL TEETH				
16	7	1,5	2/INT.7	1	RIC9036001			
23	7	1,5	2/INT.14	1	RIC9036002			
23	6	1,5	2/INT.14	1	RIC9036003			

RIC9028

COLTELLINI REVERSIBILI IN HW
REVERSIBLE KNIVES IN HW

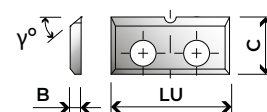

DIMENSIONI		DIMENSIONS			ARTICOLI		ITEMS	PREZZI €
LU	C	B	FT/PH	Z	CODICE / SKU		PRICE €	
USEFUL LENGTH	THICKNESS	THICKNESS		ACTUAL TEETH				
16	7	1,5	2/INT.7	1	RIC9028001			

RIC9015

COLTELLI DA PIALLA KNIFE FOR PLANNER MACHINE

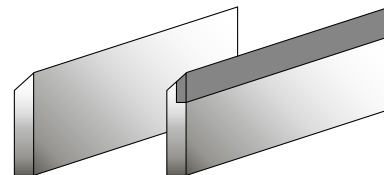

Per testa portacoltelli a piallare con sistema controcoltello. In una confezione sono contenuti 2 coltelli per set bilanciati tra di loro e rettificati. A richiesta sono disponibili in qualsiasi misura con tempi molto brevi di consegna.

In one box there are 2 knives each set, balanced and rectified. On request, they are available in any size with very short delivery time.

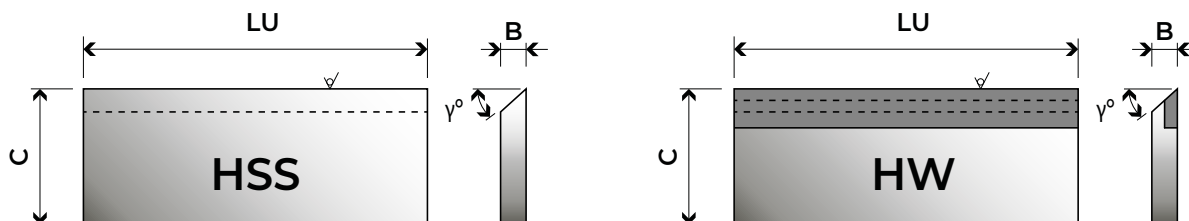

DIMENSIONI DIMENSIONS		ARTICOLI ITEMS					PREZZI €	
		TAGLIANTE CUTTING EDGES	LU USEFUL LENGTH	C THICKNESS	B THICKNESS	γ° RANGE	CODICE / SKU	PRICE €
Coltello pialla Classic	HS:60x30x3	HSS	60	30	3	40°	RIC9015001	
Coltello pialla Classic	HS:80x30x3	HSS	80	30	3	40°	RIC9015002	
Coltello pialla Classic	HS:100x30x3	HSS	100	30	3	40°	RIC9015003	
Coltello pialla Classic	HS:110x30x3	HSS	110	30	3	40°	RIC9015004	
Coltello pialla Classic	HS:120x30x3	HSS	120	30	3	40°	RIC9015005	
Coltello pialla Classic	HS:130x30x3	HSS	130	30	3	40°	RIC9015006	
Coltello pialla Classic	HS:150x30x3	HSS	150	30	3	40°	RIC9015007	
Coltello pialla Classic	HS:160x30x3	HSS	160	30	3	40°	RIC9015008	
Coltello pialla Classic	HS:170x30x3	HSS	170	30	3	40°	RIC9015009	
Coltello pialla Classic	HS:180x30x3	HSS	180	30	3	40°	RIC9015010	
Coltello pialla Classic	HS:190x30x3	HSS	190	30	3	40°	RIC9015011	
Coltello pialla Classic	HS:210x30x3	HSS	210	30	3	40°	RIC9015012	
Coltello pialla Classic	HS:230x30x3	HSS	230	30	3	40°	RIC9015013	
Coltello pialla Classic	HS:240x30x3	HSS	240	30	3	40°	RIC9015014	
Coltello pialla Classic	HS:250x30x3	HSS	250	30	3	40°	RIC9015015	
Coltello pialla Classic	HS:260x30x3	HSS	260	30	3	40°	RIC9015016	
Coltello pialla Classic	HS:270x30x3	HSS	270	30	3	40°	RIC9015017	
Coltello pialla Classic	HS:310x30x3	HSS	310	30	3	40°	RIC9015018	
Coltello pialla Classic	HS:320x30x3	HSS	320	30	3	40°	RIC9015019	
Coltello pialla Classic	HS:360x30x3	HSS	360	30	3	40°	RIC9015020	
Coltello pialla Classic	HS:400x30x3	HSS	400	30	3	40°	RIC9015021	
Coltello pialla Classic	HS:410x30x3	HSS	410	30	3	40°	RIC9015022	
Coltello pialla Classic	HS:460x30x3	HSS	460	30	3	40°	RIC9015023	
Coltello pialla Classic	HS:500x30x3	HSS	500	30	3	40°	RIC9015024	
Coltello pialla Classic	HS:510x30x3	HSS	510	30	3	40°	RIC9015025	
Coltello pialla Classic	HS:600x30x3	HSS	600	30	3	40°	RIC9015026	
Coltello pialla Classic	HS:610x30x3	HSS	610	30	3	40°	RIC9015027	
Coltello pialla Classic	HS:630x30x3	HSS	630	30	3	40°	RIC9015028	
Coltello pialla Classic	HS:640x30x3	HSS	640	30	3	40°	RIC9015029	
Coltello pialla Classic	HS:710x30x3	HSS	710	30	3	40°	RIC9015030	
Coltello pialla Classic	HS:810x30x3	HSS	810	30	3	40°	RIC9015031	
Coltello pialla HW	HW:60x30x3	HSS	60	30	3	45°	RIC9015032	
Coltello pialla HW	HW:80x30x3	HW	80	30	3	45°	RIC9015033	
Coltello pialla HW	HW:100x30x3	HW	100	30	3	45°	RIC9015034	
Coltello pialla HW	HW:110x30x3	HW	110	30	3	45°	RIC9015035	
Coltello pialla HW	HW:120x30x3	HW	120	30	3	45°	RIC9015036	
Coltello pialla HW	HW:130x30x3	HW	130	30	3	45°	RIC9015037	
Coltello pialla HW	HW:150x30x3	HW	150	30	3	45°	RIC9015038	
Coltello pialla HW	HW:170x30x3	HW	170	30	3	45°	RIC9015039	
Coltello pialla HW	HW:180x30x3	HW	180	30	3	45°	RIC9015040	



		DIMENSIONI DIMENSIONS					ARTICOLI ITEMS	PREZZI €
	TAGLIANTE CUTTING EDGES	LU USEFUL LENGTH	C THICKNESS	B THICKNESS	γ° RANGE	CODICE / SKU	PRICE €	
Coltello pialla HW	HW:210x30x3	HW	210	30	3	45°	RIC9015041	
Coltello pialla HW	HW:230x30x3	HW	230	30	3	45°	RIC9015042	
Coltello pialla HW	HW:260x30x3	HW	260	30	3	45°	RIC9015043	
Coltello pialla HW	HW:310x30x3	HW	310	30	3	45°	RIC9015044	
Coltello pialla HW	HW:360x30x3	HW	360	30	3	45°	RIC9015045	
Coltello pialla HW	HW:410x30x3	HW	410	30	3	45°	RIC9015046	
Coltello pialla HW	HW:460x30x3	HW	460	30	3	45°	RIC9015047	
Coltello pialla HW	HW:510x30x3	HW	510	30	3	45°	RIC9015048	
Coltello pialla HW	HW:610x30x3	HW	610	30	3	45°	RIC9015049	
Coltello pialla HW	HW:630x30x3	HW	630	30	3	45°	RIC9015050	
Coltello pialla HW	HW:640x30x3	HW	640	30	3	45°	RIC9015051	
Coltello pialla HW	HW:710x30x3	HW	710	30	3	45°	RIC9015052	
Coltello pialla HW	HW:810x30x3	HW	810	30	3	45°	RIC9015053	
Coltello pialla Classic	HS:60x35x3	HSS	60	35	3	40°	RIC9015054	
Coltello pialla Classic	HS:100x35x3	HSS	100	35	3	40°	RIC9015055	
Coltello pialla Classic	HS:160x35x3	HSS	160	35	3	40°	RIC9015056	
Coltello pialla Classic	HS:230x35x3	HSS	230	35	3	40°	RIC9015057	
Coltello pialla Classic	HS:310x35x3	HSS	310	35	3	40°	RIC9015058	
Coltello pialla Classic	HS:320x35x3	HSS	320	35	3	40°	RIC9015059	
Coltello pialla Classic	HS:330x35x3	HSS	330	35	3	40°	RIC9015060	
Coltello pialla Classic	HS:360x35x3	HSS	360	35	3	40°	RIC9015061	
Coltello pialla Classic	HS:400x35x3	HSS	400	35	3	40°	RIC9015062	
Coltello pialla Classic	HS:410x35x3	HSS	410	35	3	40°	RIC9015063	
Coltello pialla Classic	HS:450x35x3	HSS	450	35	3	40°	RIC9015064	
Coltello pialla Classic	HS:460x35x3	HSS	460	35	3	40°	RIC9015065	
Coltello pialla Classic	HS:500x35x3	HSS	500	35	3	40°	RIC9015066	
Coltello pialla Classic	HS:510x35x3	HSS	510	35	3	40°	RIC9015067	
Coltello pialla Classic	HS:520x35x3	HSS	520	35	3	40°	RIC9015068	
Coltello pialla Classic	HS:530x35x3	HSS	530	35	3	40°	RIC9015069	
Coltello pialla Classic	HS:600x35x3	HSS	600	35	3	40°	RIC9015070	
Coltello pialla Classic	HS:610x35x3	HSS	610	35	3	40°	RIC9015071	
Coltello pialla Classic	HS:630x35x3	HSS	630	35	3	40°	RIC9015072	
Coltello pialla Classic	HS:635x35x3	HSS	635	35	3	40°	RIC9015073	
Coltello pialla Classic	HS:640x35x3	HSS	640	35	3	40°	RIC9015074	
Coltello pialla Classic	HS:700x35x3	HSS	700	35	3	40°	RIC9015075	
Coltello pialla Classic	HS:710x35x3	HSS	710	35	3	40°	RIC9015076	
Coltello pialla Classic	HS:740x35x3	HSS	740	35	3	40°	RIC9015077	
Coltello pialla Classic	HS:810x35x3	HSS	810	35	3	40°	RIC9015078	
Coltello pialla HW	HW:310x35x3	HW	310	35	3	45°	RIC9015079	
Coltello pialla HW	HW:320x35x3	HW	320	35	3	45°	RIC9015080	
Coltello pialla HW	HW:330x35x3	HW	330	35	3	45°	RIC9015081	
Coltello pialla HW	HW:360x35x3	HW	360	35	3	45°	RIC9015082	
Coltello pialla HW	HW:400x35x3	HW	400	35	3	45°	RIC9015083	
Coltello pialla HW	HW:410x35x3	HW	410	35	3	45°	RIC9015084	
Coltello pialla HW	HW:450x35x3	HW	450	35	3	45°	RIC9015085	
Coltello pialla HW	HW:460x35x3	HW	460	35	3	45°	RIC9015086	
Coltello pialla HW	HW:500x35x3	HW	500	35	3	45°	RIC9015087	
Coltello pialla HW	HW:510x35x3	HW	510	35	3	45°	RIC9015088	
Coltello pialla HW	HW:520x35x3	HW	520	35	3	45°	RIC9015089	
Coltello pialla HW	HW:530x35x3	HW	530	35	3	45°	RIC9015090	
Coltello pialla HW	HW:600x35x3	HW	600	35	3	45°	RIC9015091	
Coltello pialla HW	HW:610x35x3	HW	610	35	3	45°	RIC9015092	
Coltello pialla HW	HW:630x35x3	HW	630	35	3	45°	RIC9015093	
Coltello pialla HW	HW:635x35x3	HW	635	35	3	45°	RIC9015094	
Coltello pialla HW	HW:640x35x3	HW	640	35	3	45°	RIC9015095	
Coltello pialla HW	HW:700x35x3	HW	700	35	3	45°	RIC9015096	
Coltello pialla HW	HW:710x35x3	HW	710	35	3	45°	RIC9015097	
Coltello pialla HW	HW:740x35x3	HW	740	35	3	45°	RIC9015098	
Coltello pialla HW	HW:810x35x3	HW	810	35	3	45°	RIC9015099	

RIC9009

SPESSORI SPACERS

Anelli distanziatori ad esecuzione tranciata senza rettifica.

Spacers rings no rectified.

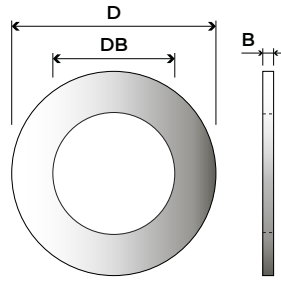

RIC9017

SPESSORI SPACERS

Anelli distanziatori.

Spacers rings.

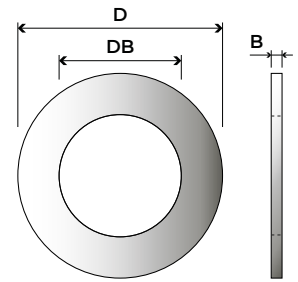

DIMENSIONI DIMENSIONS			ARTICOLI ITEMS	PREZZI €
DB H. DIAMETER	D DIAMETER	B THICKNESS	CODICE / SKU	PRICE €
12	50	0,1	RIC9009001	
12	50	0,2	RIC9009002	
12	50	0,3	RIC9009003	
12	50	0,5	RIC9009004	
12	50	1	RIC9009005	
16	50	0,1	RIC9009006	
16	50	0,2	RIC9009007	
16	50	0,3	RIC9009008	
16	50	0,5	RIC9009009	
16	50	1	RIC9009010	
20	50	0,1	RIC9009011	
20	50	0,2	RIC9009012	
20	50	0,3	RIC9009013	
20	50	0,5	RIC9009014	
20	50	1	RIC9009015	
22	50	0,1	RIC9009016	
22	50	0,2	RIC9009017	
22	50	0,3	RIC9009018	
22	50	0,5	RIC9009019	
22	50	1	RIC9009020	
30	50	0,1	RIC9009021	
30	50	0,2	RIC9009022	
30	50	0,3	RIC9009023	
30	50	0,5	RIC9009024	
30	50	1	RIC9009025	
35	55	0,1	RIC9009026	
35	55	0,2	RIC9009027	
35	55	0,3	RIC9009028	
35	55	0,5	RIC9009029	
35	55	1	RIC9009030	
40	60	0,1	RIC9009031	
40	60	0,2	RIC9009032	
40	60	0,3	RIC9009033	
40	60	0,5	RIC9009034	
40	60	1	RIC9009035	
50	70	0,1	RIC9009036	
50	70	0,2	RIC9009037	
50	70	0,3	RIC9009038	
50	70	0,5	RIC9009039	
50	70	1	RIC9009040	
60	80	0,1	RIC9009041	
60	80	0,2	RIC9009042	
60	80	0,3	RIC9009043	
60	80	0,5	RIC9009044	
60	80	1	RIC9009045	
65	85	0,1	RIC9009046	
65	85	0,2	RIC9009047	
65	85	0,3	RIC9009048	
65	85	0,5	RIC9009049	
65	85	1	RIC9009050	
70	90	0,1	RIC9009051	
70	90	0,2	RIC9009052	
70	90	0,3	RIC9009053	
70	90	0,5	RIC9009054	
70	90	1	RIC9009055	

DIMENSIONI DIMENSIONS			ARTICOLI ITEMS	PREZZI €
DB H. DIAMETER	D DIAMETER	B THICKNESS	CODICE / SKU	PRICE €
16	35	2	RIC9017001	
16	35	5	RIC9017002	
16	35	10	RIC9017003	
16	35	20	RIC9017004	
20	40	2	RIC9017005	
20	40	5	RIC9017006	
20	40	10	RIC9017007	
20	40	20	RIC9017008	
30	50	2	RIC9017009	
30	50	3	RIC9017010	
30	50	5	RIC9017011	
30	50	10	RIC9017012	
30	50	20	RIC9017013	
35	55	3	RIC9017014	
35	55	5	RIC9017015	
35	55	10	RIC9017016	
35	55	20	RIC9017017	
40	60	2	RIC9017018	
40	60	5	RIC9017019	
40	60	10	RIC9017020	
40	60	20	RIC9017021	
50	70	2	RIC9017022	
50	70	5	RIC9017023	
50	70	10	RIC9017024	
50	70	20	RIC9017025	
60	80	2	RIC9017026	
60	80	5	RIC9017027	
60	80	10	RIC9017028	
60	80	20	RIC9017029	
70	90	2	RIC9017030	
70	90	5	RIC9017031	
70	90	10	RIC9017032	
70	90	20	RIC9017033	

RIC9018

SPESSORI SPACERS

Anelli distanziatori con doppia chiavetta.

Spacers rings with double key.

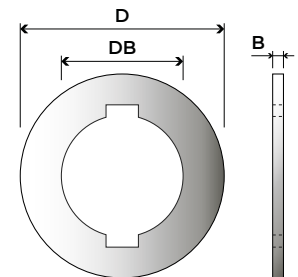

DIMENSIONI DIMENSIONS			ARTICOLI ITEMS	PREZZI €	
DB H. DIAMETER	D DIAMETER	B THICKNESS	DNK	CODICE / SKU	PRICE €
30	50	2	2	RIC9018001	
35	65	2	2	RIC9018002	
40	70	2	2	RIC9018003	

RIC9007

VITI SCREW

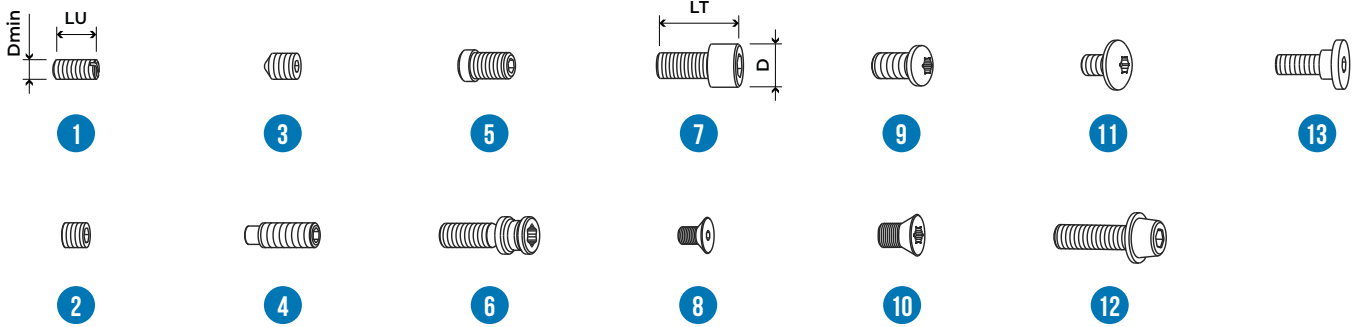

		DIMENSIONI DIMENSIONS				ARTICOLI ITEMS			PREZZI €	
DESCRIZIONE	D MIN	D	LU	LT	TIPO	CHIAVE "T"	TYPE+CHIAVE	CONF. DA:	CODICE / SKU	PRICE €
Dmin X LU X LT	MIN DIAMETER	DIAMETER	USEFUL LENGTH	TOTAL LENGTH	TYPE			PACK OF:		
M5X8	M5		8		1		1	10	RIC9007001	
M5X10	M5		10		1		1	10	RIC9007002	
M2X2	M2		2		2		2	10	RIC9007003	
M4X4	M4		4		2		2	10	RIC9007142	
M4X6	M4		6		2		2	10	RIC9007135	
M4X20	M4		20		2		2	10	RIC9007004	
M5X4	M5		4		2		2	10	RIC9007005	
M5X5	M5		5		2		2	10	RIC9007006	
M3X3	M3		3		2		2	10	RIC9007112	
M4X5	M4		5		2		2	10	RIC9007113	
M4X12	M4		12		2		2	10	RIC9007114	
M4X14	M4		14		2		2	10	RIC9007115	
M5X6	M5		6		2		2	10	RIC9007116	
M5X10	M5		10		2		2	10	RIC9007117	
M5X15	M5		15		2		2	10	RIC9007118	
M5X20	M5		20		2		2	10	RIC9007119	
M6X5	M6		5		2		2	10	RIC9007143	
M6X6	M6		6		2		2	10	RIC9007120	
M6X8	M6		8		2		2	10	RIC9007121	
M6X10	M6		10		2		2	10	RIC9007122	
M6X12	M6		12		2		2	10	RIC9007123	
M6X14	M6		14		2		2	10	RIC9007124	
M6X16	M6		16		2		2	10	RIC9007125	
M6X25	M6		25		2		2	10	RIC9007136	
M10X12	M10		12		2		2	10	RIC9007126	
M3X3	M3		3		3		3	10	RIC9007008	
M5X5	M5		5		3		3	10	RIC9007009	
M6X6	M6		6		3		3	10	RIC9007010	
M4X3	M4		3		3		3	10	RIC9007011	
M4X4	M4		4		3		3	10	RIC9007012	
M6X5	M6		5		3		3	10	RIC9007013	
M4X4X6	M4		4	6	4		4	10	RIC9007134	
M5X4X6	M5		4	6	4		4	10	RIC9007128	
M6X6X8	M6		6	8	4		4	10	RIC9007129	
M6X8X12	M6		8	12	4		4	10	RIC9007014	
M6X10X16	M6		10	16	4		4	10	RIC9007015	
M6X16X20	M6		16	20	4		4	10	RIC9007016	
M6X20	M6		20		4		4	10	RIC9007017	
M6X25	M6		25		4		4	10	RIC9007018	
M8X5X10	M8		5	10	4		4	10	RIC9007130	

DESCRIZIONE		DIMENSIONI / DIMENSIONS				ARTICOLI / ITEMS			PREZZI €	
Dmin X LU X LT	D MIN MIN DIAMETER	D DIAMETER	LU USEFUL LENGTH	LT TOTAL LENGTH	TIPO TYPE	CHIAVE "T"	TYPE+CHIAVE	CONF. DA: PACK OF:	CODICE / SKU	PRICE €
M8X8X10	M8		8	10	4		4	10	RIC9007131	
M8X10X16	M8		10	16	4		4	10	RIC9007132	
M8X12	M8		12		4		4	10	RIC9007019	
M8X16X20	M8		16	20	4		4	10	RIC9007020	
M8X20	M8		20		4		4	10	RIC9007021	
M10X8X15	M10		8	15	4		4	10	RIC9007133	
M5X5X9	M5	6	5	9	5		5	10	RIC9007022	
M5X11X17	M5		11	17	6		6	10	RIC9007023	
M2,5X6X8,5	M2,5	4,5	6	8,5	7		7	10	RIC9007024	
M3X6X9	M3	5,5	6	9	7		7	10	RIC9007025	
M3X10X13	M3	5,5	10	13	7		7	10	RIC9007026	
M3X13X16	M3	5,5	13	16	7		7	10	RIC9007058	
M3X16X19	M3	5,5	16	19	7		7	10	RIC9007027	
M4X6X10	M4	7	6	10	7		7	10	RIC9007028	
M4X8X12	M4	7	8	12	7		7	10	RIC9007147	
M4X10X14	M4	7	10	14	7		7	10	RIC9007060	
M4X12X16	M4	7	12	16	7		7	10	RIC9007029	
M3X20X28	M3	7	20	28	7		7	10	RIC9007078	
M4X16X20	M4	7	16	20	7		7	10	RIC9007148	
M4X20X34	M4	7	20	34	7		7	10	RIC9007079	
M4X12X16	M4	7	12	16	7		7	10	RIC9007061	
M6X25X31	M6	10	25	31	7		7	10	RIC9007030	
M8X25X33	M8	13	25	33	7		7	10	RIC9007031	
M1/8"X1,2"X5,8"	M1/8"	5,5	1,2"	5,8"	7		7	10	RIC9007032	
M5X10X15	M5	8,5	10	15	7		7	10	RIC9007033	
M5X15X20	M5	8,5	15	20	7		7	10	RIC9007062	
M5X20X25	M5	8,5	20	25	7		7	10	RIC9007063	
M5X25X30	M5	8,5	25	30	7		7	10	RIC9007064	
M6X10X15	M6	10	10	15	7		7	10	RIC9007065	
M5X23X35	M5	8,5	23	35	7		7	10	RIC9007080	
M5X23X65	M5	8,5	23	65	7		7	10	RIC9007081	
M6X14X20	M6	10	14	20	7		7	10	RIC9007066	
M6X16X22	M6	10	16	22	7		7	10	RIC9007067	
M6X20X25	M6	10	20	25	7		7	10	RIC9007068	
M6X13X22	M6	13	13	22	7		7	10	RIC9007069	
M6X16X24	M6	13	16	24	7		7	10	RIC9007070	
M6X25X56	M6	13	25	56	7		7	10	RIC9007082	
M6X16X66	M6	13	16	66	7		7	10	RIC9007083	
M6X18X76	M6	13	18	76	7		7	10	RIC9007084	
M6X27X76	M6	13	27	76	7		7	10	RIC9007085	
M6X25X85	M6	13	25	85	7		7	10	RIC9007086	
M6X25X105	M6	13	25	105	7		7	10	RIC9007087	
M8X20X28	M8	13	20	28	7		7	10	RIC9007071	
M8X22X30	M8	13	22	30	7		7	10	RIC9007072	
M8X30X38	M8	13	30	38	7		7	10	RIC9007073	
M8X15X25	M8	16	15	25	7		7	10	RIC9007074	
M8X20X30	M8	16	20	30	7		7	10	RIC9007075	
M8X30X40	M8	16	30	40	7		7	10	RIC9007076	
M8X30X47	M8	16	30	47	7		7	10	RIC9007088	
M8X30X57	M8	16	30	57	7		7	10	RIC9007089	
M8X30X68	M8	16	30	68	7		7	10	RIC9007090	
M8X30X78	M8	16	30	78	7		7	10	RIC9007091	
M8X30X88	M8	16	30	88	7		7	10	RIC9007092	
M8X30X98	M8	16	30	98	7		7	10	RIC9007093	
M4X4X6	M4	8	4	6	8		8	10	RIC9007034	
M4X5X8	M4	8	5	8	8		8	10	RIC9007094	
M4X6X10	M4	8	6	10	8		8	10	RIC9007095	
M4X8X12	M4	8	8	12	8		8	10	RIC9007096	

DIMENSIONI DIMENSIONS										ARTICOLI ITEMS	PREZZI €
DESCRIZIONE	D MIN	D	LU	LT	TIPO	CHIAVE "T"	TYPE+CHIAVE	CONF. DA:	CODICE / SKU	PRICE €	
Dmin X LU X LT	MIN DIAMETER	DIAMETER	USEFUL LENGTH	TOTAL LENGTH	TYPE			PACK OF:			
M5X3X6	M5	9,7	3	6	8		8	10	RIC9007097		
M5X6X10	M5	9,7	6	10	8		8	10	RIC9007098		
M5X12X16	M5	9,7	12	16	8		8	10	RIC9007099		
M5X15X20	M5	9,7	15	20	8		8	10	RIC9007100		
M5X25X30	M5	9,7	25	30	8		8	10	RIC9007101		
M6X10X16	M6	11,7	10	16	8		8	10	RIC9007102		
M6X15X20	M6	11,7	15	20	8		8	10	RIC9007103		
M6X20X25	M6	11,7	20	25	8		8	10	RIC9007104		
M6X25X30	M6	11,7	25	30	8		8	10	RIC9007105		
M6X35X40	M6	11,7	35	40	8		8	10	RIC9007106		
M6X45X50	M6	11,7	45	50	8		8	10	RIC9007107		
M8X15X20	M8	15,7	15	20	8		8	10	RIC9007108		
M8X22X30	M8	15,7	22	30	8		8	10	RIC9007109		
M8X93X100	M8	15,7	93	100	8		8	10	RIC9007110		
M10X22X30	M10	19,7	22	30	8		8	10	RIC9007111		
M5X9X12	M5	10	9	12	8		8	10	RIC9007035		
M5X5X8	M5	9	5	8	8		8	10	RIC9007036		
M6X8X10	M6	9	8	10	8		8	10	RIC9007037		
M6X35X40	M6	12	35	40	8		8	10	RIC9007146		
M10X20X35	M10	24	20	35	13		13	10	RIC9007059		
M1/4"X- 11/16"X7/8"	M1/4"	12	11/16"	7/8"	9		9	10	RIC9007038		
M3X4X6	M3	5,4	4	6	9	T9	9 CHIAVE T9	10	RIC9007145		
M1/8"X3/8"X1/2"	M1/8"	7	3/8"	1/2"	12		12	10	RIC9007039		
M5X13X18	M5	6,8	13	18	10	T15	10 CHIAVE T15	10	RIC9007040		
M3X4X5,7	M3	4,6	4	5,7	9	T8	9 CHIAVE T8	10	RIC9007041		
M3,5X5X8,2	M3,5	6	5	8,2	11	T15	11 CHIAVE T15	10	RIC9007042		
M2,5X3X4,5	M2,5	3,5	3	4,5	10	T8	10 CHIAVE T8	10	RIC9007043		
M2,5X4X6	M2,5	3,7	4	6	10	T8	10 CHIAVE T8	10	RIC9007044		
M4X2X3	M4	6	2	3	10	T9	10 CHIAVE T9	10	RIC9007045		
M5X3X6,1	M5	8,8	3	6,1	10	T25	10 CHIAVE T25	10	RIC9007046		
M5X5X8	M5	9	5	8	10	T25	10 CHIAVE T25	10	RIC9007047		
M3,5X3X6	M3,5	6	3	6	11	T15	11 CHIAVE T15	10	RIC9007048		
M3,5X6X8	M3,5	7	6	8	11	T15	11 CHIAVE T15	10	RIC9007137		
M3,5X5X7,2	M3,5	8,8	5	7,2	11	T15	11 CHIAVE T15	10	RIC9007049		
M4X3X5,7	M4	8,8	3	5,7	11	T15	11 CHIAVE T15	10	RIC9007050		
M4X4X6,2	M4	5,8	4	6,2	11	T15	11 CHIAVE T15	10	RIC9007051		
M4X4X6,2	M4	8,8	4	6,2	11	T15	11 CHIAVE T15	10	RIC9007052		
M4X5X8	M4	7,4	5	8	9	T20	9 CHIAVE T20	10	RIC9007053		
M4X6X8	M4	6	6	8	11	T15	11 CHIAVE T15	10	RIC9007054		
M4X6X8,2	M4	9	6	8,2	11	T15	11 CHIAVE T15	10	RIC9007055		
M5X6X11,5	M5	7	6	11,5	10	T20	10 CHIAVE T20	10	RIC9007056		
M5X8X10	M5	9	8	10	10	T20	10 CHIAVE T20	10	RIC9007057		
M7X7X14	M7	9	7	14	10	T30	10 CHIAVE T30	10	RIC9007127		
M5X3X6,5	M5	8,6	3	6,5	8		8	10	RIC9007144		
SPINA D3X4		3		4	14		14	10	RIC9007138		
SPINA D3X6		3		6	14		14	10	RIC9007139		
SPINA D4X6		4		6	14		14	10	RIC9007140		
SPINA D4X8		4		8	14		14	10	RIC9007141		

CARATTERISTICHE TECNICHE TECHNICAL FEATURES

NUMERO ELICHE RELATIVE ALL'UTENSILE Numbers of wings according to the tools



Z EFFETTIVI IN PRESA Engaged tips



ALTEZZA PCD PCD height



TIPOLOGIA TAGLIANTE Type of cutting

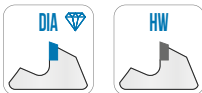

TIPOLOGIA CORPO FRESA Type of tool body



GEOMETRIA DI AFFILATURA Sharpening type

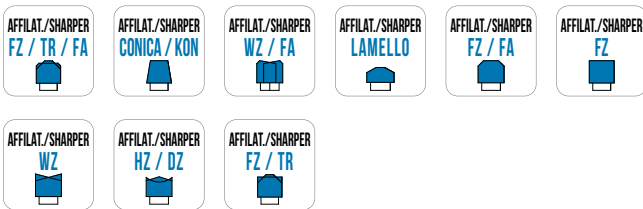

ANGOLO ASSIALE DELL'UTENSILE Axial angle of tool



NUMERO DI GIRI MASSIMO Max. R.P.M.

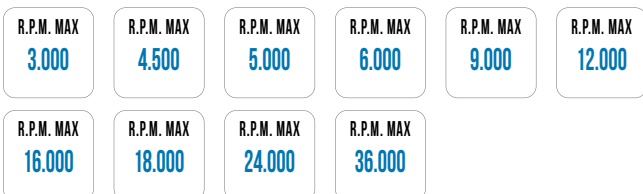

TIPOLOGIA LAVORAZIONE Working operations

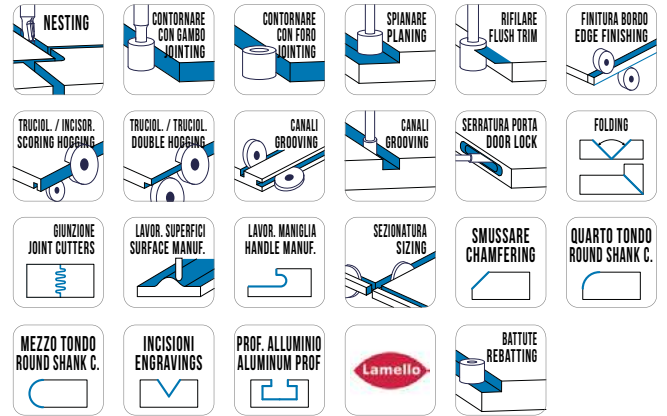

SISTEMA ROMPI TRUCIOLO SUL TAGLIANTE Chip breaker system



TIPOLOGIA AVANZAMENTO Feeding system

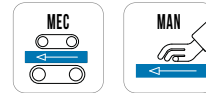

SISTEMA CON ASOLE ANTIRUMORE Anti-noise system



ASSIALE ELICA POSITIVO / NEGATIVO Axial wing positive / negative



ROTAZIONE Rotation

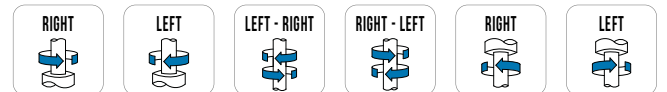

TIPOLOGIA FORANTE Type of Plung tip



TIPOLOGIA FORO DELLA PUNTA FORATRICE Type of Drilling bit



ANGOLO TAGLIO DELLA LAMA Cutting angle of saw blade



LIMITATORE DI TRUCIOLO Chip limiter



BASSOFONDI - TYPE

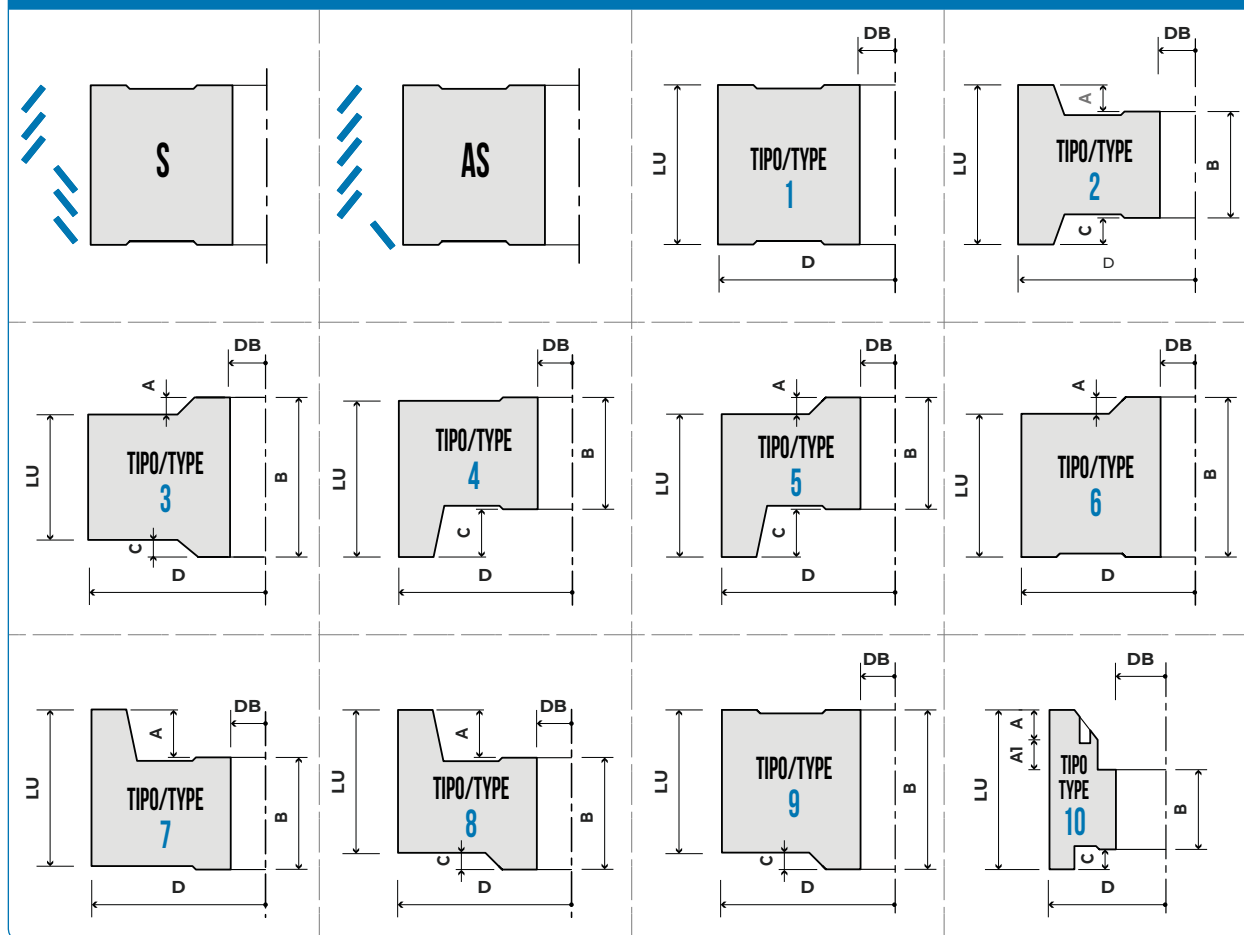

INDICE MATERIALI INDEX MATERIAL



MICROTECH

Via Leonardo Da Vinci 21

62010 **Appignano** (MC) - ITALY

 Tel: +39 **0733 57879** / +39 **0733 579649**

 Fax: +39 0733 579649

 microtechdia@microtechdia.com

 www.microtechdia.com

UFFICIO COMMERCIALE ITALIA



LUCA Carciofi

 l.carciofi@microtechdia.com

  +39 **333 321 8304**



ORLANDO Carciofi

 o.carciofi@microtechdia.com

  +39 **338 292 0008**



FABRIZIO Raponi

 f.raponi@microtechdia.com

  +39 **327 738 0460**

ELENA Borri

 commerciale@microtechdia.com

  +39 **328 037 3324**

EXPORT DEPARTMENT

GABRIELE Borri

 g.borri@microtechdia.com

  +39 **338 753 3716**



LAURA Borri

 l.borri@microtechdia.com

  +39 **339 375 1977**

FELICE Longhi

 f.longhi@microtechdia.com

  +39 **345 921 6190**

NEW B2B **STORE.MICROTECHDIA**





 **MICROTECH**®
HIGH PERFORMANCE TOOLS

NEW B2B **STORE.MICROTECHDIA**

MICROTECH

Via Leonardo Da Vinci 21
62010 Appignano (MC)

Tel: +39 **0733 57879** / +39 **0733 579649**

Fax: +39 0733 579649

microtechdia@microtechdia.com
www.microtechdia.com